

HITACHI

Inspire the Next

46" LCD Colour Television

Instructions for use

GB

L46VN05U

HDMI™
HIGH-DEFINITION MULTIMEDIA INTERFACE

digital 
Approved product

FULL HD 1080



HITACHI

IMPORTANT - If placing TV into cabinet or alcove, ensure there is at least a 100mm (10cm) gap to the sides, rear and top of the TV. This is to allow for adequate ventilation during operation. Please read the main Users Guide for more safety information before installation.

1 **insert the batteries into your handset**



Rear view

2a **either connect the aerial straight to your TV...**

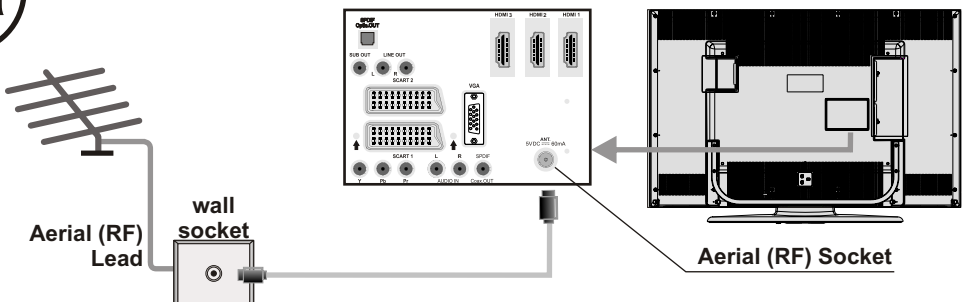

Aerial (RF) Lead

wall socket

Aerial (RF) Socket

2b **...or connect the aerial through a VCR...**

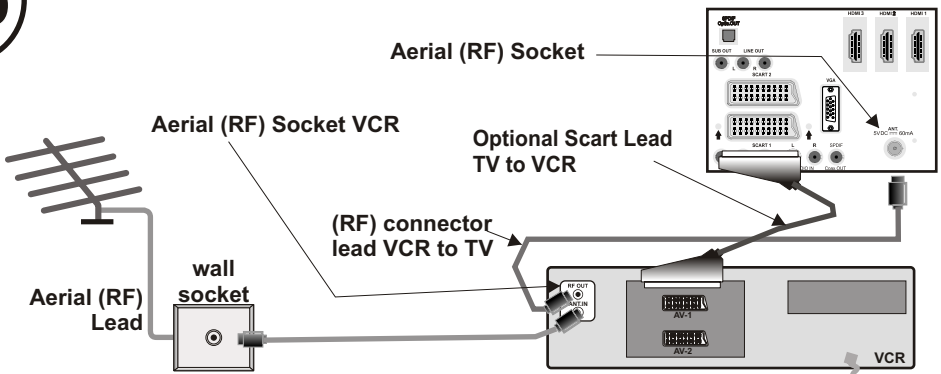

Aerial (RF) Socket

Aerial (RF) Socket VCR

Optional Scart Lead TV to VCR

(RF) connector lead VCR to TV

Aerial (RF) Lead

wall socket

VCR

• It is recommended that a scart lead should be fitted between your TV and VCR to enhance your picture and sound quality. Scart leads are essential if you have a stereo TV and VCR and wish to obtain stereo sound from your equipment. These leads can be purchased from your Hitachi dealer or any good High Street electrical retailer.

2c

...or through a HDMI and YPBPr products (DVD-RW)

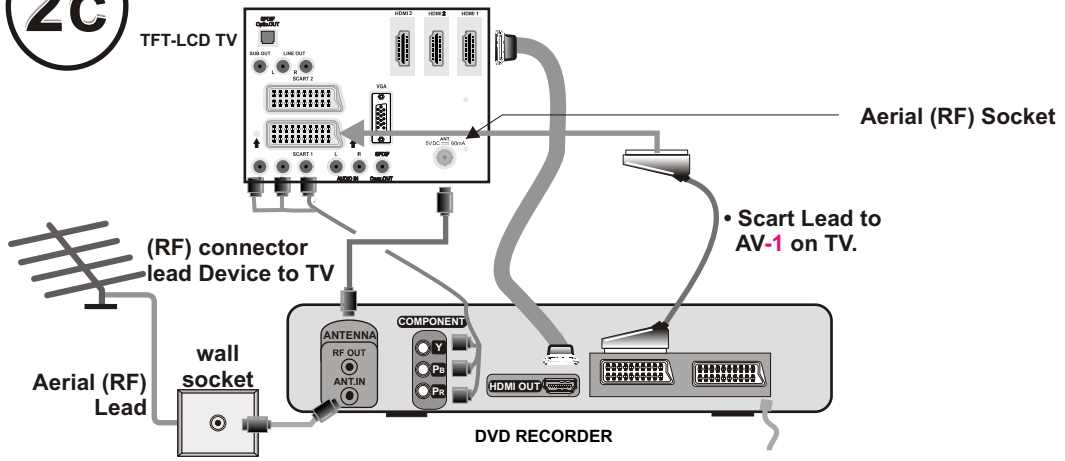

• High Definition

Your LCD Television is capable of displaying High Definition pictures from devices such as a High Definition Satellite Receiver or DVD Device. These devices must be connected via the HDMI socket or Component Socket.

2d

...or through a VCR and satellite decoder.

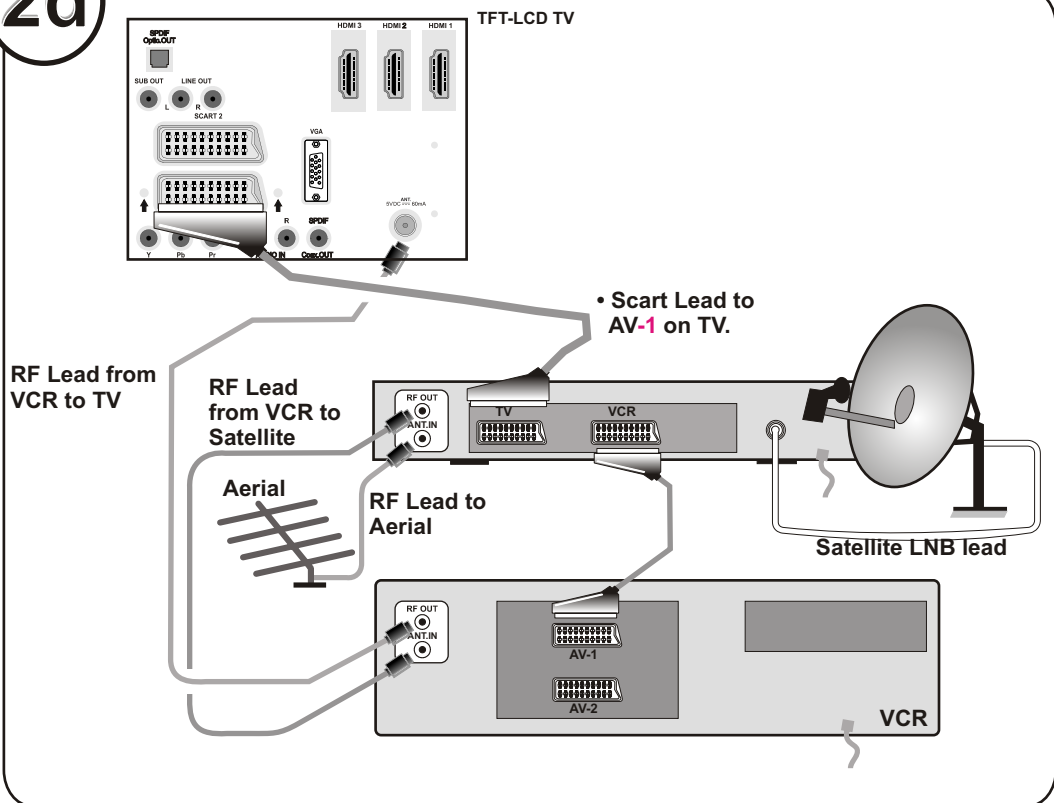

3

connect the TV plug to the mains socket

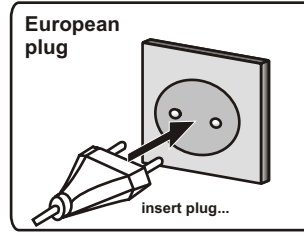
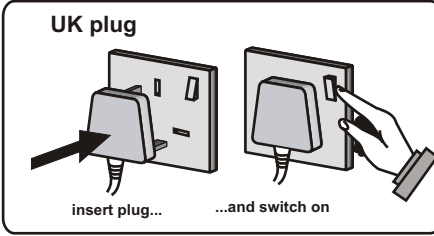

4

switch your TV on by setting the on/off button to position | .

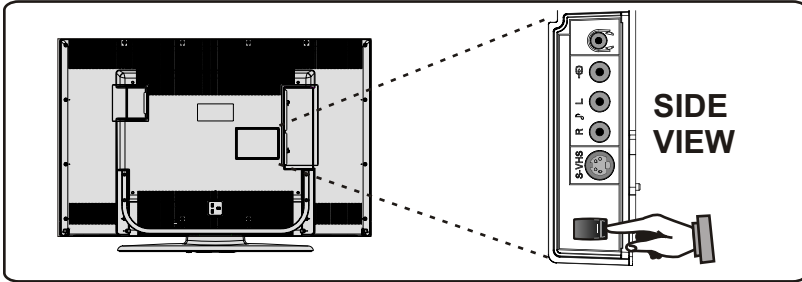

NB: When the set is first switched on, the set will be in standby and the indicator on the front of the set will illuminate red. Press Operate/Standby or channel up down (P-, P+) or numeric buttons (1, 2, 3, ...) to operate.

basic functions of remote control

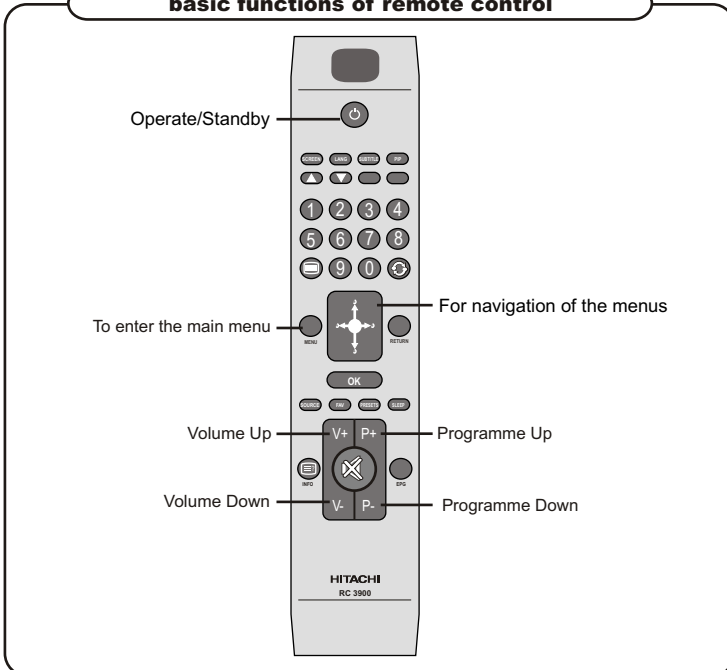

5

start A.P.S. (Auto Programming System)

1

When the TV is turned on for the first time, the menu for the language selection appears on the screen. The message **"Welcome please select your language!"** is written in all language options sequentially in the menu on the screen. By pressing ▲ or ▼ buttons highlight the language you want to set and press **OK**. After then, **First time Installation Menu** will appear on screen. By pressing ◀ or ▶ buttons, select country item you want to set and press **OK** button.



2

After the First Time Installation is set, the following message appears on the screen. **Do you want to start an automatic channel scan?** To start automatic search, select **"Yes"**, to cancel select **"No"**. This process will take about five minutes. To cancel searching, you can press **"MENU"** button at any time during the process.

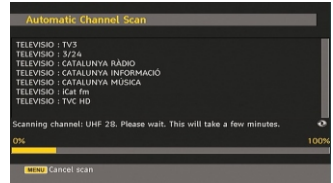

3

After **Automatic Search** process is completed, a message asking for analogue channel search appears on the screen. To continue Auto Program, first set the language, country and teletext language by using ◀ or ▶ button and then press the **RED** or **OK** button

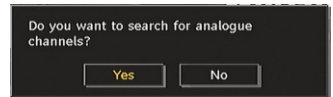

4

After APS is finalized, the programme table will appear on the screen. In the programme list you will see the programme numbers and names assigned to the programmes.

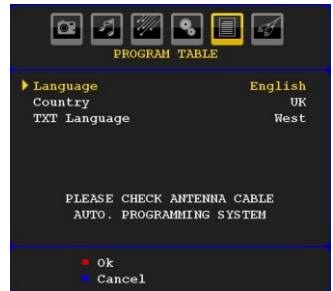

5

For details, please refer to the **Install Menu** section of the instruction book.

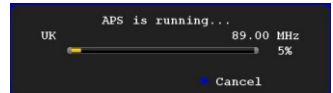

important note.

Once the TV has found all your local stations, they are then automatically assigned a programme number and name, if available from the broadcast.



Contents

Features	3	Deleting the Channels in the Channel List....	24
Introduction.....	4	Renaming Channels	25
Preparation.....	4	Adding Locks to Channels	25
Safety Precautions	4	Setting Favourites.....	25
Power Source	5	How to Add a Channel to a Favourites List	26
Power Cord.....	5	Removing a Channel from Favourite List	26
Warning	5	On Screen Help	26
Disconnecting the Device	5	Program Guide	26
Moisture and Water	5	Timers.....	26
Cleaning.....	5	Conditional Access	26
Ventilation	5	TV Setup.....	27
Heat and Flames	5	Setup	27
Lightning	5	Configuration	27
Replacement Parts	6	Dolby D Digital (*for EU countries except	
Servicing.....	6	UK)	27
Waste Disposal.....	6	Hard of Hearing (*for EU countries except	
Information for Users in European Union Coun-		UK)	27
tries.....	6	Favourite Mode.....	28
Headphone Volume	6	Channel List	28
Installation.....	6	Active Antenna	28
LCD Screen.....	6	Scan Encrypted (**)	28
Overview of the Remote Control	7	Receiver Upgrade	28
LCD TV and Operating Buttons.....	8	Over Air Download (OAD)	28
Viewing the Connections- Back Connectors	9	Parental Control	28
Aerial Connection	12	Maturity Lock (**)	29
Using the Cable Holder	12	Menu Lock	29
USB Memory Connection	13	Set PIN.....	29
Side HDMI Connection.....	13	Time Settings (optional).....	29
Inserting Batteries in the Remote Control Handset...	19	Audio Description.....	29
Operating Range for the Remote Control.....	19	Audio Description	29
Switching the TV On/Off.....	19	Preferred Language	29
To Switch the TV On.....	19	Relative Volume	29
The TV will then switch on.....	19	Standby Search (optional) (*)	30
To Switch the TV Off.....	19	Language.....	30
Basic Operations	20	Preferred.....	30
Operation with the Buttons on the TV.....	20	Current.....	30
Volume Setting.....	20	Language Settings	30
Programme Selection	20	Installation.....	30
Viewing Main Menu.....	20	Automatic Channel Scan.....	31
AV Mode	20	Manual Channel Scan	31
Operation with the Remote Control	20	Clear Service List (*).....	31
Volume Setting.....	20	First Time Installation.....	31
Programme Selection (Previous or Next Prog-		Media Browser.....	32
ramme)	20	Playing MP3 Files.....	33
Programme Selection (Direct Access).....	20	Viewing JPG Files.....	33
General Operation.....	22	Slideshow Options.....	33
Information Banner	22	Video Playback.....	34
Electronic Programme Guide (EPG)	22	Navigating the Analogue TV Menu System	34
Displaying Subtitles	23	Analogue TV Menu System.....	34
Digital Teletext (** for UK only)	23	Picture Menu.....	34
Analogue Teletext.....	23	Mode.....	34
Widescreen.....	23	Brightness/Contrast/Colour/Sharpness/Hue.....	34
Channel List.....	24	Colour Temp.....	34
Navigating the Entire Channel List	24	Noise Reduction	35
Moving the channels in the channel list.....	24	Film Mode.....	35

Game Mode	35	PC Mode Menu System.....	40
Picture Zoom	35	PC Position Menu	40
Reset	35	Autoposition	40
Store	35	H (Horizontal) Position	40
Sound Menu	35	V (Vertical) Position	40
Volume	35	Phase	40
Equalizer	35	Dot Clock	40
Balance	36	PC Picture Menu.....	40
Headphone	36	Sound Menu	41
Volume	36	Feature Menu	41
Store	36	Source Menu	41
Sound Mode	36	Displaying TV Information	41
AVL	36	Mute Function	41
Effect	36	PIP (Picture-in-Picture) Mode	41
Store	36	Picture Mode Selection	41
Feature Menu	36	Freezing Picture	41
Pip-Pap	37	Zoom Modes	41
Pip Size	37	Auto	41
PIP Position	37	16:9	42
Source	37	4:3	42
Program	37	Panoramic	42
Swap	37	14:9	42
Sleep Timer	37	Cinema	42
Child Lock	37	Subtitle	42
Language	37	Zoom	42
Default Zoom	37	Teletext	42
Blue Background	37	Tips	43
Menu Background	37	Screen Care	43
Power Save Mode	37	Image Persistence	43
Backlight	37	No Power	43
Menu Timeout	37	Poor Picture	43
Teletext Language	38	No Picture	43
HDMI PC Full Mode	38	Sound	43
Full Mode (optional)	38	Remote Control	43
Ext Out	38	Input Sources	43
Install Menu	38	Appendix A: PC Input Typical Display Modes	44
Program	38	Appendix B: Supported DVI Resolutions	45
Band	38	Appendix C: AV and HDMI Signal Compatibility	
Channel	38	(Input Signal Types)	46
Colour System	38	Appendix D: Pin Specifications	47
Sound System	38	SCART connector pin specifications	47
Fine Tune	38	HDMI connector pin specifications	47
Search	38	Signal Input	47
Store	38	PC RGB Terminal (D-sub 15-pin connector)	47
Install Menu in AV Modes	38	S-input connector pin specifications	47
Colour System	39	Appendix E: PIP/PAP Mode Combinations	48
Store	39	Specifications	50
Program Table	39	DVB-T functionality information	51
Name	39	Environmental Information	51
Move	39	Product Guarantee	52
Delete	39		
APS (Auto Programming System)	39		
Country	39		
Source Menu	39		

Features

- Remote controlled colour LCD TV.
- Fully integrated digital TV (DVB-T).
- HDMI connectors for digital video and audio. This connection is also designed to accept high definition signals.
- USB input.
- 200 programmes from VHF, UHF(analogue).
- 300 programmes for digital mode (IDTV).
- OSD menu system.
- Two scart sockets for external devices (such as video, video games, audio set, etc.).
- Stereo sound system. (German+Nicam)
- Teletext, fastext, TOP text.
- Headphone connection.
- Automatic programming system.
- Forward or backward manual tuning.
- Sleep timer.
- Child lock.
- Automatic sound mute when no transmission.
- NTSC playback.
- PIP / PAP / PAT functions.
- AVL (Automatic Volume Limiting).
- When no valid signal is detected, after 5 minutes the TV switches itself automatically to standby mode.
- PLL (Frequency Search).
- PC input.
- Plug&Play for Windows 98, ME, 2000, XP, Vista, Windows 7.
- Audio line out.
- Game Mode
- Active antenna power.

Accessories

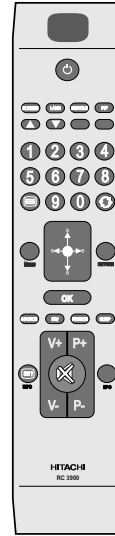

Remote Controller

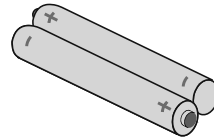

Batteries
2 X AAA

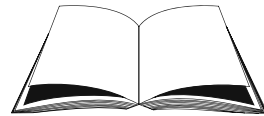

Instruction Book

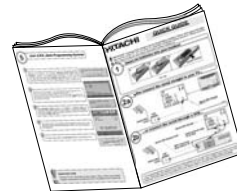

Quick Guide



Cable Holder

Introduction

Thank you for choosing this product. This manual will guide you for the proper operation of your TV. Before operating the TV, please read this manual thoroughly.



Please do keep this manual in a safe place for future references.

Preparation

For ventilation, leave a free space of at least 10 cm all around the set. To prevent any fault and unsafe situations, please do not place any objects on top of the set.

Use this device in moderate climates.

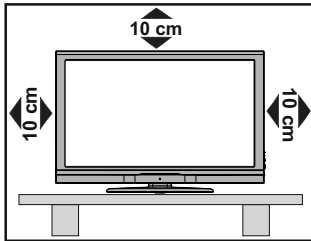

Safety Precautions

Please read the following recommended safety precautions carefully for your safety.

SOME DOS AND DON'TS ON THE SAFE USE OF EQUIPMENT

This equipment has been designed and manufactured to meet international safety standards but, like any electrical equipment, care must be taken if you are to obtain the best results and safety is to be assured.

DO read the operating instructions before you attempt to use the equipment.

DO ensure that all electrical connections (including the mains plug, extension leads and inter-connections between the pieces of equipment) are properly made and in accordance with the manufacturer's instructions. Switch off and withdraw the mains plug before making or changing connections.

DO consult your dealer if you are ever in doubt about the installation, operation or safety of your equipment.

DO be careful with glass panels or doors on equipment.

DO route the mains lead so that it is not likely to be walked on, crushed, chafed, or subjected to excessive wear and tear or heat.

DON'T remove any fixed cover as this may expose dangerous voltages.

DON'T obstruct the ventilation openings of the equipment with items such as newspapers, tablecloths, curtains, etc. Overheating will cause damage and shorten the life of the equipment.

DON'T allow electrical equipment to be exposed to dripping or splashing, or objects filled with liquids, such as vases, to be placed on the equipment.

DON'T place hot objects or naked flame sources such as lighted candles or nightlights on, or close to equipment. High temperatures can melt plastic and lead to fires.

DON'T use makeshift stands and **NEVER** fix legs with wood screws - to ensure

complete safety always fit the manufacturer's approved stand or legs with the fixings provided according to the instructions.

DON'T use equipment such as personal stereos or radios so that you are distracted from

the requirements of traffic safety. It is illegal to watch television whilst driving.

DON'T listen to headphones at high volume, as such use can permanently damage your hearing.

DON'T leave equipment switched on when it is unattended unless it is specifically stated

that it is designed for unattended operation or has a stand-by mode. Switch off using the

switch on the equipment and make sure that your family know how to do this. Special

arrangements may need to be made for infirm or handicapped people.

DON'T continue to operate the equipment if you are in any doubt about it working

normally, or if it is damaged in any way - switch off, withdraw the mains plug and consult

your dealer.

ABOVE ALL

--- NEVER let anyone especially children push anything into holes, slots or any other opening in the case - this could result in a fatal electrical shock;

--- NEVER guess or take chances with electrical equipment of any kind

--- it is better to be safe than sorry!



Power Source

The TV set should be operated only from a 220-240 V AC, 50 Hz outlet.

Power Cord

Do not place the set, a piece of furniture, etc. on the power cord (mains lead) or pinch the cord. Handle the power cord by the plug. Do not unplug the appliance by pulling from the power cord and never touch the power cord with wet hands as this could cause a short circuit or electric shock. Never make a knot in the cord or tie it with other cords. The power cords should be placed in such a way that they are not likely to be stepped on. A damaged power cord can cause fire or give you an electric shock. When it is damaged and needs to be replaced, it should be done by qualified personnel.

This TV receiver is supplied with a moulded mains plug. The mains plug must not be cut off, as it may contain a special radio interference filter, the removal of which could lead to impaired performance. If you wish to extend the lead, obtain an appropriate safety approved extension lead or consult your dealer.

Observe the manufacturers instructions when connecting extension leads to the set. Check the fuse rating on the new plug; this should be fitted with a 5 Amp fuse which conforms to either ASTA or BSI (BS1362) approvals, these are easily identifiable by either the  or  symbols. If you are in any doubt about the installation of an extension lead, please consult a competent electrician.

Warning

Do not leave your TV in standby or operating mode when you leave your house.

Disconnecting the Device

The mains plug is used to disconnect TV set from the mains and therefore it must remain readily operable.

Moisture and Water

Do not use this device in a humid and damp place (avoid the bathroom, the sink in the kitchen, and near the washing machine). Do not expose this device to rain or water, as this may be dangerous and do not place objects filled with liquids, such as vases, on top. Avoid dripping or splashing.

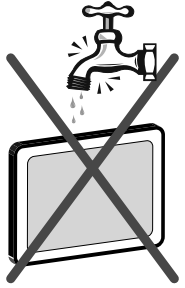

If any solid object or liquid falls into the cabinet, unplug the TV and have it checked by qualified personnel before operating it any further.

Cleaning

Before cleaning, unplug the TV set from the wall outlet. Do not use liquid or aerosol cleaners. Use soft and dry cloth.

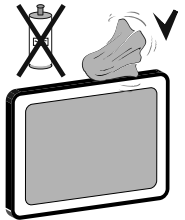

Ventilation

The slots and openings on the TV set are intended for ventilation and to ensure reliable operation. To prevent overheating, these openings must not be blocked or covered in anyway.

Heat and Flames

The set should not be placed near to open flames and sources of intense heat such as an electric heater. Ensure that no open flame sources, such as lighted candles, are placed on top of the TV.

Batteries should not be exposed to excessive heat such as sunshine, fire or the like.



Lightning

In case of storm and lightning or when going on holiday, disconnect the power cord from the wall outlet.

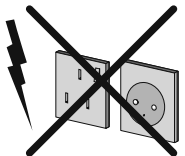

Replacement Parts

When replacement parts are required, make sure that the service technician has used replacement parts, which are specified by the manufacturer or have the same specifications as the original one. Unauthorized substitutions may result in fire, electrical shock or other hazards.

Servicing

Please refer all servicing to qualified personnel. Do not remove the cover yourself as this may result in an electric shock.

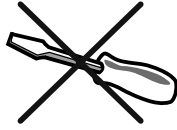

Waste Disposal

Instructions for waste disposal:

- Packaging and packaging aids are recyclable and should principally be recycled. Packaging materials, such as foil bag, must be kept away from children.
- Batteries, including those which are heavy metal-free, should not be disposed of with household waste. Please dispose of used battery in an environmentally friendly manner. Find out about the legal regulations which apply in your area.
- Cold cathode fluorescent lamp in LCD PANEL contains a small amount of mercury; please follow the local laws or regulations for disposal.

Information for Users in European Union Countries

The mark  is in compliance with the Waste Electrical and Electronic Equipment Directive 2002/96/EC (WEEE).

The mark indicates the requirement NOT to dispose the equipment including any spent or discarded batteries as unsorted municipal waste, but use the return and collection systems available. If the batteries or accumulators included with this equipment, display the chemical symbol Hg, Cd, or Pb, then it means that the battery has a heavy metal content of more than 0.0005% Mercury,



or more than 0.002% Cadmium or more than, 0.004% Lead.

Headphone Volume

Excessive sound pressure from earphones and headphones can cause hearing loss.



Installation

To prevent injury, this device must be securely attached to the wall in accordance with the installation instructions when mounted to the wall (if the option is available).

LCD Screen

The LCD panel is a very high technology product with about a million thin film transistors, giving you fine picture details. Occasionally, a few non-active pixels may appear on the screen as a fixed blue, green or red point. Please note that this does not affect the performance of your product.

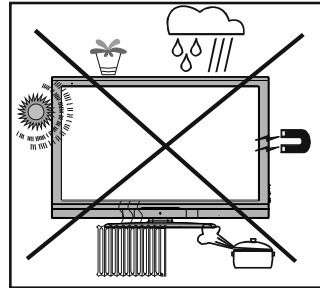

Overview of the Remote Control

1. Standby
2. Mono/Stereo - Dual I-II / Current Language (*) (in DTV mode)
3. Expand (in TXT mode)/ Image size
4. Green / Picture Menu / Subtitle on-off (*) (in DTV mode)
5. Red /Sound Menu / Channel List (*) (in DTV mode)
6. Numeric buttons
7. Teletext / Mix / PAT Mode (in TXT mode)
8. Cursor Left
9. Menu
10. AV / Source
11. Favourite Mode Selection (*) (in DTV mode)
12. Volume Up
13. Info / Reveal (in TXT mode)
14. Mute
15. Volume Down
16. Programme Down / Page up (in DTV mode)
17. Electronic programme guide (in DTV mode)
18. Programme Up / Page down (in DTV mode)
19. Sleep Timer
20. Picture Mode Selection
21. Okay (Store) / Select / Hold (in TXT mode)
22. Cursor Down
23. Exit (in DTV mode) / Return / Index page (in TXT mode)
24. Cursor Right / Subpage (in TXT mode)
25. Cursor Up
26. Previous programme
27. Yellow / Feature Menu / Current Language (*) (in DTV mode)
28. Blue / Install Menu / Favourite Mode Selection (*) (in DTV mode)
29. No function
30. Subtitle on-off (in DTV mode) / TXT subtitle

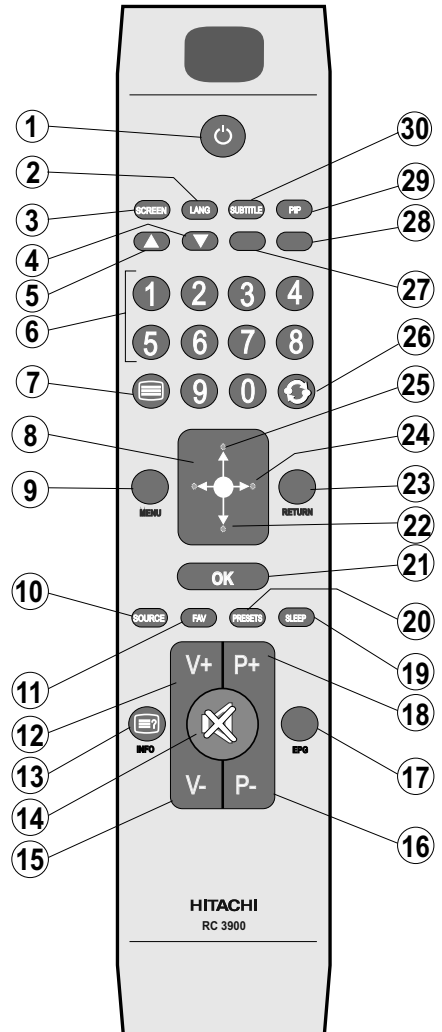



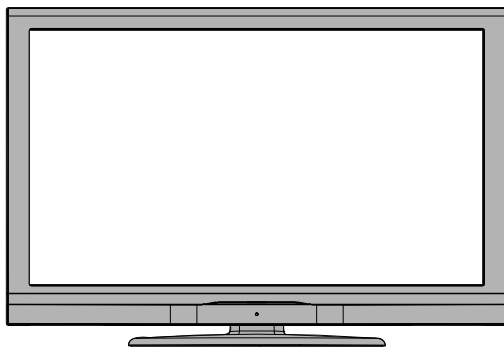

LCD TV and Operating Buttons

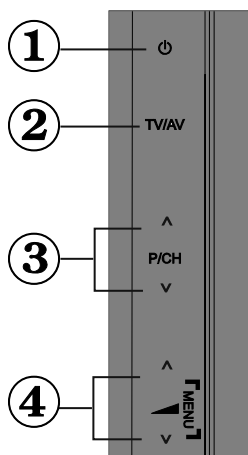

FRONT VIEW



1. Standby button
2. TV/AV button
3. Programme Up/Down buttons
4. Volume Up/Down buttons

Note: Press “ ” / “ ” buttons at the same time to view main menu.

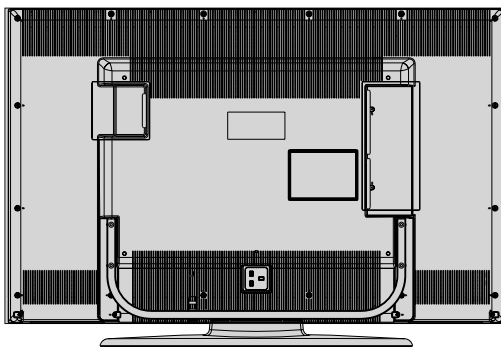
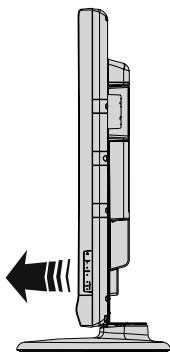

REAR VIEW

Viewing the Connections- Back Connectors

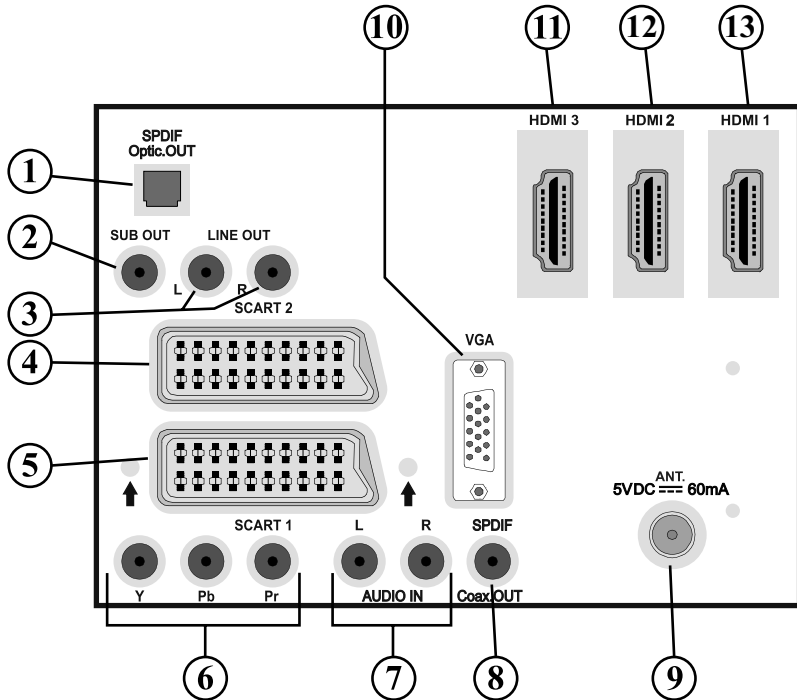

- 1. S/PDIF Digital Out** outputs digital audio signals of the currently watched source. Use a digital optic cable to transfer audio signals to a device that has S/PDIF input.
- 2. Subwoofer Out** is for connecting an external, active subwoofer to the set to give a much deeper bass effect. Use an appropriate RCA cable to connect the set to a subwoofer unit.
- 3. Audio Line Outs** output audio signals to an external device such as an optional sound system. To connect the external speakers to your TV, use **AUDIO LINE OUTS** of the TV with an audio cable.
- 4. SCART 2** inputs or outputs for external devices.
- 5. SCART 1** inputs or outputs for external devices. Connect the **SCART** cable between **SCART** sockets on TV and **SCART** socket on your external device (such as a decoder, a VCR or a DVD player).
Note: If an external device is connected via the **SCART** sockets, the TV will automatically switch to AV mode. If both sockets are employed at the same time, **SCART 1** will override **SCART 2** unless manually selected.
Note: You should connect the decoder to EXT-1, if you are planning to watch a scrambled channel. The decoder might not function properly if you do not connect the decoder to the Scart 1 (Ext-1) socket.
Note: Picture state can be affected by scart cable quality.
- 6. Component Video Inputs (YPbPr)** are used for connecting component video. You can connect the component video and audio sockets with a device that has component output. Connect the component video cables between the **COMPONENT VIDEO INPUTS** on on the TV and the component video outputs of your device. While connecting, be sure

that the letters on your TV, “**Y**”, “**Pb**”, “**Pr**” correspond with your device’s connectors.

7. **PC/YPbPr Audio Inputs** are used for connecting audio signals of a PC or a device that connects to the TV via YPbPr.
Connect the PC audio cable between the **AUDIO INPUTS** on the TV and audio output of your PC to enable PC audio.
Connect the audio cable between **AUDIO INPUTS** on the TV and audio outputs of your device to enable component audio.
8. **S/PDIF Coaxial Out** outputs digital audio signals of the currently watched source.
Use an **SPDIF coaxial cable** to transfer audio signals to a device that has S/PDIF input.
9. **RF Input** connects to an antenna or a cable.
Note that if you use a decoder or a media recorder, you should connect the aerial cable through the device to the television with an appropriate antenna cable, as shown in the illustration in the following pages.
10. **PC Input** is for connecting a personal computer to the TV set.
Connect the PC cable between the **PC INPUT** on the TV and the PC output on your PC.
11. **HDMI 3:** HDMI Input
12. **HDMI 2:** HDMI Input
13. **HDMI 1:** HDMI Input

HDMI Inputs are for connecting a device that has an **HDMI** socket. Your LCD Television is capable of displaying High Definition pictures from devices such as a High Definition Satellite Receiver or DVD Player. These devices must be connected via the HDMI sockets or Component Socket. No sound connection is needed for an HDMI to HDMI connection.

Viewing the Connections - Side Connectors

1. CI Slot is used for inserting a CI card. A CI card allows you to view all the channels that you subscribe to. For more information, see “Conditional Access” section.
2. Side USB input.
Note: *Codec update cannot be performed.*
3. Side HDMI Input is for connecting a device that has an HDMI socket.
4. Headphone jack is used for connecting an external headphone to the system. Connect to the HEADPHONE jack to listen to the TV from headphones.
5. Video Input is used for connecting video signals of external devices. Connect the video cable between the VIDEO IN socket on the TV and the VIDEO OUT jack on your device.
6. Audio Inputs are used for connecting audio signals of external devices. Connect the audio cable between the AUDIO INPUTS on the TV and the AUDIO OUTPUT jacks on your device.
Note: If you connect a device to the TV via the VIDEO INPUT, you should also connect your device with an audio cable to the AUDIO INPUTS of the TV to enable audio.
7. S-Video Input is used for connecting an S-Video signal (e.g. from a camcorder or VCR). For using S-VIDEO input; connect the video cable between the S-VIDEO input on the TV and the S-Video output on your device. Connect the audio cable between the AUDIO INPUTS (indicated with letter C in the illustration) on the TV and the audio jacks on your device.
8. Standby switch is used for turning the TV on or off.

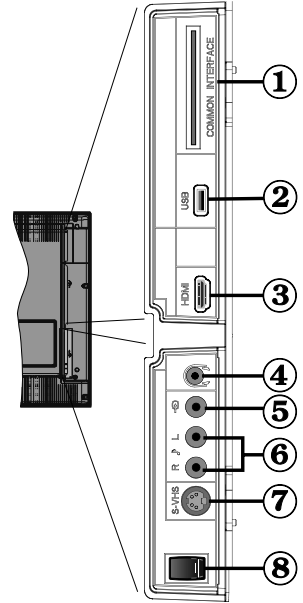

Power Connection

IMPORTANT: The TV set is designed to operate on 220-240V AC, 50 Hz.

- After unpacking, allow the TV set to reach the ambient room temperature before you connect the set to the mains.
- Plug the power cable to the mains socket outlet.

Aerial Connection

- Connect the aerial or cable TV plug to the AERIAL INPUT socket located at the rear of the TV.

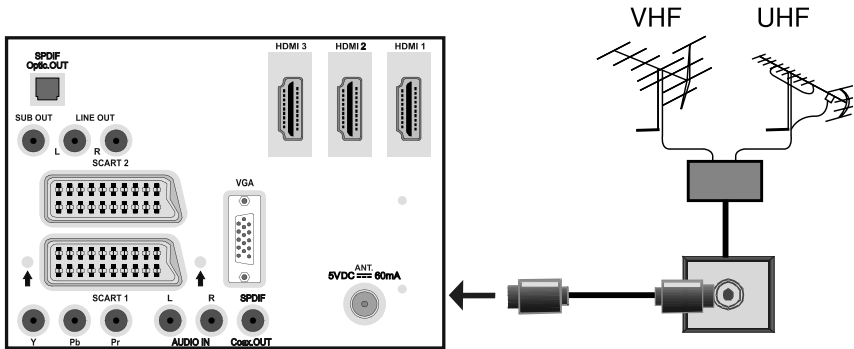

REAR VIEW

Using the Cable Holder

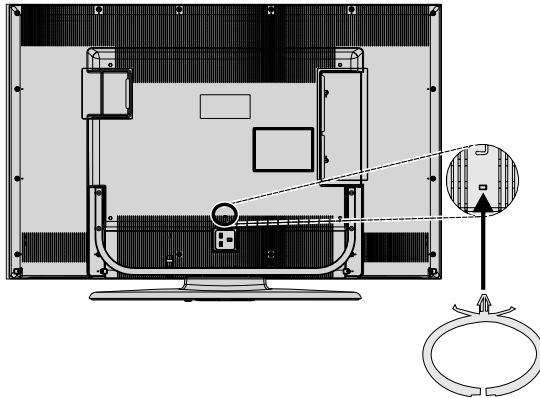

You can use the supplied cable holder as the following:

- Place the cable holder into the cable holder hole located on the rear side of the TV as illustrated above.
- Place cables into the cable holder after all necessary connections are made.

Using Digital Multimedia Connectors

- You can connect USB devices to your TV by using the USB input of the TV. This feature allows you to display/play JPG and MP3 files stored in a USB stick.
- It is possible that certain types of USB devices (e.g. MP3 Players) may not be compatible with this TV.
- You may back up your files before making any connections to the TV set in order to avoid any possible data loss. Note that manufacturer will not be responsible for any file damage or data loss.
- Do not pull out USB module while playing a file.

CAUTION: Quickly plugging and unplugging USB devices, is a very hazardous operation. Especially, do not repeatedly quickly plug and unplug the drive. This may cause physical damage to the USB player and especially the USB device itself.

SIDE VIEW USB MEMORY

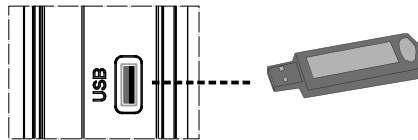

USB Memory Connection

- Plug your USB device to the USB input of the TV.

Note: USB hard disk drives are not supported.

- If the plugged USB disk is not recognised, please reinsert the disk.
- It is recommended that you connect your USB device directly to the USB input of the TV. Some compatibility problems may occur if you use a separate cable connection.



Side HDMI Connection

You can use side HDMI input to connect a device that has an HDMI connector to your TV. Use an appropriate HDMI cable to make such a connection. Note that you should switch to HDMI-4 source to view the content from the connected device. Power off both the TV and the device before making any connections.

- Side HDMI Input supports connections between HDMI devices such as DVD players. You can use side HDMI input of the TV to connect to an external HDMI device. Use an HDMI cable to connect.

HDMI DEVICE SIDE VIEW

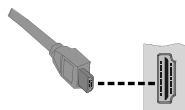

Connecting the LCD TV to a PC

For displaying your computer's screen image on your LCD TV, you can connect your computer to the TV set.

- Power off both computer and display before making any connections.
- Use 15-pin D-sub display cable to connect a PC to the LCD TV.
- When the connection is made, switch to PC source. See "Input selection" section.
- Set the resolution that suits your viewing requirements. Resolution information can be found in the appendix parts.

REAR VIEW

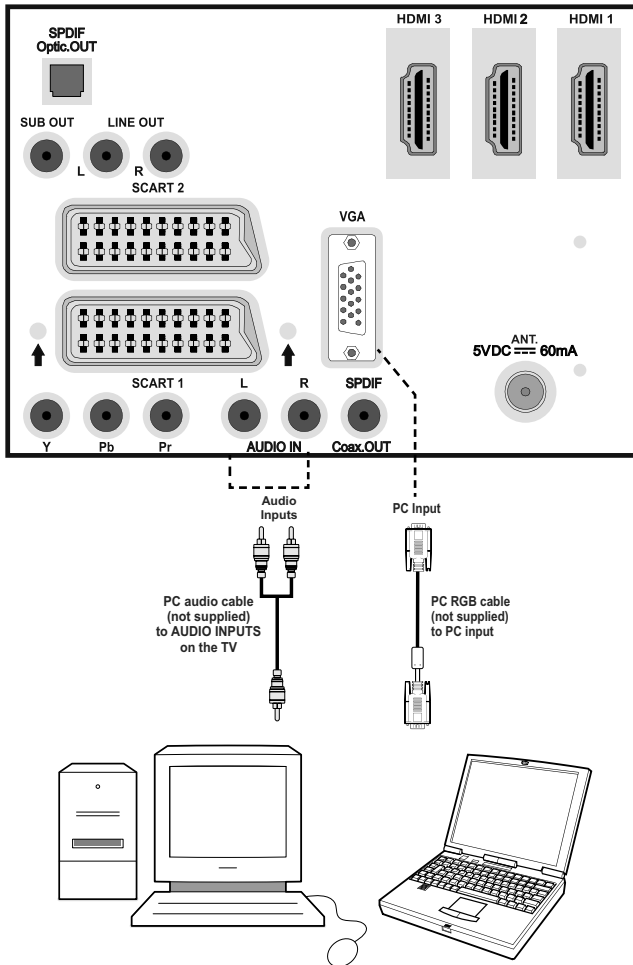

Connecting to a DVD Player

If you want to connect a DVD player to your LCD TV, you can use connectors of the TV set. DVD players may have different connectors. Please refer to your DVD player's instruction book for additional information. Power off both the TV and the device before making any connections.

Note: Cables shown in the illustration are not supplied.

- If your DVD player has an HDMI socket, you can connect via HDMI. When you connect to DVD player as illustrated below, switch to HDMI source. See, "Input Selection" section.
- Most DVD players are connected through COMPONENT SOCKETS. Use a component video cable to connect video input. For enabling audio, use a component audio cable as illustrated below. When the connection is made, switch to YPbPr source. See, "Input selection" section.
- You may also connect through the SCART 1 or SCART 2. Use a SCART cable as shown below.

Note: These three methods of connection perform the same function but in different levels of quality. It is not necessary to connect by all three methods.

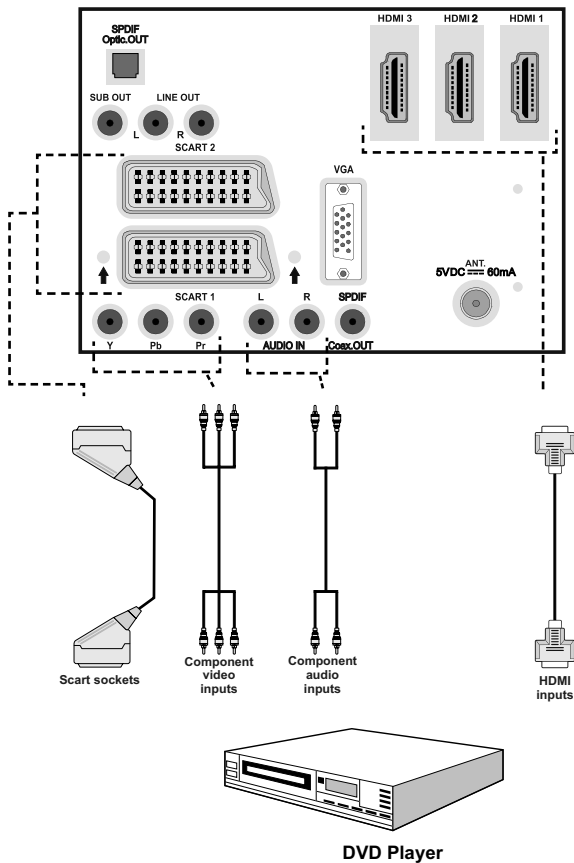

REAR VIEW

Using Side AV Connectors

You can connect a range of optional equipment to your LCD TV. Possible connections are shown below. Note that cables shown in the illustration are not supplied.

- For connecting a camcorder, connect to the S-VIDEO or VIDEO IN socket and the AUDIO SOCKETS. Do not connect the camcorder to S-VIDEO and VIDEO IN socket at the same time since it can cause noise in the picture. For selecting the related source, see the section “Input selection” in the following parts.
- To listen the TV sound from headphones, connect to the HEADPHONE jack of the TV.

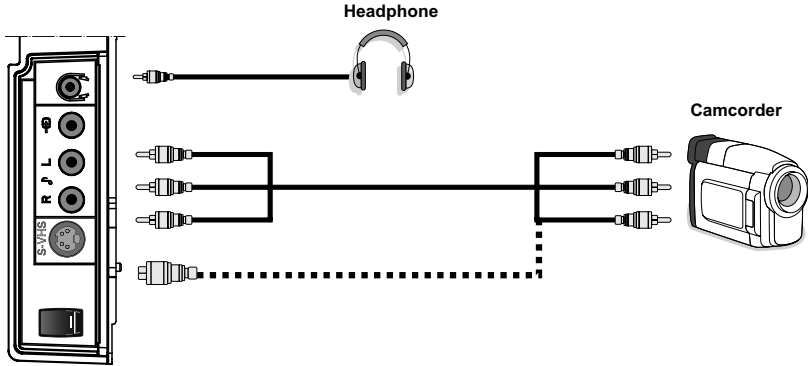

SIDE VIEW

Using Other Connectors

You can connect a range of optional equipment to your LCD TV. Possible connections are shown below. Note that cables shown in the illustration are not supplied.

- To connect external speakers, use an audio cable. Do not reverse the AUDIO LEFT and AUDIO RIGHT jacks. Turn on the LCD TV and external speaker set after all connections are made. Refer to your speaker set's manual for further queries.
- For connecting a to a device that has SPDIF support, use an appropriate SPDIF cable to enable sound connection.

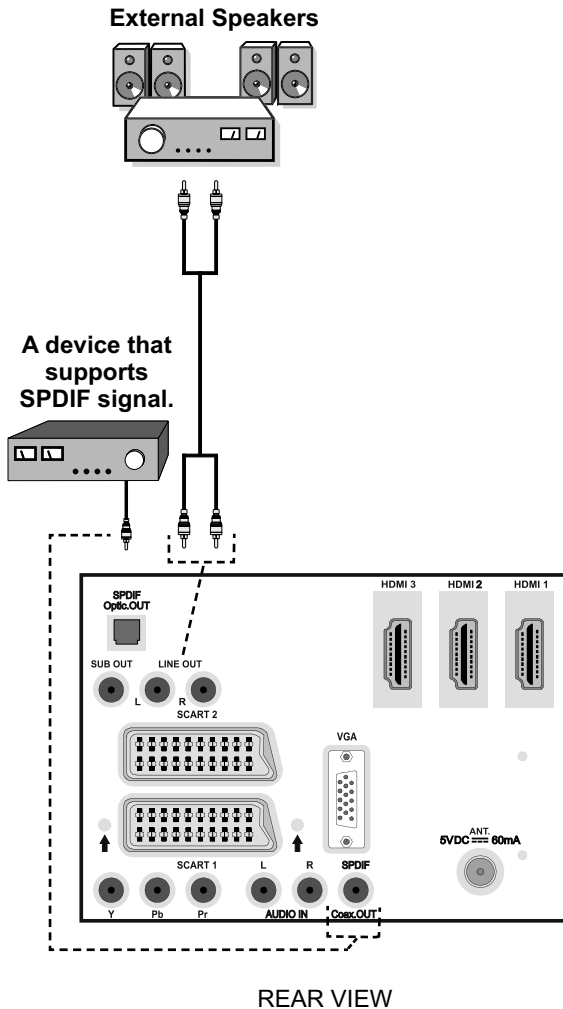

Connecting Other Equipment via Scart

Most devices support SCART connection. You can connect a DVD recorder, a VCR or a decoder to your LCD TV by using the SCART sockets. Note that cables shown in the illustration are not supplied.

Power off both the TV and the devices before making any connections.

For more information, refer to your device's own instruction book.

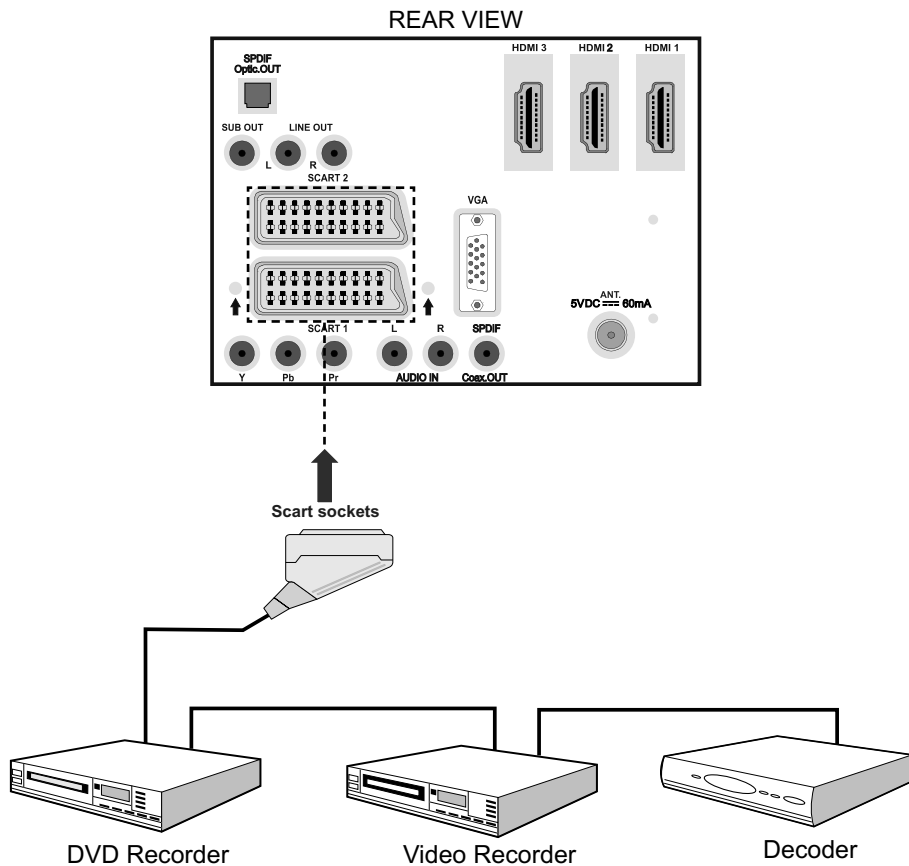

Inserting Batteries in the Remote Control Handset

- Remove the battery cover located on the back of the handset by gently pulling backwards from the indicated part.
- Insert two **AAA/R3** or equivalent type batteries inside. Place the batteries in the right directions and replace the battery cover.

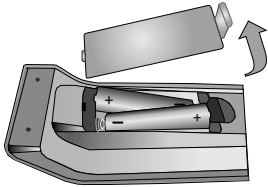

Note: Remove the battery from remote control handset when it is not to be used for a long period. Otherwise it can be damaged due to any leakage of batteries.

Operating Range for the Remote Control

- Point the top of the remote control toward the LCD TV's remote sensor LED while pressing a button.

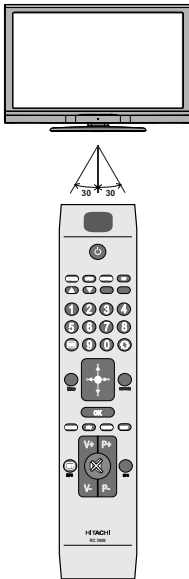

Remote range is approximately 7m/23ft.

Switching the TV On/Off

To Switch the TV On

- Connect the power cord to the 220-240V AC 50 Hz.
- Switch the “**I**” button to position “**I**” so the TV will switch to standby mode. Then the standby LED lights up.
- To switch on the TV from standby mode either:
 - Press the “**⏻**” button, **P+** / **P-** or a numeric button on the remote control.
 - Press the **-P/CH** or **P/CH+** button on the TV.

The TV will then switch on.

Note: If you switch on your TV via **PROGRAMME UP/DOWN** buttons on the remote control or on the TV set, the programme that you were watching last will be reselected.

By either method the TV will switch on.

To Switch the TV Off

- Switch the “**I**” button to position 2 as illustrated, (②) so the TV will switch **OFF**.
- **To power down the TV completely, unplug the power cord from the mains socket.**

Note: When the TV is switched to standby mode, standby LED can blink to indicate that features such as Standby Search, Over Air Download or Timer is active.

Input Selection

Once you have connected external systems to your TV, you can switch to different input sources.

- Press **"SOURCE"** button on your remote control for directly changing sources.

or,

- Select **"Source"** option from the main menu by using **"◀"** or **"▶"** button. Use then **"▼"** or **"▲"** button to highlight an input and press **"▶"** button to select.

Note: You can mark desired source options by pressing the **OK** button. Therefore, when **"SOURCE"** button is pressed, only the marked source options will be available (except for the TV source).



Basic Operations

You can operate your TV using both the remote control and onset buttons.

Operation with the Buttons on the TV

Volume Setting

- Press **"- ▾"** button to decrease volume or **"▴ +"** button to increase volume, so a volume level scale (slider) will be displayed on the screen.

Programme Selection

- Press **"P/CH +"** button to select the next programme or **"P/CH -"** button to select the previous programme.

Viewing Main Menu

- Press **"- ▾"** / **"▴ +"** buttons at the same time to view main menu. In the Main menu select sub-menu using **"P/CH -"** or **"P/CH +"** buttons and enter the sub-menu using **"- ▾"** or **"▴ +"** buttons. To learn the usage of the menus, refer to the menu system sections.

AV Mode

- Press the **"TV/AV"** button in the control panel on the TV to switch between AV modes.

Operation with the Remote Control

- The remote control of your TV is designed to control all the functions of the model you selected. The functions will be described in accordance with the menu system of your TV.
- Functions of the menu system are described in the following sections.

Volume Setting

- Press **"V+"** button to increase the volume. Press **"V-"** button to decrease the volume. A volume level scale (slider) will be displayed on the screen.

Programme Selection (Previous or Next Programme)

- Press **"P -"** button to select the previous programme.
- Press **"P +"** button to select the next programme.

Programme Selection (Direct Access)

- Press numeric buttons on the remote control to select programmes between 0 and 9. The TV will switch to the selected programme. To select programmes between 10 - 299 (for IDTV) or 10-199 (for analogue), press the numeric buttons consecutively (e.g. for programme 27, first press 2 and then 7). When the pressing time is due for the second numeric button, only the first digit programme will be displayed. The limit of the delay time is 3 seconds.
- Press directly the programme number to reselect single digit programmes.

Initial Settings

When the TV set is operated for the first time, the IDTV turns on first.

Because this is the first time the TV is used, there are no channels stored in the memory.

When the TV is turned on for the first time, the menu for the language selection appears on the screen. The message "Welcome please select your language!" is displayed in all language options sequentially in the OSD.

By pressing the "▼" or "▲" buttons highlight the language you want to set and press OK button and then, "First time installation" OSD will appear on the screen.

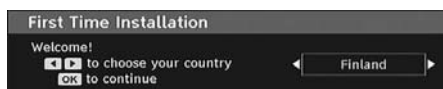

By pressing "◀" or "▶" buttons, select the country you want to set and press OK button. (** for EU countries).

Note: Country selection OSD will not be available for UK.

After then, the active antenna selection OSD appears on the screen:

By pressing "◀" or "▶" buttons, set active antenna mode as on or off.



If an active antenna is connected to your TV, you can select this option as On. Antenna power should be "Off" when standard antenna is used instead of the active antenna. See Configuration Menu in the following sections for more information.

Press OK button on the remote control to continue and the following message will be displayed on the screen:

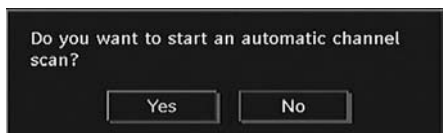

To start installation process, select "Yes", to cancel select "No".

- To select the "Yes" or "No" option, highlight the item by using "◀" or "▶" buttons and press the OK button.

The IDTV will automatically tune to the UHF or VHF (**For EU countries except UK) transmission channels, searching for digital terrestrial TV broadcasts and displaying the names of channels found. This process will take about a few minutes. To cancel searching, you can press the "MENU" button at any time during the process.



After Automatic Search is completed, the following message asking for analogue channel search appears on the screen:

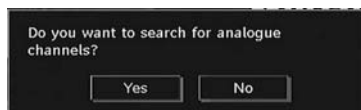

To search for analogue channels, select "Yes". TV switches to the analogue TV mode. The menu below is displayed to search for analogue channels:



Select your Country, Language and Text language by using "◀" or "▶" and "▼" or "▲" buttons. Press OK or RED button to continue. To cancel, press the BLUE button.

For more information on this process, see “Install Menu” section.

Note: For proper functioning of digital teletext in DTV mode, you should set country as UK in analogue AUTO PROGRAM (for UK only).

General Operation

Press the “SOURCE” button and select DTV/USB from the list. The TV then switches to digital TV mode.

Information Banner

- Whenever you change channel, using the P- / P+ button or the numeric buttons, the TV displays the broadcast picture along with an information banner at the bottom of the screen (available only in DTV mode). This will remain on the screen for a few seconds.
- The information banner can also be displayed at any time while watching TV by pressing the INFO button on the remote control:



The information banner gives information on the channel selected and the programmes on it. The name of the channel is displayed, along with its channel list number.

Hint: Not all channels broadcast the programme data. If the name and time of the programme are not available, then information banner will be displayed with blanks.

- Icons are also displayed in the information banner and if this channel is a favourite channel, favourite channel icon will also be displayed.

If the selected channel is locked, you must enter the correct four numeric code to view the channel. “Enter PIN” will be displayed on the screen in such a case:

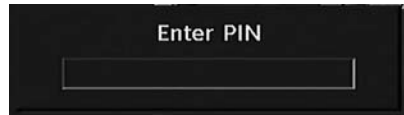

Electronic Programme Guide (EPG)

- Some, but not all, channels send information about the current and next events.
- Please note that event information is updated automatically. If there is no event information data available in channels, EPG will be displayed with blanks.
- Press **EPG** button to view the EPG menu.
- Electronic Programme Guide appears on the screen. It is able to get Information of the channel - programs weekly by means of 7-DAY-EPG. All programs of channels are displayed. The current program is highlighted and there is brief information about the programs of the channel, such as: name, short/extended event description, start & end time. The time scale can be changed by pressing left or right buttons. If there is any event information data available, only programme names and dates are displayed. On the bottom of the screen; info bar, showing all the available commands, will be displayed.



RED button (Shrink): makes the info boxes smaller.

GREEN button (Expand): makes the info boxes larger.

YELLOW button (Prev. Day): displays the programmes of previous day.

BLUE button (Next day): displays the programmes of the next day.

INFO (Details): displays the programmes in detail.

Numeric buttons (Jump): go to preferred channel directly via numeric buttons.

OK : views options for future programmes.

 : jumps to the current broadcast.

- Press “**0**” button to view Guide Search menu. Using this feature, you can search the programme guide database in accordance with the genre selected or with name match. Info available in the programme guide will be searched and results matching your criteria will be listed. You can select programmes or set timers by highlighting a channel and then pressing **OK** button.

Note: Searching process can be performed by the desired date rate or by the channel basis.

Displaying Subtitles

With digital terrestrial broadcasting (DVB-T), some programmes are broadcast with subtitles. Subtitles can be displayed while watching these programmes.

Note: You can enable subtitles by pressing the “**SUBTITLE**” button.

Press the “**MENU**” button to display the main menu, highlight the **Setup** and then **Language** menu using “**▼**” or “**▲**” button and press the **OK** button to display the “Language settings” menu.

Highlight the “Subtitle” item in “Language settings” menu and use **◀** or **▶** button to set Subtitle to the desired language.

If “Subtitle” is on and a language option is set, pressing the **TELETEXT** () button causes the following warning message display on the screen (* for UK only):



Digital Teletext (** for UK only)

With digital terrestrial broadcasting (DVB-T), in addition to pictures and sound, you can also view digital teletext.



Digital teletext is sometimes broadcast at the same time with the normal broadcasting.

- Press the **TELETEXT** () button.

- The digital teletext information appears.
- Operate it with the coloured buttons, cursor buttons and **OK** button.

The operation method may differ depending on the contents of the digital teletext.

Follow the instructions displayed on digital teletext screen.

- When Press “**OK**” button or similar message appears on the screen, press the **OK** button.
- When the **TELETEXT** () button is pressed, the TV returns to television broadcasting.
- With digital terrestrial broadcasting (DVB-T), in addition to digital teletext broadcasting together with the normal broadcasting, there are also channels with just digital teletext broadcasting.
- The aspect ratio (picture shape) when watching a channel with just digital teletext broadcasting is the same as the aspect ratio of the picture viewed previously.
- When you press the **TELETEXT** () button again, the digital teletext screen will be displayed.

Analogue Teletext

Use of teletext and its functions are identical to the analogue text system. Please do refer to the “**TELETEXT**” explanations.

Widescreen

Depending on the type of the broadcast being transmitted, programmes can be viewed in a number of formats. Press the **SCREEN** button repeatedly to select between Auto, 16:9, 4:3, Panoramic, 14:9, Cinema, Zoom or Subtitle.

When Auto is selected, the format being displayed is determined by the picture being broadcast.

***PLEASE NOTE:** Menu size changes depending on the chosen image size.*

IDTV Menu System

The IDTV menu can only be viewed when watching digital terrestrial broadcasting. Press the TV/DTV button to turn IDTV on while the TV is in analogue mode.

Press the **"MENU"** button. The menu below appears on the screen:



Channel List

Using the **"▼"** or **"▲"** button on the remote control, make sure that the first item, Channel List, is highlighted and press the OK button to display the Channel List.

The following operations can be performed in this menu:

- Navigating the entire list of channels
- Deleting channels
- Renaming channels
- Adding locks to channels
- Setting favourites
- Moving channels

Channel List is the place where the channels are managed.



Navigating the Entire Channel List

Press **"▼"** or **"▲"** button for selecting the previous or next channel. You can press **P+** or **P-** button to move page up or page down.

To watch a specific channel, highlight it using **"▼"** or **"▲"** button and then press **"OK"** button, while the **"Select"** item on Channel List menu is highlighted by using **"◀"** or **"▶"** button.

Then the name and number of the selected channel will be displayed in the top-left and top-right of the channel display at the top-right of the screen, respectively.

Moving the channels in the channel list

- Press **"▼"** or **"▲"** buttons to select the channel that will be moved.
- Press **"◀"** or **"▶"** buttons to select the **"Move"** item on Channel List menu.

Following OSD will be displayed next to **"OK"** item to indicate that enter a number by using the numeric buttons on the remote control and press **"OK"** to confirm.



Note: If you enter the same programme number of the channel that you want to move, "... channel services will be replaced. Do you want to continue?" OSD will be displayed. Press OK to confirm or select "No" to cancel.

Deleting the Channels in the Channel List

- Press **"▼"** or **"▲"** button to select the channel that will be deleted.

- Press “◀” or “▶” button to select the “Delete” item on Channel List menu. As seen on Channel List menu, **OK** is displayed next to Delete item at the bottom of the screen to indicate that you must press the **OK** button to delete the highlighted channel in the channel list.

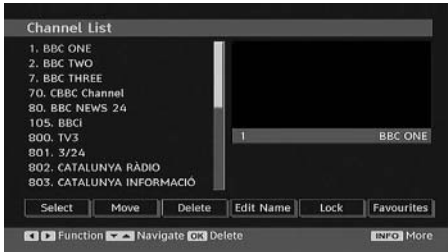

Press the **OK** button to delete the highlighted channel in the channel list. Then the message below appears on the screen:

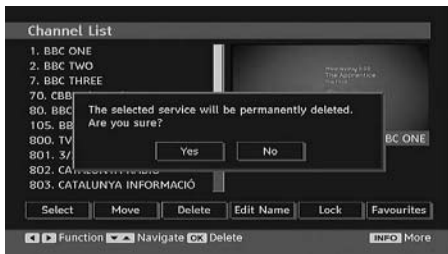

Press “◀” or “▶” button to highlight the desired option. If **OK** button is pressed while “Yes” is highlighted, the highlighted channel is deleted. Selecting “No” cancels the deletion.

Renaming Channels

To rename a specific channel, the channel must be highlighted by pressing “▼” or “▲” button. Then highlight the **Edit Name** item by pressing “◀” or “▶” button as illustrated below. Press the **OK** button to activate the rename feature.



Now pressing “◀” or “▶” button moves to the previous/next character. Pressing “▼” or “▲”

” button toggles the current character, i.e., ‘b’ character becomes ‘a’ by “▼” and ‘c’ by “▲”. Pressing the numeric buttons ‘0...9’ replaces the highlighted character with the characters printed above the button one by one as the button is pressed.

Press the “**MENU**” button to cancel the editing or **OK** button to save the new name.

Adding Locks to Channels

Channel locking provides a password-protected access to channels selected by parents. In order to lock a channel you should know the parental lock password (default value is set to 0000 in the factory and can only be changed from the Configuration menu).

Select the channel to be locked by highlighting it and select the Lock option by pressing “◀” or “▶” button. When the **OK** button is pressed, a dialog OSD asking for the password will be displayed.



Enter the password by using the numeric buttons on the remote control. The lock icon “🔒” will now be displayed next to the selected channel. Repeat the same operation to cancel the lock.

Setting Favourites

You can set various channels as favourites so that only the favourite channels are navigated. To set a favourite you should highlight the “Favourites” item at the bottom of the Channel List menu.

To set a favourite you should highlight the “Favourites” item at the bottom of the Channel List menu. Then press **OK** button and Edit Favourite List menu appears on the screen.

You can list your favourite channels using Favourite List.

Channel list OSD will look like this:

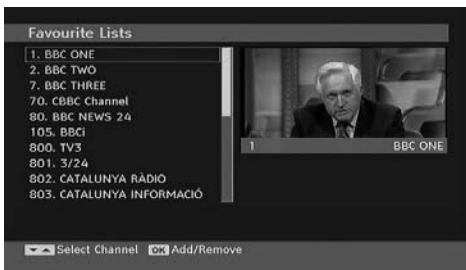

How to Add a Channel to a Favourites List

- By pressing “▼” or “▲” buttons, highlight the channel that you want to add to the favourite list.
- By pressing OK button, the highlighted channel is added to the Favourite List.
- F icon indicates that a channel is added to Favourite List.

Removing a Channel from Favourite List

- Highlight the channel that you want to remove from the favourite list and press OK button to remove. You can press OK button again to re-add a channel.
- To activate Favourites, go to the Configuration menu and select Favourite mode. Use “◀” / “▶” to set Favourite mode as on. To cancel Favourites, set Favourite Mode to Off.

On Screen Help

For all menus, press the **INFO** button to display the help information about the menu functions. For Channel List menu the following message is displayed on the screen:

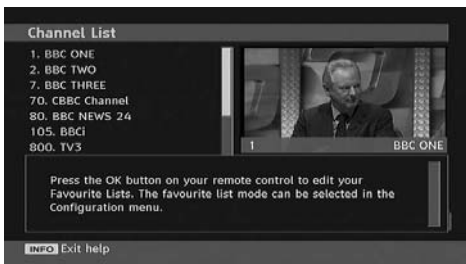

Program Guide

This section is same with the instructions given in the General Operations page. Please see Electronic Programme Guide (EPG) section in the General Operations part.

Timers

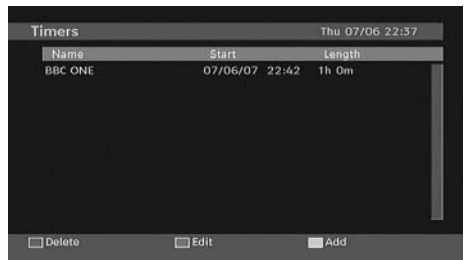

To display timers window, activate the item from the main menu. To add a timer, press the **YELLOW** button on the remote control. Then “Add Timer” window appears.

Channel: “◀” or “▶” keys will navigate the user through the TV or Radio list.

Date: Starting date is entered via the Left/Right or the numeric buttons.

Start: Starting time is entered via the Left/Right or the numeric buttons.

End: Ending time is entered via the Left/Right or the numeric buttons.

Duration: Duration between Start and End time.

Repeat: You can set a timer to be repeated as Once, Daily or Weekly.

Change/Delete: permits or prohibits any modifications for other users.

You can save the adjustments by pressing the GREEN key or cancel the process by pressing the RED button. You can edit the list via GREEN key and delete with the RED button.

Conditional Access

- Press the **MENU** button to display the main menu and use the “▼” or “▲” button to highlight the “Conditional Access” line and press the **OK** button:



Some Digital Terrestrial channels operate on a Pay Per View basis. These require a subscription and a hardware decoder.

Obtain the Conditional Access Module (CAM) and the viewing card by subscribing to a pay channel company, then insert those to the TV using the following procedure.

- Switch off the TV and unplug from the mains.
- Insert the CAM and then the viewing card to the slot that is located in the terminal cover at the left-hand side of the TV (from front view).
- The CAM should be correctly inserted, it is impossible to insert fully if reversed. The CAM or the TV terminal may be damaged if the CAM is forcefully inserted.
- Connect the TV to the mains supply, switch on and then wait for few moments until the card is activated.
- Some CAMs may require the following set up. Please set the CAM by entering the IDTV menu, Conditional Access then pressing the OK button. (CAM set up menu is not displayed when it is not required.)
- To see the viewing contract information: enter IDTV; press the **"MENU"** button, then highlight Conditional Access and press the **OK** button.
- When no module is inserted, "No Conditional Access module detected" message appears on the screen.
- Refer to the module instruction manual for details of the settings.

NOTE: Insert or remove the CI module only when the TV is in STAND-BY mode or SWITCHED OFF.

TV Setup

You can use this item to display the TV functions.

The digital TV Setup menu screen is accessed from the main menu. Press the **"MENU"** button to display the main menu and use **"▼"** or **"▲"** button to highlight **"TV Setup"**, press the **OK** button to display TV Setup menu screen.



You can find detailed information for all menu items in "Analogue TV Menu System" section.

Setup

The adjustments in this menu are given as the following:

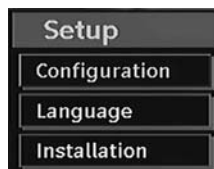

Configuration

You can configure the settings of your TV. Select Configuration from Setup menu and press **OK** to view this menu. Press the **RETURN** button on the remote control to exit.

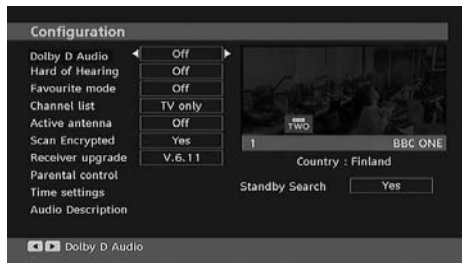

Dolby D Digital (*for EU countries except UK)

*In the Configuration Menu, highlight the Dolby D item by pressing **"▲"** or **"▼"** buttons. Use the **"◀"** or **"▶"** buttons to set the Dolby D Digital as On or Off. If the channel that you are watching supports Dolby Digital, you can turn this setting on.*

Hard of Hearing (*for EU countries except UK)

Use **"▼"** or **"▲"** button to select Hard of Hearing and then press **"◀"** or **"▶"** button to set this setting as On or Off.

If the broadcaster enables any special signal concerning the audio, you can set this setting as On to receive such signals.

Favourite Mode

Use this function to enable or disable favourite mode. Press “◀” / “▶” button to set this function as on or off.

Channel List

Use “▼” or “▲” buttons to go to Channel List option. Use “◀” or “▶” buttons to toggle Channel List Mode. If you select “TV Only”, with the “◀” or “▶” buttons, you navigate through only TV channels. If you select “Radio Only”, with the “◀” or “▶” buttons, you navigate through only radio channels. If you select “Text Only”, with the “◀” or “▶” buttons, you navigate through only text channels. To save the recent changes and exit; press the “MENU” button.

Active Antenna

Use “▼” or “▲” buttons to highlight Active Antenna option.

When antenna power option is set as On by pressing “◀” or “▶” button, +5V will be transmitted to the antenna output.

This feature enables the use of active antenna.

Note: Antenna power should be “Off” when standard antenna is used instead of the active antenna.

Scan Encrypted ()**

(**) For UK only.

Scan Encrypted Channel feature will always be ON after performing first time installation. When this setting is on, search process will locate the encrypted channels as well. If it is set as OFF manually, encrypted channels will not be located while in automatic search or manual search.

Use “▼” or “▲” button to select Scan Encrypted and then press “◀” or “▶” button to set this setting as On or Off.

Receiver Upgrade

Over Air Download (OAD)

To ensure that your TV always has the most update information, use this setting. Please ensure that the TV is set to standby mode. The TV automatically powers up at 3.00 A.M. each day and searches for any new information which may be broadcast and will download this to

your receiver automatically. This operation will normally take approximately 30 minutes. If you have an important recording to be carried out at 3.00 A.M. and you do not want to interrupt it, disable auto OAD search by performing the following:

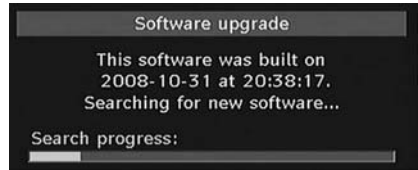

- Press “MENU” button and using the “▼” or “▲” buttons to choose Setup and press the **OK** button.
- Highlight Configuration menu with “▼” or “▲” keys and press **OK**.
- Use “▼” or “▲” buttons to choose “RECEIVER UPGRADE” and press **OK** button.

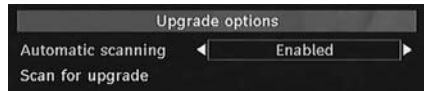

- Using the “◀” or “▶” button change “Automatic scanning” from Enabled to Disabled.
- Highlight “Scan for upgrade” menu with “▼” or “▲” keys and press **OK** to commence upgrade.
- After the search progress is completed, the message “Completed searching for upgrade. No new software was found” appears on the screen if no new software is found.
- Do not forget to re enable the automatic OAD function after you have made your recording by repeating the above instructions but this time selecting **ENABLE**.

Note: Your TV may start in First Time Installation mode after OAD update.

Parental Control

Use “▼” or “▲” buttons to go to Parental Lock option. Press **OK** button to enter the menu. A dialog box asking for the lock key will be displayed. The key is set to “0000” initially. Enter PIN. If it is incorrect, “Wrong Pin” OSD will be displayed. If it is correct, the Parental Control menu will be displayed:



Maturity Lock (**)

(**) If you set Country option as UK in the first time installation, Maturity Lock option will not be visible.

When set, this option gets the maturity information from the broadcast and if this maturity level is disabled, does not show video-audio.

Menu Lock

In menu lock you can set locking for all menus, or the Installation Menu to restrict access to these menus. If the menu lock is disabled, there will be free access to the menu system. Use “▼” or “▲” buttons to go to Menu Lock option. Use “◀” or “▶” buttons to choose Menu Lock Mode.

DISABLED : All menus are unlocked.

ALL MENUS : All Menus are accessible only with the correct lock key. So the user cannot add, delete, rename, channels, cannot set timers.

INSTALLATION MENU: Installation menu is locked. So the user can't add channels. Changes will be updated after exiting 'Configuration Menu'.

Set PIN

Use “▼” or “▲” buttons to go to “Set PIN” option. Press **OK** to display the “Set PIN” window. Use numeric buttons to enter new pin number you will need to input your new pin a second time for verification purposes. If both pin numbers are four digits long and the same, the pin will be changed. The factory default pin number is 0000, if you change the pin number make sure you write it down and keep it safe.

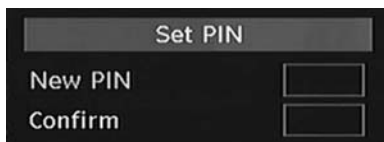

Time Settings (optional)

In the configuration menu, highlight the Time Settings item by pressing “▼” or “▲” buttons. Press **OK** and Time Settings sub menu will be

displayed on the screen. Current Time, Time Zone Setting and Time Zone will be available.

Use “▼” or “▲” buttons to highlight the Time Zone Setting. Time Zone Setting is set using “◀” or “▶” buttons. It can be set to AUTO or MANUAL. When AUTO is selected, Current Time and Time Zone options will not be available to be set. If MANUAL option is selected as the Time Zone Setting, Time Zone can be altered:

- By pressing “▼” or “▲” buttons select Time Zone. Use “◀” or “▶” buttons to change the Time Zone between GMT-12 or GMT+12. Current Time on the top of the menu list will then change according to the selected Time Zone.

Audio Description

Audio description refers to an additional narration track for blind and visually impaired viewers of visual media, including television and movies. The description narrator talks through the presentation, describing what is happening on the screen during the natural pauses in the audio (and sometimes during dialogue, if deemed necessary). You can use this feature, only if the broadcaster supports that additional narration track. Use “▼” or “▲” buttons to select an item. Then use “◀” or “▶” buttons to set.

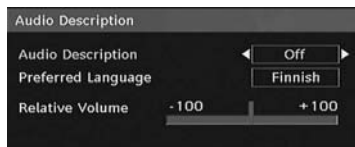

Audio Description

This function enables or disables the audio description feature by pressing the “◀” or “▶” buttons.

Preferred Language

By pressing the “◀” or “▶” buttons the preferred audio description language is being changed.

This setting can be used, only if it is available.

Relative Volume

Using this option, the Audio Description volume level can be increased or decreased relatively, according to the general volume.

Standby Search (optional) (*)

(*) This setting is visible only when the Country option is set to Denmark, Sweden, Norway or Finland.

Use “▼” or “▲” button to select Standby Search and then press “◀” or “▶” button to set this setting as On or Off. If you change Standby Search to Off, this function will be unavailable.

To use Standby search please make sure that you select Standby Search as On.

Language

In this menu the user can adjust the preferred language. Language is changed by pressing OK button.



Menu: shows the language of the system

Preferred

These settings will be used if available. Otherwise the current settings will be used.

- **Audio:** by pressing “◀” or “▶” keys change the audio language.
- **Subtitle:** alter the subtitle language with “◀” or “▶” keys. The chosen language will be seen in subtitles.

Movie Subtitle (optional)

- In order to display subtitles properly, use this setting to select a movie subtitle language.
- By pressing “◀” or “▶” button, select the desired language option.
- **Guide:** By pressing “◀” or “▶” buttons change the guide language.

Current

- **Audio:** if audio language is supported change the audio language by pressing “◀” or “▶” buttons
- **Subtitle:** if subtitle is backed up, alter the subtitle language with “◀” or “▶” buttons. The chosen language will be seen in subtitles.

Note: If the Country option is set to Denmark, Sweden, Norway or Finland, the Language Settings menu will function as described below:

Language Settings



In the Setup menu, highlight the Language Settings item by pressing “▼” or “▲” buttons. Press OK and Language Settings submenu will be displayed on the screen:

Use “▼” or “▲” buttons to highlight the menu item that will be adjusted and then press “◀” or “▶” button to set.

Notes:

- System Language determines the on-screen menu language.
- Audio Language is used for selecting the soundtrack of a channels.
- Primary settings are the first priority when multiple choices are available on a broadcast. Secondary settings are the alternatives when the first options are not available.

Installation

The Installation menu is mainly intended to help you for creating a Channel Table in the most efficient way. Select Installation from the Configuration menu by pressing “▼” or “▲” buttons.

This menu includes the following items:

- Automatic channel scan
- Manual Channel Scan
- Clear Service List (*)
- First Time Installation

(*) For Denmark, Sweden, Norway or Finland.

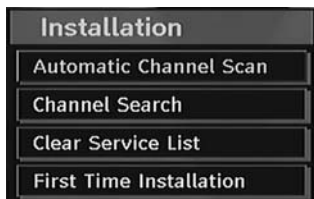

Automatic Channel Scan

Automatic channel scan is started by pressing OK button while Automatic channel scan item is highlighted.

The following message appears on the screen:

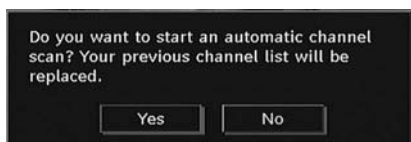

Highlight Yes or No by using "◀" or "▶" buttons and press OK button to confirm.

If Yes is selected, automatic search starts.

Selecting No cancels automatic search.

After search is completed for digital channels, a message asking whether to search for analogue channels appears on the screen:

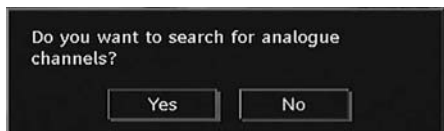

Press the OK button to search for analogue channels. The following menu appears on the screen for analogue channel search:



Select your **Country**, **Language** and **Text language** by using "▼" or "▲" and "◀" or "▶" buttons. Press **OK** or **RED** button to continue. To cancel, press **BLUE** button. The following menu will be displayed during the automatic tuning:

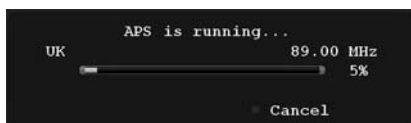

After APS is finalized, the programme table will appear on the screen. In the programme table you will see the programme numbers and names assigned to the programmes.

If you do not accept the locations and/or the programme names, you can change them via the program table.

Manual Channel Scan

In manual channel scan, the number of the multiplex is entered manually and only that multiplex is searched for the channels. For every valid channel number, signal level and signal quality are shown on the screen.

In both manual and auto search any existing channel in the database is not re-stored to avoid redundant duplicates of that channel.

Clear Service List (*)

(*) This setting is visible only when the Country option is set to Denmark, Sweden, Norway or Finland.

Use this setting to clear channels stored. Press "▼" or "▲" button to select Clear Service List and then press OK. The following OSD message will be displayed on the screen:

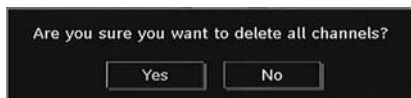

Press OK to cancel. Select Yes by pressing "◀" or "▶" button and press OK to delete all of the channels.

First Time Installation

The user can use this item to load default settings, which were loaded to the receiver at the factory.

To install factory settings, highlight "First Time Installation" menu item and press **OK** button, then you will be asked whether or not to delete

the settings. Selecting “Yes” by pressing **OK** button while the “Yes” is highlighted will delete the existing channel table.

Then you will be asked to confirm for deleting all channels and settings:

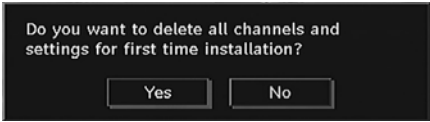

By selecting Yes and pressing the **OK** button, the existing channel table will be deleted.

After factory settings are loaded, “First Time Installation” menu will be displayed.

The menu which is displayed for language selection appears on the screen at first. By using “▼” or “▲” buttons, select the desired language option, and press OK button to activate.

After then, “First time installation” OSD will appear on the screen. By pressing “◀” or “▶” buttons, select the **Country** you want to set and press **OK** button (*For EU countries except UK).

- Next, active antenna mode selection OSD will appear on the screen. Use “◀” or “▶” to set and press OK to continue. See the section, “Initial Settings” for more information.

After active antenna mode option is selected, a message asking for automatic search appears on the screen:

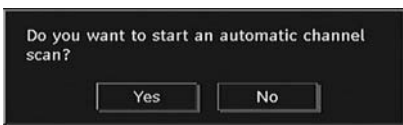

Press the **OK** button to start installation. After search is completed for digital channels, a message asking whether to search for analogue channels appears on the screen:

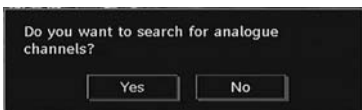

Press the **OK** button to search for analogue channels. The following menu appears on the screen for analogue channel search:



Select your **Country**, **Language** and **TXT Language** by using “▼” or “▲” and “◀” or “▶” buttons. Press **OK** or **RED** button to continue. To cancel, press **BLUE** button. The following menu will be displayed during the automatic tuning:



After APS is finalized, the programme table will appear on the screen. In the programme table you will see the programme numbers and names assigned to the programmes.

If you do not accept the locations and/or the programme names, you can change them via the program table.

Media Browser

- To display Media Browser window, press either “**MENU**” button on the remote control and then select Media Browser by pressing “▼” or “▲” button. Press **OK** button to continue. Media Browser menu contents (depending on the contents of your USB drive) will be displayed.
- Also, when you plug a USB device, the following screen will be displayed:

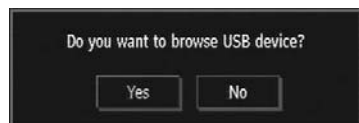

Select YES by pressing “◀” or “▶” button and press OK button. Media browser will be displayed.



- You can play music, picture and video files from a USB memory stick.

Note: If you plug USB stick while in analogue mode, the TV will automatically switch to digital TV mode.

Note: Some USB compliant devices may not be supported.

Note: If the USB stick is not recognized after power off/on or First Time Installation, first, plug the USB device out and power off/on the TV set. Plug the USB device in again.

Note: Movie Sense and Pixelence features cannot be set while in Media Browser mode.

Playing MP3 Files



Play This (OK button) : Plays the selected file.

Play (Green button) : Plays all media files in the folder starting with the selected one.

Pause (Yellow button) : Pause playing file.

Stop (Red button) : Stop the playing file.

Previous/Next (Left/Right buttons) : Jumps to previous or next file to play.

Shuffle (INFO button) : Plays the files randomly. If shuffle mode is enabled, previous/next function will also jump to the tracks randomly.

Loop (Blue button) : Plays the selected file repeatedly.

Viewing JPG Files

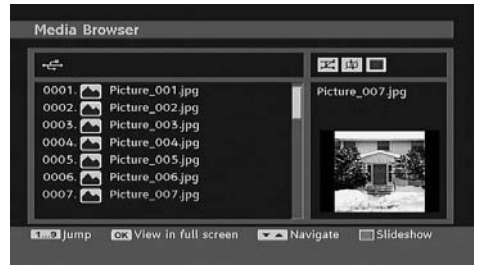

Jump (Numeric buttons) : jump to selected file using the numeric buttons.

OK : views the selected picture in full screen.

Play / Slideshow (Green button) : starts the slideshow with all pictures in the folder.

Slideshow Options



Pause (Yellow button) : Pause the slideshow.

Continue (Green button) : Continue with the slideshow.

Previous/Next (Left/Right buttons) : Jump to previous or next file of slideshow.

Rotate (Up/Down buttons) : Rotate the picture using up/down buttons.

RETURN (exit) : Back to file list.

Shuffle (Red button) : Shows the files randomly and continuous in current folder and  icon turns the highlighted icon. If during a slideshow the shuffle mode is enabled, the next pictures will be chosen randomly (If the loop function is not enabled, the slideshow will stop at the end. If the loop function is enabled, after the slideshow ends, it will start again and again).

Loop : Slideshow goes on continuously and  icon turns the highlighted icon.

Info : Activates the operations bar.

Video Playback

Play (Red button) : Starts the video playback.

Stop (Blue button) : Stops the video playback.

Pause (OK button) : Pause the video playback.

Rewind (Cursor Left) : Goes backward.

Forward (Cursor Right) : Goes forward.

Menu (Menu button) : Sets subtitle/Audio.

- You can set subtitles by using OK button before starting the playback or by using MENU button during the playback.

Press **RETURN** button to switch back to previous menu.

Note: PIP/PAP mode is not available while in Media Browser mode.



Navigating the Analogue TV Menu System

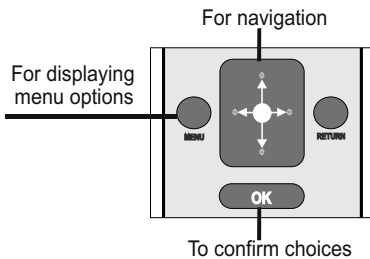

- Press **"MENU"** to display the main menu.
- Press **"◀"** or **"▶"** button to select an icon.
- Use **"▼"** or **"▲"** button to highlight.
- Press **"◀"** or **"▶"** buttons to change the settings.
- Press **"▶"** for more options.
- Press **OK** to store.

- To exit the menu or return from sub-menu screen, press **"MENU"**.

Note: These explanations are valid for the navigation of the analogue TV menu system. To select options that are explained in the following parts, refer to "Navigating the Analogue TV Menu System".

Analogue TV Menu System

Picture Menu



Mode

For your viewing requirements, you can set the related mode option.

Press **"▼"** or **"▲"** button to select **Mode**. Press **"◀"** or **"▶"** button to choose from one of these options: **Cinema**, **Dynamic** and **Natural**.

Brightness/Contrast/Colour/Sharpness/Hue

Press **"▼"** or **"▲"** button to select the desired option. Press **"◀"** or **"▶"** button to set the level.

Note: Hue option can only be visible when the TV receives an NTSC signal.

Colour Temp

Press **"▼"** or **"▲"** button to select **Colour Temp**. Press **"◀"** or **"▶"** to choose from one of these options: **Cool**, **Normal** and **Warm**.

Note:

- Setting **Cool** option gives white colours a slight blue stress.
- Setting **Warm** option gives white colours a slight red stress.
- For normal colours, select **Normal** option.

Noise Reduction

If the broadcast signal is weak and the picture is noisy, use **Noise Reduction** setting to reduce the noise amount.

Press “▼” or “▲” button to select **Noise Reduction**. Press “◀” or “▶” to choose from one of these options: **Low**, **Medium**, **High** or **Off**.

Film Mode

Films are recorded at a different number of frames per second to normal television programmes.

Press “▼” or “▲” button to select **Film Mode**.

Press “◀” or “▶” button to set this feature On or Off.

Turn this feature on when you are watching films to see the fast motion scenes clearly.

Game Mode

Select **Game Mode** by pressing “▼” or “▲” button. Use “◀” or “▶” button to set Game Mode as **On** or **Off**. When Game Mode is set to On, specific game mode settings, which are optimized for better video quality, will be loaded.

Also; Picture Mode, Contrast, Brightness, Sharpness, Colour and Colour Temp settings will be invisible and disabled while Game Mode is on.

Note:

Picture mode selection button on the remote control will have no function while Game Mode is on.

If the TV is switched to PIP/PAP mode, Game Mode setting will be disabled and be removed from the Picture menu.

Picture Zoom

Select **Picture Zoom** by pressing “▼” or “▲” button.

Use “◀” or “▶” buttons, to change picture zoom to **Auto**, **16:9**, **4:3**, **Panoramic**, **14:9**, **Cinema**, **Subtitle** or **Zoom**.

Reset

Press “▼” or “▲” button to select **Reset**. Press “◀” or “▶” or **OK** button to reset the picture modes to factory default settings.

Store

Press “▼” or “▲” button to select **Store**. Press “▶” or **OK** button to store the settings. “**Stored...**” will be displayed on the screen.

Sound Menu



Volume

Press “▼” or “▲” button to select **Volume**. Press “◀” or “▶” button to change the level of the Volume.

Equalizer

Press “▼” or “▲” button to select **Equalizer**. Press “▶” button to view equalizer menu.

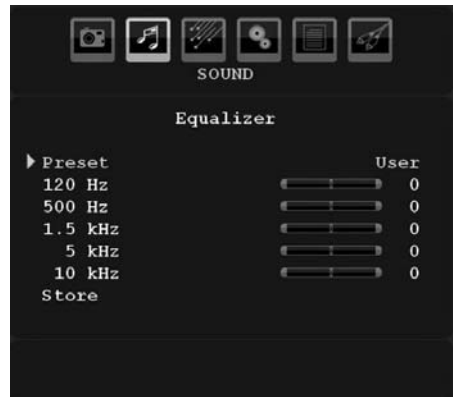

Press “◀” or “▶” button to change the preset. In equalizer menu, the preset can be changed to **Musical**, **Movie**, **Speech**, **Flat**, **Classic** and **User**.

Select the desired frequency by pressing “▼” or “▲” button and increase or decrease the frequency gain by pressing “◀” or “▶” button.

Press the “**MENU**” button to return to the previous menu.

*Note: Equalizer menu settings can be changed only when the **Equalizer Mode** is in **User**.*

Balance

This setting is used for emphasizing left or right speaker balance.

Press “**▼**” or “**▲**” button to select **Balance**. Press “**◀**” or “**▶**” button to change the level of the balance. Balance level can be adjusted between **-32** and **+ 32**.

Headphone

Press “**▼**” or “**▲**” button to select **Headphone**. Press “**▶**” button to view the headphone menu.

Headphone sub-menu options are described below:

Volume

Press “**▼**” or “**▲**” button to select **Volume**. Press “**▶**” button to increase headphone volume level. Press “**◀**” button to decrease headphone volume level. Headphone volume level can be adjusted between 0 and 63.

Store

Press “**▼**” or “**▲**” button to select **Store**. Press “**▶**” or **OK** button to store the settings. “**Stored...**” will be displayed on the screen.

Sound Mode

Press “**▼**” or “**▲**” button to select **Sound Mode**. Using “**◀**” or “**▶**” button, you can select Mono, Stereo, Dual I or Dual II mode, only if the selected channel supports that mode.

AVL

Automatic Volume Limiting (AVL) function adjusts the sound to obtain fixed output level between programmes (For instance, volume level of advertisements tend to be louder than programmes).

Press “**▼**” or “**▲**” button to select **AVL**. Press “**◀**” or “**▶**” button to set the AVL as **On** or **Off**.

Effect

If you are watching a mono broadcast, set Effect on to obtain a better sound effect which will be more stereo-like. If the current sound system is stereo, switching this effect on will give a more spatial effect.

Press “**▼**” or “**▲**” button to select Effect. Press “**◀**” or “**▶**” button to set as On or Off .

Store

Press “**▼**” or “**▲**” button to select Store. Press “**▶**” or **OK** button to store the settings. “**Stored...**” will be displayed on the screen.

Feature Menu



Pip-Pap

In the **Feature** menu, highlight **PIP** item by pressing “**▼**” or “**▲**” buttons. Press “**▶**” button to enter **PIP** submenu:



Using “**◀**” or “**▶**” button, you can switch to PIP, PAP mode or turn off the feature.

If the TV is switched to PIP or PAP mode, Pip-Pap submenu will change accordingly and the following settings will appear on the same menu screen.

Note that if you switch to PAP mode by using Pip-Pap setting, only Source and Swap options will be active among the menu settings.

Pip-Pap

This line controls Pip/Pap modes. Use “◀” or “▶” buttons to switch the TV to **Pip**, **Pap** or **Off**.

Pip Size

Using this setting, you can set the size of the Pip window. Press “▼” or “▲” button to highlight Pip Size item. Use “◀” or “▶” button to set Pip Size to Small or Large.

Note: This setting will be inactive if the TV is set to Pap mode.

PIP Position

This setting is used for moving the sub picture.

Select PIP Position item by using “▼” or “▲” button. Use “◀” or “▶” button to adjust PIP position.

Positions available are: Bottom Right, Bottom Left, Top Left and Top Right.

Source

PIP Source setting enables you to select the source of the sub picture.

Select PIP Source item by using “▼” or “▲” button. Use “◀” or “▶” button to set **PIP source**.

Program

This setting will be unavailable to be used.

Swap

Select **Swap** item by using “▼” or “▲” button. Use “◀” or “▶” button to set. This function enables to swap between the main and the PIP picture.

Note: See Appendix E for all PIP/PAP modes.

Sleep Timer

Press “▼” or “▲” button to select **Sleep Timer**. Use “◀” or “▶” button to set the **Sleep Timer**.

The timer can be programmed between **Off** and **120** minutes in steps of **10** minutes.

If **Sleep Timer** is activated, at the end of the selected time, the TV goes automatically to standby mode.

Child Lock

Press “▼” or “▲” button to select **Child Lock**.

Use “◀” or “▶” button to set the Child Lock **On** or **Off**. When On is selected, the TV can only be controlled by the remote control handset. In

this case the control panel buttons (except for the **STANDBY** button) will not work.

Hence, if one of those buttons is pressed, **Child Lock On** will be displayed on the screen when the menu screen is not visible.

Language

Press “▼” or “▲” button to select **Language**. Use “◀” or “▶” button to select the **Language**.

Default Zoom

While zoom mode is set as AUTO, the TV will set the zoom mode in accordance with the signal of the broadcast. If there is no WSS or aspect ratio information, the TV will then use this setting to adopt. Press “▼” or “▲” button to select **Default Zoom**. You can set **Default Zoom** to **Panoramic**, **16:9**, **4:3** or **14:9** by pressing “◀” or “▶” button.

Blue Background

If the signal is weak or absent, the TV will automatically change to a blue screen. To enable this, set **Blue Background** to **On**.

By pressing “▼” or “▲” button, select **Blue Background**. Press “◀” or “▶” button to set **Blue Background** as **On** or **Off**.

Menu Background

Press “▼” or “▲” button to select **Menu Background**. You can set menu background level by pressing “◀” or “▶” button.

Power Save Mode

Use “▼” or “▲” button to select Power Save Mode.

Press “◀” or “▶” button to set Power Save Mode as On or Off.

See the section, “Environmental Information” in this manual for further information on Power Save Mode.

Note : Backlight function will be invisible if Power Save Mode is set to on.

Backlight

This setting controls the backlight level. Select **Backlight** by pressing “▼” or “▲” button. Press “◀” or “▶” button to set **Backlight** to **Auto**, **Medium**, **Maximum** or **Minimum**.

Menu Timeout

To set a specific display timeout for menu screens, set a value for this option.

Press “▼” or “▲” button to select **Menu Timeout**. Use “◀” or “▶” button to change menu timeout to **15 sec, 30 sec** or **60 sec**.

Teletext Language

Press “▼” or “▲” button to select **Teletext Language**. Use “◀” or “▶” button to change **Teletext Language** to **West, East, Turk/Gre, Cyrillic, Arabic** or **Persian**.

HDMI PC Full Mode

If you want to view PC screen in HDMI mode by using external connection, HDMI PC FULL MODE option should be On to adjust the screen ratio correctly. This item might be inactive in some resolutions.

Full Mode (optional)

If you connect a device via HDMI or YPbPr connectors and set 1080i/1080P resolutions, Full Mode item will be visible. You can set Full Mode as 1:1 or Normal by using “◀” or “▶”. If you select 1:1, screen ratio will be adjusted correctly. If you set Normal, screen ratio may expand.

Ext Out

Press “▼” or “▲” button to select Ext Out. Use “◀” or “▶” button to set the Ext Out as On or Off.

Note:

For copying from a DVD or VCR device, you should choose desired source from source menu and turn “On” to EXT Out from feature menu.

Note : If you do not want Tuner video out put from Scart 1 or Scart 2, please set the Ext Out as Off , otherwise you can set it as On.

Install Menu



Program

Press “▼” or “▲” button to select Program. Use “◀” or “▶” button to select the program number.

You can also enter a number using the numeric buttons on the remote control. There are 200 programme storage between 0 and 199.

Band

Band can be selected either C or S. Press “◀” or “▶” button to set Band.

Channel

Channel can be changed by “◀” or “▶” button or numeric buttons.

Colour System

Press “▼” or “▲” button to select Colour System. Use “◀” or “▶” button to change the colour system to PAL, PAL 60, SECAM or AUTO.

Sound System

Press “▼” or “▲” button to select Sound System. Press “◀” or “▶” button to change the sound system to BG, DK, I, L or L'.

Fine Tune

Press “▼” or “▲” button to select Fine Tune. Press “◀” or “▶” button to adjust the tuning.

Search

Press “▼” or “▲” button to select Search. Use “◀” or “▶” button to start programme searching. You can also enter the desired frequency using the numeric buttons while Search item is highlighted.

Store

Press “▼” or “▲” button to select Store. Press “▶” or **OK** button to store the settings. “**Stored...**” will be displayed on the screen.

Install Menu in AV Modes

The following screen appears in the install menu when the TV is in AV modes. Note that limited options will be available. Switch to TV mode for viewing complete version of the **Install** menu.



Colour System

Press “▼” or “▲” button to select **Colour System**. Use “◀” or “▶” button to change the colour system to **PAL, SECAM, PAL60, AUTO, NTSC 4,43** or **NTSC 3,58**.

Store

Press “▼” or “▲” button to select **Store Program**. Press “▶” or **OK** button to store the settings. “Stored...” will be displayed on the screen.

Program Table

Select **Program Table** by pressing “◀” or “▶” button.



By moving the cursor in four directions you can reach 20 programmes in the same page. You can scroll the pages up or down by pressing the navigation buttons to see all the programmes in TV mode (except for the AV modes). By cursor action, programme selection is done automatically.

Name

To change the name of a programme, select the programme and press the **RED** button.

The first letter of the selected name will be highlighted. Press “▼” or “▲” button to change that letter and “◀” or “▶” button to select the other letters. By pressing the **RED** button, you can store the name.

Move

Select the programme which you want to insert by navigation buttons. Press the **GREEN** button. By navigation buttons move the selected programme to the decided programme space and press the **GREEN** button again.

Delete

To delete a programme, press the **YELLOW** button. Pressing the **YELLOW** button again erases the selected programme from the programme list, and the following programmes shift one line up.

APS (Auto Programming System)

When you press the **BLUE** button for starting automatic tuning, **Auto Programming System** menu will appear on the screen:

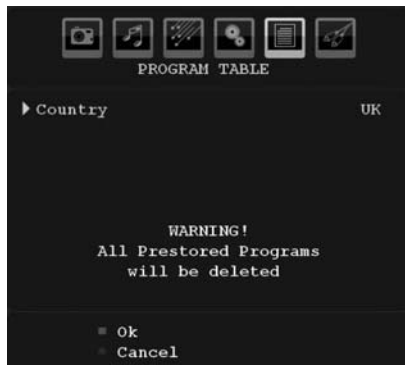

Country

Press “◀” or “▶” button to select your country. If you want to exit from A.P.S. function, press the **BLUE** button.

When you press **OK** or **RED** button for starting automatic tuning, all stored programmes will be erased and the TV will search for available channels. During the search, the following OSD will be displayed:

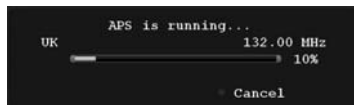

Whenever you press the **BLUE** button, APS function stops and Program Table appears on the screen.

If you wait until the end of APS, Program Table will be displayed with the programmes found and located.

Source Menu

Press “▼” or “▲” button and select the sixth icon. Then press “▶” or **OK** button. Source menu appears on the screen:



In source menu, highlight a source by pressing “▼” or “▲” button and switch to that mode by pressing “▶” button. Source options are; **TV, DTV/USB, EXT-1, EXT-2, EXT-2S, FAV, SIDE AV, HDMI-1, HDMI-2, HDMI-3, HDMI-4, YPbPr or PC-VGA.**

Note: Once you have connected optional equipment systems to your TV, you should select the required input to view pictures from that source.

PC Mode Menu System

See “**Connecting the LCD TV to a PC**” section for connecting a PC to the TV set.

For switching to **PC** source, press “**SOURCE**” button on your remote control and select PC input. You can also use “**Source**” menu to switch to **PC** mode.

Note that PC mode menu settings are available only while the TV is in PC source.

PC Position Menu

Select the first icon by pressing “◀” or “▶” button. **PC Position** menu appears on the screen:



Autoposition

If you shift the picture horizontally or vertically to an unwanted position, use this item to put the picture into correct place automatically. This setting therefore automatically optimizes the display.

Select Autoposition item by using “▼” or “▲” buttons. Press **OK** or “◀”, “▶” button.

Warning: Please ensure auto adjustment is performed with a full screen image to ensure best results.

H (Horizontal) Position

This item shifts the image horizontally to right hand side or left hand side of the screen.

Select **H Position** item by using “▼” or “▲” button. Use “◀” or “▶” button to adjust the value.

V (Vertical) Position

This item shifts the image vertically towards the top or bottom of the screen.

Select **V Position** item by using “▼” or “▲” button. Use “◀” or “▶” button to adjust the value.

Phase

Depending on the resolution and scan frequency that you input to the TV set, you may see a hazy or noisy picture on the screen. In such a case you can use this item to get a clear picture by trial and error method.

Select **Phase** item by using “▼” or “▲” buttons. Use “◀” or “▶” button to adjust the value.

Dot Clock

Dot Clock adjustments correct the interference that appear as vertical banding in dot intensive presentations like spreadsheets or paragraphs or text in smaller fonts.

Select **Dot Clock** item by using “▼” or “▲” buttons. Use “◀” or “▶” button to adjust the value.

PC Picture Menu

For adjusting PC picture items, do the following:

Press “◀” or “▶” button to select the second icon. PC Picture menu appears on the screen.

Brightness, Contrast, Colour and Colour Temperature settings in this menu are identical

to settings defined in TV picture menu under “Analogue TV Menu System”.

Note: If you set Colour Temp as User, you can define R, G, B settings manually.

Sound Menu

The items in this menu are described at “**Sound Menu**” section explained in “**Menu System**”.

Feature Menu

Feature menu settings are identical to the settings explained in “**Feature Menu**” section in “**Menu System**”.

Source Menu

Source menu settings are identical to the settings explained in “**Source Menu**” section in “**Menu System**”.

Displaying TV Information

Programme Number, **Programme Name**, **Sound Indicator** and **Zoom Mode** information is displayed on the screen when a new programme is entered or **INFO** button is pressed.

Mute Function



Press “” button to disable sound. Mute indicator will be displayed in the upper side of the screen.

To cancel mute, there are two alternatives; the first one is pressing the “” button and the second one is increasing the volume level.

PIP (Picture-in-Picture) Mode



Press the “PIP” button to switch to PIP mode.

In PIP Mode, a small picture (PIP picture) is displayed on the main picture. There is 1 size and 4 positions (upper left, upper right, bottom left and bottom right) available for the PIP window. Aspect Ratio of the PIP window is fixed and 4:3.

When PIP Mode is entered, the default active window is the PIP window and the active window is indicated by a red frame around it. The active window can be changed by pressing “” or “” button. The status info OSD belongs to active window. The place of the status OSDs are same for both windows.

Press the “PIP” button again to switch to PAP mode.

In PAP Mode, two pictures with equal sizes are displayed on the screen. Aspect Ratios of the windows are fixed.

The active window can be changed by pressing “” or “” button.

Press the “PIP” button again to exit the PAP mode.

Picture Mode Selection

By pressing **PRESETS** button, you can change **Picture Mode** settings in accordance with your viewing requirements. Available options are Dynamic, Natural and Cinema.

Note : This function will not be available while in PC mode.

Freezing Picture

You can freeze the picture on the screen by pressing the “**OK**” button on the remote control. Press the “**OK**” button to freeze picture. Press again to quit freeze mode.

Note: This function will not be available while in DTV mode.

Zoom Modes

You can change the aspect ratio (image size) of the TV for viewing the picture in different zoom modes.

Press “**SCREEN**” button to directly change the zoom mode.

Available zoom modes are listed below.

Note:

In **YPbPr** and **HDMI** modes, while in 720p-1080i resolutions, only 16:9 mode is available.

In **PC** mode, only **16:9** mode is available.

Auto

When a **WSS (Wide Screen Signalling)** signal, which shows the aspect ratio of the picture, is included in the broadcast signal or the signal from an external device, the TV automatically changes the **ZOOM** mode according to the **WSS** signal.

- When the **AUTO** mode does not function correctly due to poor **WSS** signal quality or when you want to change the **ZOOM** mode, change to another **ZOOM** mode manually.

16:9

This uniformly stretches the left and right sides of a normal picture (4:3 aspect ratio) to fill the wide TV screen.



- For 16:9 aspect ratio pictures that have been squeezed into a normal picture (4:3 aspect ratio), use the **16:9** mode to restore the picture to its original shape.

4:3

Use to view a normal picture (4:3 aspect ratio) as this is its original size.



Panoramic

This stretches the left and right sides of a normal picture (4:3 aspect ratio) to fill the screen, without making the picture appear unnatural.



The top and bottom of the picture are slightly cut off.

14:9

This zooms up the wide picture (14:9 aspect ratio) to the upper and lower limits of the screen.



Cinema

This zooms up the wide picture (16:9 aspect ratio) to the full screen.

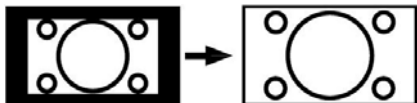

Subtitle

This zooms up the wide picture (16:9 aspect ratio) with subtitles to the full screen.



Zoom

This option zooms to the picture.

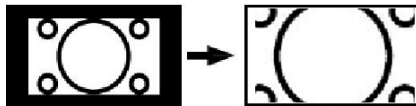

Note: You can shift to screen up or down by pressing “▼” / “▲” buttons while picture zoom is selected as panoramic, 14:9, Cinema or Subtitle.

Teletext

Teletext system transmits information such as news, sports and weather on your TV. Note that if the signal degrades, for example in poor/adverse weather conditions, some text errors may occur or the teletext mode may be aborted.

Teletext function buttons are listed below:

“” **Teletext On-Off/Mix/PAT mode**

Activates teletext mode when pressed once. Pressing this button again will split the screen into two windows, one displaying the teletext and the other displaying the current channel. Pressing again will quit the teletext mode.

“**RETURN**” **Index**

Selects the teletext index page.

Expand

Press once to enlarge top half of the page, press again to enlarge the bottom half of the page. Press again to revert back to normal size.

“” **Reveal**

Shows hidden information (e.g. solutions of games).

“**OK**” **Hold**

Holds a text page when convenient. Press again to resume.

“” **Subcode Pages / Time**

Selects subcode pages if available when the teletext is activated. When the teletext is not

activated, displays time info if the programme has teletext transmission.

P+ / P- and numbers (0-9)

Press to select a page.

Note: Most TV stations use code 100 for their index pages.

Coloured Buttons

(RED/GREEN/YELLOW/BLUE)

Your TV supports both **FASTTEXT** and **TOP text** systems. When these systems are available, the pages are divided into groups or topics.

When **FASTTEXT** system is available, sections in a teletext page will become colour-coded and can be selected by pressing the coloured buttons. Press a coloured button that corresponds to with your needs.

The coloured writings will appear, showing you which coloured buttons to use when **TOP text** transmission is present. Pressing **P -** or **P +** commands will request the next or previous page respectively.

TXT (Teletext) Subtitle

If you press **SUBTITLE** button, teletext subtitle information will be displayed on the bottom right part of the screen (if available). You can set the desired option by highlighting it using “▼” or “▲” button and then by pressing OK button.

Tips

Screen Care

Clean the screen with a slightly damp, soft cloth. Do not use abrasive solvents as they may damage the coating layer of the TV screen.

For your safety, unplug the mains plug when cleaning the set. When moving the TV, hold it properly from the bottom part.

Image Persistence

Please note that ghosting may occur while displaying a persistent image. LCD TVs' image persistence may disappear after a short time. Try turning off the TV for a while.

To avoid this, do not leave the screen in still picture for extended periods.

No Power

If your TV system has no power, please check the main power cable and connection to the mains socket outlet.

Poor Picture

Have you selected the correct TV system? Is your TV set or house aerial located too close to a non-earthed audio equipment or neon lights, etc.?

Mountains or high buildings can cause double pictures or ghost images. Sometimes you can improve the picture quality by changing the direction of the aerial.

Is the picture or teletext unrecognisable? Check if you have entered the correct frequency. Please retune the channels.

The picture quality may degrade when two peripherals are connected to the TV at the same time. In such a case, disconnect one of the peripherals.

No Picture

Is the aerial connected properly? Are the plugs connected tightly to the aerial socket? Is the aerial cable damaged? Are suitable plugs used to connect the aerial? If you are in doubt, consult your dealer.

No Picture means that your TV is not receiving a transmission. Have you selected the correct button on the remote control? Try once more.

Also make sure the correct input source has been selected.

Sound

You can not hear any sound. Did you perhaps interrupt the sound, pressing the  button?

Sound is coming from only one of the speakers. Is the balance set to one extreme? See **Sound Menu**.

Remote Control

Your TV no longer responds to the remote control. Perhaps the batteries are exhausted. If so you can still use the local buttons at the bottom of the TV.

Input Sources

If you cannot select an input source, it is possible that no device is connected.

Check the AV cables and connections if you have tried to connect a device.

Appendix A: PC Input Typical Display Modes

The display has a maximum resolution of 1920 x 1200. The following table is an illustration of some of the typical video display modes.

Your TV may not support different resolutions. Supported resolution modes are listed below.

If you switch your PC to an unsupported mode, a warning OSD will appear on the screen.

Note: Resolution modes indicated with (*) are not available for PIP/PAP modes.

Index	Resolution		Frequency		Standard
	Hor	Ver	Ver (Hz)	Hor (KHz)	
1	640	350	85	37.9	VESA
2	640	400	85	37.9	VESA
3	640	400	70	31.5	IBM VGA
4	640	480	60	31.5	VESA
5	640	480	66	35.0	MAC
6	640	480	72	37.9	VESA
7	640	480	75	37.5	VESA
8	640	480	85	43.3	VESA
9	800	600	56	35.2	VESA
10	800	600	60	37.9	VESA
11	800	600	70	43.8	
12	800	600	72	48.1	VESA
13	800	600	75	46.9	VESA
14	800	600	85	53.7	VESA
15	832	624	75	49.7	MAC
16	1024	768	43	35.5	VESA (interlace)
17	1024	768	60	48.4	VESA
18*	1024	768	70	56.5	VESA
19*	1024	768	72	57.7	
20*	1024	768	75	60.0	
21*	1024	768	85	68.3	
22	1152	864	60	53.8	
23*	1152	864	70	64.2	VESA
24*	1152	864	75	67.5	VESA
25*	1152	864	85	77.1	VESA
26*	1152	870	75	68.9	MAC
27	1280	768	60	47.7	VESA
28	1360	768	60	47.7	
29*	1280	768	75	60.2	VESA
30	1280	960	60	60.0	VESA
31*	1280	960	75	75.0	VESA
32*	1280	960	85	85.9	VESA
33	1280	1024	60	64.0	VESA
34*	1280	1024	75	80.0	VESA
35*	1280	1024	85	91.1	VESA
36	1400	1050	60	65.3	
37*	1400	1050	75	82.3	
38	1440	900	60	55.9	
39*	1440	900	75	70.6	
40*	1600	1200	60	75.0	VESA
41*	1920	1200	60	74.5	

Appendix B: Supported DVI Resolutions

When connecting devices to your TV's connectors by using DVI converter cables (not supplied), you can refer to the following resolution information.

	24Hz	25Hz	30Hz	50Hz	60Hz
480i					<input checked="" type="checkbox"/>
480p					<input checked="" type="checkbox"/>
576i				<input checked="" type="checkbox"/>	
576p				<input checked="" type="checkbox"/>	
720p				<input checked="" type="checkbox"/>	<input checked="" type="checkbox"/>
1080i				<input checked="" type="checkbox"/>	<input checked="" type="checkbox"/>
1080p	<input checked="" type="checkbox"/>	<input checked="" type="checkbox"/>	<input checked="" type="checkbox"/>	<input checked="" type="checkbox"/>	<input checked="" type="checkbox"/>

Appendix C: AV and HDMI Signal Compatibility (Input Signal Types)

Source	Supported Signals		Available
EXT-1 (SCART 1)	PAL 50/60		O
	NTSC 60		O
	RGB 50		O
	RGB 60		O
EXT-2 (SCART-2)	PAL 50/60		O
	NTSC 60		O
	RGB 50		X
	RGB 60		X
	S-VHS 50		O
	S-VHS 60		O
FAV	PAL 50/60		O
	NTSC 60		O
YPbPr	480I	60Hz	O
	480P	60Hz	O
	576I	50Hz	O
	576P	50Hz	O
	720P	50Hz	O
	720P	60Hz	O
	1080I	50Hz	O
	1080I	60Hz	O
HDMI1 HDMI2 HDMI3 HDMI4	480I	60Hz	O
	480P	60Hz	O
	576I	50Hz	O
	576P	50Hz	O
	720P	50Hz	O
	720P	60Hz	O
	1080I	50Hz	O
	1080I	60Hz	O
	1080P	50Hz	O
	1080P	60Hz	O
	1080P	24 HZ	O

(X: Not Available, O: Available)

Note: In some cases a signal on the LCD TV may not be displayed properly. The problem may be an inconsistency with standards from the source equipment (DVD, Set-top box, etc.). If you do experience such a problem please contact your dealer and also the manufacturer of the source equipment.

Appendix D: Pin Specifications

SCART connector pin specifications

Pin	Input signal	Pin	Input signal
1	AUDIO OUT (RIGHT)	12	Not used
2	AUDIO IN (RIGHT)	13	RGB-R GND
3	AUDIO OUT (LEFT/MONO)	14	GND
4	AUDIO GND	15	RGB-R / S.VHS CHROMINANCE IN
5	RGB-B GND	16	BLANKING SIGNAL
6	AUDIO IN (LEFT/MONO)	17	COMPOSITE VIDEO GND
7	RGB-B IN	18	BLANKING SIGNAL GND
8	AUDIO / RGB SWITCH / 16:9	19	COMPOSITE VIDEO OUT
9	RGB-G GND	20	COMPOSITE VIDEO / S.VHS LUMINANCE IN
10	Not used	21	GND / SHIELD (CHASSIS)
11	RGB-G IN		

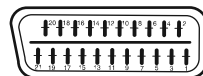

HDMI connector pin specifications

Pin	Input signal	Pin	Input signal
1	TMDS Data2+	11	TMDS Clock Shield
2	TMDS Data2 Shield	12	TMDS Clock-
3	TMDS Data 2-	13	CEC
4	TMDS Data 1+	14	Reserved (N.C. on device)
5	TMDS Data1 Shield	15	SCL
6	TMDS Data1-	16	SDA
7	TMDS Data0+	17	DDC/CEC Ground
8	TMDS Data0 Shield	18	+5V Power
9	TMDS Data0-	19	Hot Plug Detect
10	TMDS Clock+		

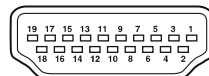

Signal Input

PC RGB Terminal (D-sub 15-pin connector)

Pin	Input signal
1	R
2	G or sync on green
3	B
4	No connection
5	No connection
6	R.GND
7	G.GND
8	B.GND
9	No connection
10	GND
11	No connection
12	[SDA]
13	H.sync or H/V composite sync
14	V.sync. [V.CLK]
15	[SCL]

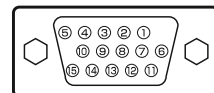

S-input connector pin specifications

Pin	Input signal
1	Y
2	Y-GND
3	C
4	C-GND
Frame	GND

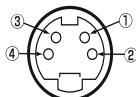

Appendix E: PIP/PAP Mode Combinations

MAIN	TV	DTV/ USB	Scart1	Scart2	Scart2S	FAV	SVHS	HDMI1	HDMI2	HDMI3	HDMI4	YPbPr	PC- VGA
TV	✗	✗	✓ (RGB)	✗	✗	✗	✗	✓	✓	✓	✓	✓	✓
DTV/ USB	✗	✗	✓	✓	✓	✓	✓	✓	✓	✓	✓	✓	✓
Scart1	✓ (RGB)	✓	✗	✓ (RGB)	✓ (RGB)	✓ (RGB)	✓ (RGB)	✓	✓	✓	✓	✓	✓
Scart2	✗	✓	✓ (RGB)	✗	✗	✗	✗	✓	✓	✓	✓	✓	✓
Scart2S	✗	✓	✓ (RGB)	✗	✗	✗	✗	✓	✓	✓	✓	✓	✓
FAV	✗	✓	✓ (RGB)	✗	✗	✗	✗	✓	✓	✓	✓	✓	✓
SVHS	✗	✓	✓ (RGB)	✗	✗	✗	✗	✓	✓	✓	✓	✓	✓
HDMI1	✓	✓	✓	✓	✓	✓	✓	✗	✗	✗	✗	✓	✓
HDMI2	✓	✓	✓	✓	✓	✓	✓	✗	✗	✗	✗	✓	✓
HDMI3	✓	✓	✓	✓	✓	✓	✓	✗	✗	✗	✗	✓	✓
HDMI4	✓	✓	✓	✓	✓	✓	✓	✗	✗	✗	✗	✓	✓
YPbPr	✓	✓	✓	✓	✓	✓	✓	✓	✓	✓	✓	✗	✓
PC- VGA	✓	✓	✓	✓	✓	✓	✓	✓	✓	✓	✓	✓	✗

(RGB): This indicates that, selection is possible only if Scart-1 has a RGB signal.

Restrictions: Scart-1 source must have RGB signal to perform PIP\PAP with sources TV, Scart-2, Scart-2 S, FAV, SVHS.

If these sources are set to main window, and Scart-1 does not have a RGB signal, Pip\Pap source can not be switched to the Scart-1 source.

If scart-1 source is set to main window, and scart-1 does not have a RGB signal, Pip\Pap source can not be switched to TV, Scart-2, Scart-2 S, FAV and SVHS sources.

Appendix F: Supported File Formats for USB Mode

Media	File Extension	Format		Remarks
		Video	Audio	(Maximum resolution/Bit rate etc.)
Music	-	-	PCM	Sample Rate: 8K ~ 48KHz
	.mp3	-	MPEG 1/2 Layer 1/ 2/ 3 (MP3)	Sample Rate: 8K ~ 48KHz, Bit Rate: 32K~320Kbps
Photo	.jpg	Baseline JPEG		WxH = 14592x12288, Up to 179 Mega-pixel Support format: 444/ 440/ 422/ 420/ Grayscale
		Progressive JPEG		Up to 4 Mega-pixel Support format: 444/ 440/ 422/ 420/ Grayscale
	.gif	GIF		WxH = 14592x12288, Up to 179 Mega-pixel
	.bmp	bit map		WxH = 14592x12288, Up to 179 Mega-pixel

Specifications

TV BROADCASTING

PAL/SECAM B/G D/K K' I/I' L/L'

RECEIVING CHANNELS

VHF (BAND I/III)

UHF (BAND U)

HYPERBAND

Digital Reception	MHEG-5 ENGINE compliant with ISO/IEC 13522-5 UK engine Profile 1	for UK
	Object carousel support compliant with ISO/IEC 135818-6 and UK DTT profile	
	Frequency range: 474-850 MHz for UK models	
	170-862 MHz for EU models	
	Transmission standard: DVB-T. MPEG-2	
	Demodulation: COFDM with 2K/8K FFT mode	
	FEC: all DVB modes	
	Video: MP@ML, PAL, 4:3/16:9	
	Audio: MPEG Layer I&II 32/44.148kHz.	

NUMBER OF PRESET CHANNELS

200

CHANNEL INDICATOR

On Screen Display

RF AERIAL INPUT

75 Ohm (unbalanced)

OPERATING VOLTAGE

220-240V AC, 50 Hz.

AUDIO

German + Nicam Stereo

AUDIO OUTPUT POWER (W_{RMS}) (10% THD)

2 x 8

POWER CONSUMPTION (W)

250 W (max)

250 mW (Standby)

PANEL

46" Wide Display

DIMENSIONS (mm)

DxLxH (With foot): 296 x 1129 x 766

Weight (Kg): 33.00

DxLxH (Without foot): 110 x 1129 x 716

Weight (Kg): 28.00

DVB-T functionality information

This DVB receiver is only suitable for use in the country which it was designed to be used in.

Although this DVB receiver conforms to the latest DVB specifications at the time of manufacture, we cannot guarantee compatibility with future DVB transmissions due to changes that may be implemented in broadcast signals and technologies.

Some digital television functions may not be available in all countries.

We continually strive to improve our products; therefore, specifications may change without prior notice.

For advice on where to purchase accessories, please contact the store where you purchased your equipment.

Environmental Information

- This television is designed to consume less energy to save environment.

You not only help to save the environment but also you can save money by reducing electricity bills thanks to the energy efficiency feature of this TV. To reduce energy consumption, you should take the following steps:

- You can use Power Save Mode setting, located in the Feature menu. If you set Power Save Mode as On, the TV will switch to energy-saving mode and luminance level of TV set will be decreased to optimum level. Note that some picture settings will be unavailable to be changed when the TV is in Power Save Mode.

Power Save Mode On

- When the TV is not in use, please switch off or disconnect the TV from the mains plug. This will also reduce energy consumption.
- Disconnect power when going away for longer time.
- Note that annually, using the TV set in Power Save Mode has more power efficiency than disconnecting the TV from the mains plug instead of keeping stand-by mode. Therefore disconnect the TV from the mains plug to save energy when you do not use. However it is highly recommended to activate Power Save Mode setting to reduce your annual power consumption.
- Please helps us to save environment by following these steps.

Repair Information

Please refer all servicing to qualified personnel. Only qualified personnel must repair the TV. Please contact your local dealer, where you have purchased this TV for further information.

Product Guarantee

This product is guaranteed against manufacturing defects for a period of

1 Year

This does not cover the product where the fault is due to misuse, abuse, use in contravention of the instructions, or where the product has been the subject of unauthorised modifications or alterations, or has been the subject of commercial use

In the event of a problem with the product within the guarantee period please return it to your nearest store

If the item is shown to have had an inherent defect present at the time of sale, the store will provide you with a replacement

Your statutory rights remain unaffected

Guarantor; Home Retail Group
489 - 499 Avebury Boulevard
Central Milton Keynes
MK9 2NW

HITACHI
Inspire the Next