

HITACHI

Inspire the Next

22" LCD Colour Television
with integral DVD player

Instructions for use

GB

L22DG07U

HDMITM
HIGH-DEFINITION MULTIMEDIA INTERFACE

digital 
Approved product

FULL HD 1080

Freeview[★]



For any TV set up or usage issues
Technical Helpline No. 0845 604 0105

Lines are open 9am - 8pm Monday to Saturday and
11am - 5pm Sunday. Calls charged at local rate.

HITACHI

Contents

Features	2	Analogue Fine Tune.....	15
Introduction.....	2	Managing Stations: Channel List.....	15
Preparation.....	2	Operating the Channel List.....	16
Safety Precautions	3	Moving a Channel.....	16
Power Source	3	Deleting a Channel	16
Power Cord.....	3	Renaming a Channel.....	16
Moisture and Water	4	Locking a Channel.....	16
Cleaning.....	4	Managing Stations: Favourites.....	16
Heat and Flames	4	Button Functions.....	16
Lightning	4	Managing Stations: Sorting Channel List	17
Replacement Parts	4	On-Screen Information	17
Servicing.....	4	Media Playback Using Media Browser.....	17
Waste Disposal.....	4	Viewing Photos via USB.....	18
Information for Users in European Union		Media Browser Settings.....	18
Countries	4	Changing Image Size: Picture Formats.....	19
Disconnecting the Device	4	Configuring Picture Settings.....	20
Headphone Volume	4	Operating Picture Settings Menu Items.....	20
Installation.....	4	Picture Settings Menu Items.....	20
LCD Screen	4	PC Picture Settings.....	20
Warning	5	Configuring Sound Settings.....	21
Package Contents	5	Operating Sound Settings Menu Items.....	21
Environmental Information.....	6	Sound Settings Menu Items.....	21
Remote Control Buttons	7	Configuring Your TV's Settings.....	21
LCD TV and Operating Buttons.....	8	Operating Settings Menu Items	21
Viewing the Back side Connections	8	Settings Menu Items	21
Viewing the Connections - Side Connectors	9	Using a Conditional Access Module	22
Power Connection	10	Viewing Conditional Access Menu (*).....	22
Aerial Connection	10	Configuring Language Preferences.....	22
Using Digital Multimedia Connectors.....	10	Parental Control.....	23
USB Memory Connection	10	Parental Settings Menu Operation	23
Connecting the LCD TV to a PC.....	10	Timers.....	23
Using Side AV Connectors	10	Setting Sleep Timer	23
Connecting to a DVD Player via HDMI.....	11	Setting Programme Timers.....	23
Connecting to a DVD Player via Component		Adding a Timer.....	23
Sockets (YPbPr) or Scart Cable	11	Editing a Timer.....	23
Remote Control Handset.....	11	Deleting a Timer.....	23
Inserting Batteries.....	11	Configuring Date/Time Settings.....	24
Switching On/Off.....	12	Configuring Source Settings.....	24
To Switch the TV On.....	12	Configuring Other Settings	24
To Switch the TV Off	12	Operation.....	24
Input Selection.....	12	Other Features	25
Basic Operations	12	Analogue Teletext	25
Operation with the Buttons on the TV.....	12	Tips.....	26
Volume Setting.....	12	Appendix A: PC Input Typical Display Modes.....	27
Programme Selection	12	Appendix B: AV and HDMI Signal Compatibility	
AV Mode	12	(Input Signal Types).....	27
Operation with the Remote Control	12	Appendix C: Supported DVI Resolutions.....	28
Volume Setting.....	12	Appendix D: Supported File Formats for USB	
Programme Selection (Previous or Next		Mode.....	28
Programme).....	12	Appendix E: Pin Specifications.....	29
Programme Selection (Direct Access).....	12	SCART connector pin specifications	29
Viewing Electronic Programme Guide (EPG).....	13	HDMI connector pin specifications	29
First Time Installation.....	14	Signal Input.....	29
Installation	14	PC RGB Terminal (D-sub 15-pin connector).....	29
Auto Channel Scan Menu Operation.....	15	Appendix F: Software Upgrade	30
Manual Tuning	15	Specifications	31
Digital Manual Search.....	15	DVB-T functionality information.....	32
Analogue Manual Search	15	Product Guarantee	33

Features

- Remote controlled colour LCD TV.
- Fully integrated Terrestrial digital TV (DVB-T - MPEG2)
- HDMI connector for digital video and audio. This connection is also designed to accept high definition signals.
- USB input.
- 1000 programmes (analogue+digital).
- OSD menu system.
- Integrated tuner MPEG 2 compatible.
- Scart socket for external devices (such as video, video games, audio set, etc.).
- Stereo sound system. (German+Nicam)
- Teletext, fastext, TOP text.
- Headphone connection.
- Automatic programming system.
- Forward or backward manual tuning.
- Sleep timer.
- Automatic sound mute when no transmission.
- NTSC playback.
- AVL (Automatic Volume Limiting).
- Auto power down.
- PLL (Frequency Search).
- PC input.
- Plug&Play for Windows 98, ME, 2000, XP, Vista, Windows 7.
- Game Mode
- LED backlight

Introduction

Please read the corresponding instructions of this handbook prior to the first usage of the device, even when the usage of electronic devices is familiar to you. Notice especially the chapter SAFETY PRECAUTIONS. Carefully keep the handbook as future reference. When selling the device or giving it away, absolutely give these direction for use.

Thank you for choosing this product. This manual will guide you for the proper operation of your TV. Before operating the TV, please read this manual thoroughly. Please do keep this manual in a safe place for future references.



This device is intended to receive and display TV programs. The different connection options make an additional expansion of the reception and display sources possible (receiver, DVD player, DVD recorder,

VCR, PC etc.). This device is only suitable for the operation in dry interiors. This appliance is intended solely for private domestic use and may not be used for industrial and commercial purposes. We exclude liability in principle, if the device is not used as intended, or unauthorized modifications have been made. To operate your LCD TV in extreme ambient conditions may cause the damage of the device.

Preparation

For ventilation, leave a free space of at least 10 cm all around the set. To prevent any fault and unsafe situations, please do not place any objects on top of the set. Use this device in moderate climates.

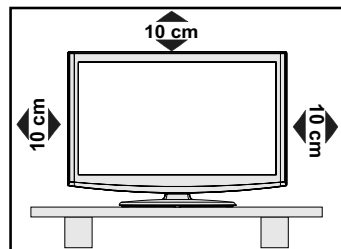

Safety Precautions

Please read the following recommended safety precautions carefully for your safety.

SOME DOS AND DON'TS ON THE SAFE USE OF EQUIPMENT

This equipment has been designed and manufactured to meet international safety standards but, like any electrical equipment, care must be taken if you are to obtain the best results and safety is to be assured.

DO read the operating instructions before you attempt to use the equipment.

DO ensure that all electrical connections (including the mains plug, extension leads and inter-connections between the pieces of equipment) are properly made and in accordance with the manufacturer's instructions. Switch off and withdraw the mains plug before making or changing connections.

DO consult your dealer if you are ever in doubt about the installation, operation or safety of your equipment.

DO be careful with glass panels or doors on equipment.

DO route the mains lead so that it is not likely to be walked on, crushed, chafed, or subjected to excessive wear and tear or heat.

DON'T remove any fixed cover as this may expose dangerous voltages.

DON'T obstruct the ventilation openings of the equipment with items such as newspapers, tablecloths, curtains, etc. Overheating will cause damage and shorten the life of the equipment.

DON'T allow electrical equipment to be exposed to dripping or splashing, or objects filled with liquids, such as vases, to be placed on the equipment.

DON'T place hot objects or naked flame sources such as lighted candles or nightlights on, or close to equipment. High temperatures can melt plastic and lead to fires.

DON'T use makeshift stands and **NEVER** fix legs with wood screws - to ensure

complete safety always fit the manufacturer's approved stand or legs with the fixings provided according to the instructions.

DON'T use equipment such as personal stereos or radios so that you are distracted from the requirements of traffic safety. It is illegal to watch television whilst driving.

DON'T listen to headphones at high volume, as such use can permanently damage your

hearing.

DON'T leave equipment switched on when it is unattended unless it is specifically stated

that it is designed for unattended operation or has a stand-by mode. Switch off using the

switch on the equipment and make sure that your family know how to do this. Special

arrangements may need to be made for infirm or handicapped people.

DON'T continue to operate the equipment if you are in any doubt about it working

normally, or if it is damaged in any way - switch off, withdraw the mains plug and consult

your dealer.

ABOVE ALL

--- NEVER let anyone especially children push anything into holes, slots or any other opening in the case - this could result in a fatal electrical shock;

--- NEVER guess or take chances with electrical equipment of any kind

--- it is better to be safe than sorry!

Power Source



The TV set should be operated only from a 220-240 V AC, 50 Hz outlet. Ensure that you select the correct voltage setting for your convenience.

Power Cord

Do not place the set, a piece of furniture, etc. on the power cord (mains lead) or pinch the cord. Handle the power cord by the plug. Do not unplug the appliance by pulling from the power cord and never touch the power cord with wet hands as this could cause a short circuit or electric shock. Never make a knot in the cord or tie it with other cords. The power cords should be placed in such a way that they are not likely to be stepped on. A damaged power cord can cause fire or give you an electric shock. When it is damaged and needs to be replaced, it should be done by qualified personnel.

This TV receiver is supplied with a moulded mains plug. The mains plug must not be cut off, as it may contain a special radio interference filter, the removal of which could lead to impaired performance. If you wish to extend the lead, obtain an appropriate safety approved extension lead or consult your dealer.

Observe the manufacturers instructions when connecting extension leads to the set. Check the fuse rating on the new plug; this should be fitted with a 5 Amp fuse which conforms to either ASTA or BSI (BS1362) approvals, these are easily identifiable by

either the  or  symbols. If you are in any doubt about the installation of an extension lead, please consult a competent electrician.

Moisture and Water

Do not use this device in a humid and damp place (avoid the bathroom, the sink in the kitchen, and near the washing machine). Do not expose this device to rain or water, as this may be dangerous and do not place objects filled with liquids, such as flower vases, on top. Avoid from dripping or splashing.



If any solid object or liquid falls into the cabinet, unplug the TV and have it checked by qualified personnel before operating it any further.

Cleaning

Before cleaning, unplug the TV set from the wall outlet. Do not use liquid or aerosol cleaners. Use soft and dry cloth.



Ventilation

The slots and openings on the TV set are intended for ventilation and to ensure reliable operation. To prevent overheating, these openings must not be blocked or covered in anyway.

Heat and Flames

The set should not be placed near to open flames and sources of intense heat such as an electric heater. Ensure that no open flame sources, such as lighted candles, are placed on top of the TV. Batteries should not be exposed to excessive heat such as sunshine, fire or the like.



Lightning

Before a storm and lightning or when going on holiday, disconnect the power cord from the wall outlet.



Replacement Parts

When replacement parts are required, make sure that the service technician has used replacement parts, which are specified by the manufacturer or have the same specifications as the original one. Unauthorized substitutions may result in fire, electrical shock or other hazards.

Servicing

Please refer all servicing to qualified personnel. Do not remove the cover yourself as this may result in an electric shock.



Waste Disposal

- Instructions for waste disposal:
- Packaging and packaging aids are recyclable and should principally be recycled. Packaging materials, such as foil bag, must be kept away from children.
- Batteries, including those which are heavy metal-free, should not be disposed of with household waste. Please dispose of used battery in an environment friendly manner. Find out about the legal regulations which apply in your area. Don't try to recharge batteries. Danger of explosion. Replace batteries only with the same or equivalent type.

Information for Users in European Union Countries

The above mark is in compliance with the Waste Electrical and Electronic Equipment Directive 2002/96/EC (WEEE). The mark indicates the requirement NOT to dispose the equipment including any spent or discarded batteries as unsorted municipal waste, but use the return and collection systems available. If the batteries or accumulators included with this equipment display the chemical symbol Hg, Cd, or Pb, then it means that the battery has a heavy metal content of more than 0.0005% Mercury, or more than 0.002% Cadmium or more than 0.004% Lead.



Disconnecting the Device

The mains plug is used to disconnect TV set from the mains and therefore it must remain readily operable.

Headphone Volume

Excessive sound pressure from earphones and headphones can cause hearing loss.



Installation

To prevent injury, this device must be securely attached to the wall in accordance with the installation instructions when mounted to the wall (if the option is available).

LCD Screen

The LCD panel is a very high technology product with about a million thin film transistors, giving you fine picture details. Occasionally, a few non-active pixels may appear on the screen as a fixed blue, green or red point. Please note that this does not affect the performance of your product.

Warning

Do not leave your TV in standby or operating mode when you leave your house.



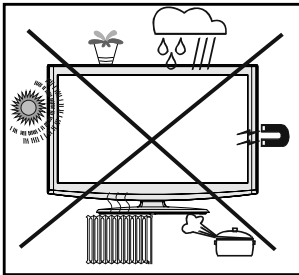

- The Standby / On button doesn't separate this device completely from mains. Moreover the device consumes power in the standby operation. In order to separate the device completely from mains, the mains plug has to be pulled from the mains socket. Because of that the device should be set up in a way, that an unobstructed access to mains socket is guaranteed, so that in case of emergency the mains plug can be pulled immediately. To exclude the danger of fire, the mains plug should be removed from the mains socket prior to a longer period of non-usage, i.e. during vacations.

Electrical device not in the hands of children

Never let children use electrical device unsupervised. Children can't always recognize properly the possible dangers. Batteries / accumulators can be life threatening when swallowed. Store batteries unreachable for small children. In case of swallowing a battery medical aid has to be sought immediately. Also keep the packaging foils away from children. There is danger of suffocation.

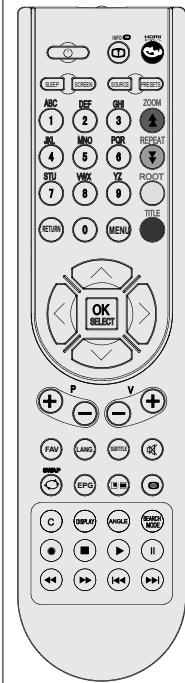
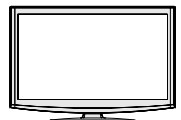
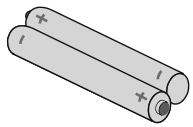

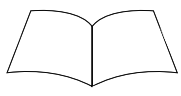
Package Contents

	 LCD TV
	 Batteries: 2 X AAA
	 Quick Guide
	 Instruction Book
	 Digital Tuning Guide
	 1 X Video & Audio Connection Cable
	 1 X Component Video Connection Cable

Note: You should check the accessories after purchasing. Make sure that each accessory is included.

Environmental Information

- This television has been designed to be environmentally friendly by consuming less energy.

You will not only help to save the environment but you can also save money by reducing electricity bills thanks to the energy efficiency feature of this TV. To reduce energy consumption, you should take the following steps:

- You can use Power Save Mode setting, located in the Feature menu. If you set Power Save Mode to On, the TV will switch to energy-saving mode and brightness level of TV set will be set to the optimum level for home viewing.

Note that some picture settings will be unavailable to be changed when the TV is in Power Save Mode.

Power Save Mode

On

- When the TV is not in use, please switch off or remove the mains plug from the wall socket. This will also reduce energy consumption.
- Also remove the mains plug from the wall socket when you are away from home for long period of time.
- Please help us to save the environment by following these steps.

Remote Control Buttons

1. Standby
2. Image size/ Expand (in TXT mode)
3. Sleep timer
4. Numeric buttons
5. Return / Exit (in DTV mode) / Index page (in TXT mode)
6. Cursor up / Page up (in TXT mode)
7. Cursor left
8. Programme up (Page down in DTV mode)
9. Programme down (Page up in DTV mode)
10. Mono-Stereo / Dual I-II / Current language
11. Previous Programme / Swap
12. Electronic programme guide
13. Info / Reveal (in TXT mode)
14. Picture mode selection
15. Source selection
16. Red button / Zooms videos (in Media Browser video mode)
17. Green button
18. Yellow button
19. Menu on-off
20. Blue button
21. OK / Edit Channel list / Hold (in TXT mode)
22. Cursor right / Subpage (in TXT mode)
23. Cursor down / Page down (in TXT mode)
24. Volume up
25. Volume down
26. Mute
27. Teletext / Mix
28. Subtitle on-off (in DTV mode) / TXT Subtitle
29. FAV (*) (Favourite Selection) (in DTV mode)
30. No Function
31. Media Browser playback buttons. (in DTV mode)

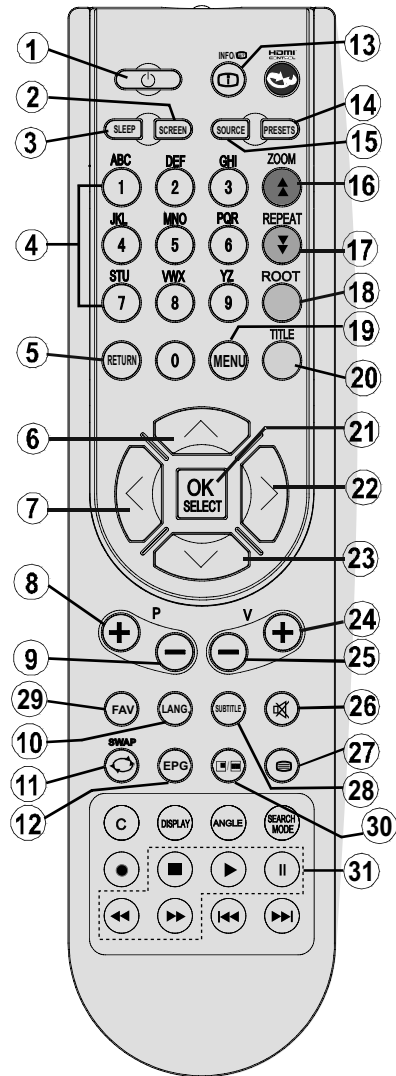

(*) Only for EU country options.

Note: Buttons that are not indicated with a number on the remote control illustration are not functional in TV mode.



: No function

LCD TV and Operating Buttons

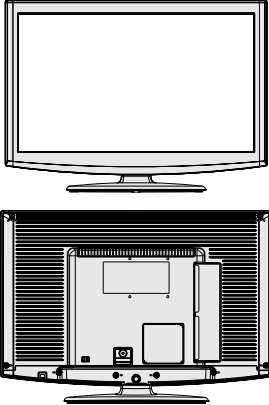
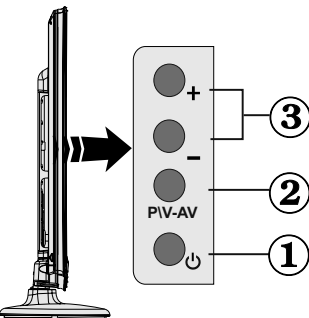
FRONT and REAR VIEW	Control buttons VIEW	Control Buttons
		<p>1. Standby Off/On button 2. TV/AV button 3. Programme Up/Down buttons- Volume Up/Down buttons</p> <p>Note: You can use +/- buttons to change volume. If you want to change channels, press P/V/AV button once and then use +/- buttons. If you hold the P/V/AV button about a few seconds, source OSD will be displayed. Main menu OSD cannot be displayed via control buttons.</p>

Viewing the Back side Connections

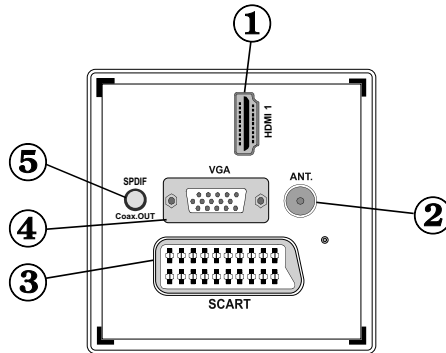

1. HDMI 1: HDMI Input

HDMI Input are for connecting a device that has an **HDMI** socket. Your LCD TV is capable of displaying High Definition pictures from devices such as a High Definition Satellite Receiver or DVD Player. These devices must be connected via the HDMI sockets or Component Socket. These sockets can accept either 720p or 1080p signals. No sound connection is needed for an HDMI to HDMI connection.

2. RF Input connects to an aerial antenna system.

Note that if you use a decoder or a media recorder, you should connect the aerial cable through the device to the television with an appropriate antenna cable, as shown in the illustration in the following pages.

3. SCART input or output for external devices. Connect the SCART cable between SCART socket on TV and SCART socket on your external device (such as a decoder, a VCR or a DVD player).

Note: If an external device is connected via the SCART socket, the TV will automatically switch to AV mode.

Note: S-VHS signal is supported via the scart socket.

4. PC Input is for connecting a personal computer to the TV set.

Connect the PC cable between the **PC INPUT** on the TV and the PC output on your PC.

5. S/PDIF Coaxial Out outputs digital audio signals of the currently watched source.

Use an **SPDIF coaxial cable** to transfer audio signals to a device that has S/PDIF input (not supplied).

Viewing the Connections - Side Connectors

1. CI Slot is used for inserting a CI card. A CI card allows you to view subscription channels. For more information, see “Conditional Access” section.
2. Side USB input.
3. TV control buttons.
4. **Component Video Input (YPbPr)** is used for connecting component video. You can connect the component video and audio sockets with a device that has component output. To do this, you must use the supplied component video connection cable for enabling connection. First, plug single jack of the cable to the TV's YPbPr socket (side). Afterwards, insert your component cable's (not supplied) connectors into the plural part of the Component video connection cable. Colours of the connected jacks should match.
5. **Side audio-video connection** input is used for connecting video and audio signals of external devices. To make a video connection, you must use the supplied AV connection cable for enabling connection. First, plug singular jack of the cable to the TV's Side AV socket. Afterwards, insert your video cable's (not supplied) connector into the YELLOW input (located on the plural side) of the supplied AV connection cable. Colours of the connected jacks should match.

To enable audio connection, you must use RED and WHITE inputs of the side AV connection cable. Afterwards, insert your device's audio cable's connectors into the RED and WHITE jack of the **supplied** side AV connection cable. Colours of the connected jacks should match.

Note: You should use audio inputs of side AV connection cable (RED & WHITE) to enable sound connection when connecting a device to your TV by using PC or COMPONENT VIDEO input.

6. Headphone jack is used for connecting an external headphone to the system. Connect to the HEADPHONE jack to listen to the TV from headphones (optional).

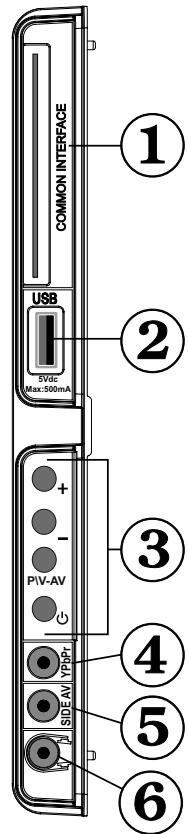

Power Connection

IMPORTANT: The TV set is designed to operate on 220-240V AC, 50 Hz.

- After unpacking, allow the TV set to reach the ambient room temperature before you connect the set to the mains. Plug the power cable to the mains socket outlet.

Aerial Connection

- Connect the aerial cable TV plug to the AERIAL INPUT socket located at the rear of the TV.

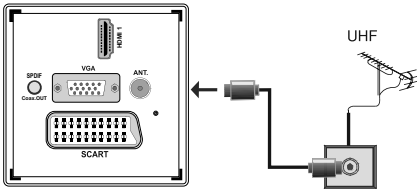

Using Digital Multimedia Connectors

- You can connect USB devices to your TV by using the USB input of the TV. This feature allows you to display/play JPG, MP3 and video files stored in a USB stick.
- It is possible that certain types of USB devices (e.g. MP3 Players) may not be compatible with this TV.
- You should back up your files before making any connections to the TV set in order to avoid any possible data loss. Note that manufacturer will not be responsible for any file damage or data loss.
- Do not pull out USB module while playing a file.

CAUTION: Quickly plugging and unplugging USB devices, is a very hazardous operation. Especially, do not repeatedly quickly plug and unplug the drive. This may cause physical damage to the USB player and especially the USB device itself.

SIDE VIEW USB MEMORY

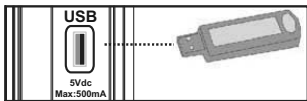

USB Memory Connection

IMPORTANT: The TV should be switched off while plugging or unplugging a USB device. Plug your USB devices to the USB input of the TV. You can connect a usb device to your TV by using the USB input of the TV.

Note: It is possible certain types of hard disk drives are not supported.

Connecting the LCD TV to a PC

For displaying your computer's screen image on your LCD TV, you can connect your computer to the TV set. Power off both computer and display before making any connections. Use 15-pin D-sub display cable to connect a PC to the LCD TV. When the connection is made, switch to PC source. See "Input selection" section. Set the resolution that suits your viewing requirements. Resolution information can be found in the appendix parts.

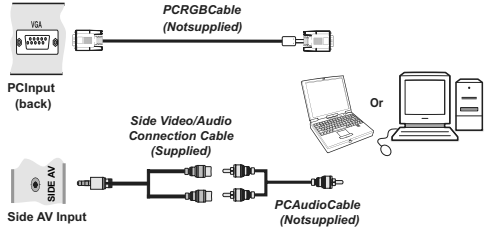

Note. refer to item 5 on page 8.

Using Side AV Connectors

You can connect a range of optional equipment to your LCD TV using side connectors of the TV.

- For connecting a camcorder or camera, you should use **AV** socket (side). To do this, you must use the supplied **video/audio connection cable**. First, plug single jack of the cable to the TV's **AV IN** socket (side). Afterwards, insert your camera cable's (*not supplied*) connectors into the plural part of the **video/audio connection cable**. Colours of the connected jacks should match. See illustration below.
- Afterwards, you should switch to **Side AV** source. See the section **Input selection** in the following sections for more information.

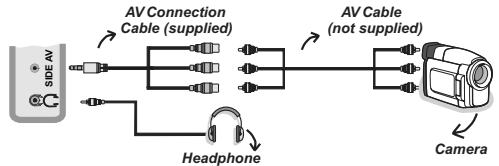

- To listen the TV sound from headphones, you should connect headphones to your TV by using the **HEADPHONE** jack as illustrated above.

Connecting to a DVD Player via HDMI

Please refer to your DVD player's instruction book for additional information. Power off both the TV and the device before making any connections.

Note: Not all cables shown in the illustration are supplied.

- If your DVD player has an **HDMI** socket, you can connect via **HDMI** for better video and audio quality.

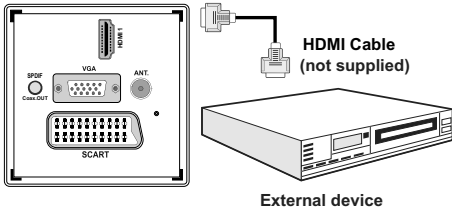

- When you connect to DVD player as illustrated above, switch to the connected **HDMI** source. See, **Input Selection** section for more information on changing sources.

Connecting to a DVD Player via Component Sockets (YPbPr) or Scart Cable

- Some DVD players are connected through **COMPONENT SOCKETS (YPbPr)**. In this case, you must use the supplied Component video connection cable for enabling connection. First, plug single jack of the cable to the TV's YPbPr socket (side). Afterwards, insert your component cable's (not supplied) connectors into the plural part of the Component video connection cable (see illustration below). Colours of the connected jacks should match.

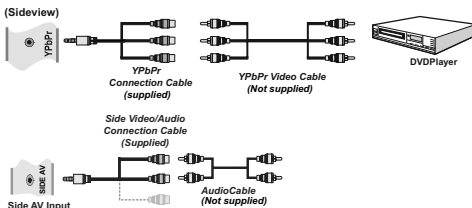

- To enable audio connection, use the supplied Video & Audio Connection Cable. First, plug the single jack of the cable to the TV's SIDE AV input. Afterwards, insert your DVD player's audio cable's connectors into the RED and WHITE parts of the Video & Audio Connection Cable. Colours of the connected jacks should match.
- When the connection is made, switch to YPbPr source. See, Input Selection section.

Note: To connect Y Pb Pr device, you should use supplied component (YPbPr) connection cable

- You may also connect through the **SCART** input.

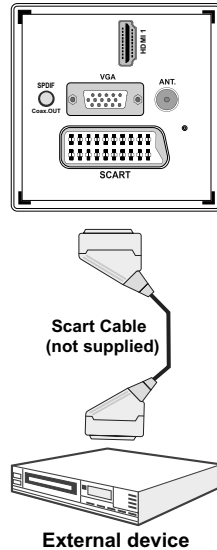

- **Note:** These three methods of connection perform the same function but in different levels of quality. It is not necessary to connect by all three methods.

Remote Control Handset

Inserting Batteries

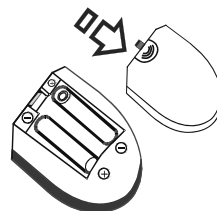

- Remove the battery cover located on the back of the handset by gently pulling backwards from the indicated part.
- Insert two **AAA/R3** or equivalent type batteries inside. Observe the correct polarity (+/-) when inserting batteries and replace the battery cover.



Note: Remove the battery from remote control handset when it is not to be used for a long period. Otherwise it can be damaged due to any leakage of batteries. Remote range is approximately 7m/23ft.

Switching On/Off



To Switch the TV On

- Connect the power cord to the 220-240V AC 50 Hz. Then the red standby LED lights up.(at first, the red and blue leds will flash alternately)
- To switch on the TV from standby mode either:
- Press the “” button, **P+ / P-** or a numeric button on the remote control.
- Press the “” button, - or + button on the TV. The TV will then switch on.

Note: If you switch on your TV via PROGRAMME UP/DOWN buttons on the remote control or on the TV set, the programme that you were watching last will be reselected.

By either method the TV will switch on.

To Switch the TV Off

- Press the “” button on the remote control or press the “” switch on the TV, so the TV will switch to standby mode.
- **To power down the TV completely, unplug the power cord from the mains socket.**

Note: When the TV is switched to standby mode, standby LED can blink to indicate that features such as Standby Search, Over Air Download or Timer is active.

Input Selection

Once you have connected external systems to your TV, you can switch to different input sources. Press “**SOURCE**” button on your remote control consecutively for directly changing sources.



Basic Operations

You can operate your TV using both the remote control and onset buttons.

Operation with the Buttons on the TV

Main menu OSD cannot be displayed via control buttons. “+/-” buttons will function as volume up/down as default. Even if you set other functions for these buttons, “+/-” buttons will perform as default after a short while.

Volume Setting

- Press “**PV/AV**” button twice and then use “+/-” buttons to increase or decrease volume, so a volume level scale (slider) will be displayed on the screen. While Tv is on, +/- button can use as volume + or volume - as default.

Programme Selection

- Press “**PV/AV**” button once and then use “+/-” buttons to change channel. By pressing “+/-” button,you can select the next or previous programme.

AV Mode

- Hold the “**PV/AV**” button, source OSD will be displayed in a few second.

Operation with the Remote Control

- The remote control of your TV is designed to control all the functions of the model you selected. The functions will be described in accordance with the menu system of your TV.

Volume Setting

- Press “**V+**” button to increase the volume. Press “**V-**” button to decrease the volume. A volume level scale (slider) will be displayed on the screen.

Programme Selection (Previous or Next Programme)

- Press “**P -**” button to select the previous programme.
- Press “**P +**” button to select the next programme.

Programme Selection (Direct Access)

- Press numeric buttons on the remote control to select programmes between 0 and 9. The TV will switch to the selected programme. To select programmes between, press the numeric buttons consecutively. When the pressing time is due for the second numeric button, only the first digit programme will be displayed. Press directly the programme number to reselect single digit programmes.

Viewing Electronic Programme Guide (EPG)

You can view the electronic programme guide (EPG) to view information about available programmes. To view the EPG menu please press GUIDE button on the remote control.

- Press “▼/▲” buttons to navigate through channels.
- Press “◀/▶” buttons to navigate through the programme list.
- EPG menu displays available information on all channels.
- Please note that event information is updated automatically. If there are no event information data available for channels, EPG will be displayed with blanks.



OK (Options): Displays programme options including “**Select Channel**” option.

INFO (Event Details): Displays the programmes in detail.

Green button: Programme schedule will be listed

Yellow button: Display EPG data in accordance with timeline schedule

Blue button (Filter): Views filtering options.



Red button (Prev Time Slice): Displays the programmes of previous time slice.

Green button (Next Time Slice): Displays the programmes of the next time slice.

Yellow button (Prev Day): Displays the programmes of previous day.

Blue button (Next day): Displays the programmes of the next day.

Numeric buttons (Jump): Jumps to the preferred channel directly via numeric buttons.

OK (Options): Displays programme options including “**Select Channel**” option.

Text button (Filter): Views filtering options.

INFO (Details): Displays the programmes in detail.



Red button (Prev Day): Displays the programmes of previous day.

Green button (Next day): Displays the programmes of the next day.

Yellow button (Zoom): Expands programme information.

Blue button (Filter): Views filtering options.

INFO (Details): Displays the programmes in detail.

Numeric buttons (Jump): Jumps to the preferred channel directly via numeric buttons.

OK (Options): Displays programme options including “**Select Channel**” option.

Text (Search): Displays “**Guide Search**” menu.

SUBTTL: Press **SUBTITLE** button to view Select Genre menu. Using this feature, you can search the programme guide database in accordance with the genre. Info available in the programme guide will be searched and results matching your criteria will be listed.

(Now) : Shows the current programme.

First Time Installation

IMPORTANT: Ensure that the aerial is connected before switching on the TV for the first time installation.

- When the TV is operated for the first time, installation wizard will guide you through the process. First, language selection screen will be displayed:



- Use “▼” or “▲” buttons to select your language and press **OK** button to set selected language and continue.
- After selecting the language, “Welcome!” screen will be displayed, requiring you to set **Country**, **Teletext Language** and **Scan Encrypted** options.



- By pressing “◀” or “▶” button, select the **country** you want to set and press “▼” button to highlight **Teletext Language** option. Use “◀” or “▶” button to select desired Teletext Language.
- Press “▼” button after setting Teletext Language option. **Scan Encrypted** will be then highlighted. You can set **Scan Encrypted** as **Yes** if you want to scan coded stations. Afterwards select the desired Teletext Language.
- Press **OK** button on the remote control to continue and the following message will be displayed on the screen:

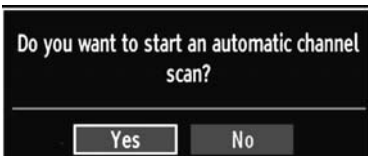

To select the “Yes” or “No” option, highlight the item by using “◀” or “▶” buttons and press **OK** button.

Afterwards, the following OSD will be displayed on the screen and the digital television will search for digital terrestrial TV broadcasts.



*Note: You can press **MENU** button to cancel.*

- After all the available stations are stored, Channel List will be displayed on the screen. If you like the sort channels, according to the LCN, please select “Yes” and than press “OK”.



- Press **OK** button to quit channel list and watch TV.

Installation

Press **MENU** button on the remote control and select **Installation** by using “◀” or “▶” button. Press **OK** button and the following menu screen will be displayed.

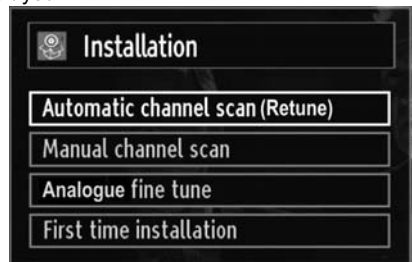

Select **Automatic Channel Scan** by using “▼”/“▲” button and press **OK** button. **Automatic Channel Scan** options will be displayed. You can select **Digital**, **Analogue** or **Digital tuning** using “▼”/“▲” and **OK** buttons.

Auto Channel Scan Menu Operation

Digital: Searches and stores DVB stations.

Analogue: Searches and stores analogue stations.

Full: Searches and stores both analogue and DVB stations.

- Whenever you select an automatic search type and press **OK** button, a confirmation screen will appear on the screen. To start installation process, select **Yes**, to cancel select **No** by using “◀” or “▶” and **OK** button.
- After auto channel scan type is set and selected and confirmed, installation process will start and progress bar will move along. Press **MENU** button to cancel process. In such a case, located channels are not stored.

Manual Tuning

HINT: This feature can be used for direct broadcast entry.

- Select **Manual Channel Scan** from the Installation menu by using “▼”/“▲” and **OK** buttons. Manual Scan options screen will be displayed.
- Select the desired **Search Type** using “◀” or “▶” button. Manual search options will change accordingly. Use “▼”/“▲” button to highlight an item and then press “◀” or “▶” button to set an option. You can press **MENU** button to cancel.

Digital Manual Search



In manual channel scan, the number of the multiplex or frequency are entered manually and only that multiplex or frequency are searched for the channels. After selecting search type as **Digital**, you can enter the multiplex or frequency number using the numeric buttons and press **OK** button to search.

Analogue Manual Search



After selecting search type as analogue, you can use “▼”/“▲” button to highlight an item and then press “◀” or “▶” button to set an option.

Enter the channel number or frequency using the numeric buttons. You can then press **OK** button to search. When the channel is located, any new channels that are not on the list will be stored.

Analogue Fine Tune

- Select **Analogue Fine Tune** from the Installation menu by using “◀” or “▶” and **OK** buttons. Analogue fine tune screen will be displayed. Analogue Fine Tune feature will not be available if there are no analogue channels, digital channels and external sources stored.
- Press **OK** button to proceed. Use “◀” or “▶” button to set Fine Tune. When finished, press **OK** button again.

Managing Stations: Channel List

The TV sorts all stored stations in the Channel List. You can edit this channel list, set favourites or set active stations to be listed by using the Channel List options.

- Press **MENU** button to view main menu. Select Channel List item by using “◀” or “▶” button. Press **OK** to view menu contents.



Select **Edit Channel List** to manage all stored channels. Use “◀” or “▶” and **OK** buttons to select Edit Channel List.

Operating the Channel List



- Press “▼” or “▲” button to select the channel that will be processed. Press “◀” or “▶” button to select a function on Channel List menu.
- Use **P+/P-** buttons to move page up or down.
- Press **BLUE** button to view filtering options.
- Press **MENU** button to exit.

Moving a Channel

- First select the desired channel. Select Move option in the channel list and press **OK** button.
- Edit Number screen will be displayed. Enter the desired channel number by using the numeric buttons on the remote control. If there is a previously stored channel on that number, a warning screen will be displayed. Select Yes if you want to move the channel and press **OK**.
- Press **OK** button to process. Selected channel is now moved.

Deleting a Channel

You can press **GREEN** button to tag/untag all channels; **YELLOW** button to tag/untag channel.

- Select the channel that you want to delete and select **Delete** option. Press **OK** button to continue.
- A warning screen will appear. Select **YES** to delete, select **No** to cancel. Press **OK** button to continue.

Renaming a Channel

- Select the channel that you want to rename and select **Edit Name** option. Press **OK** button to continue.
- Pressing “◀” or “▶” button moves to the previous/next character. Pressing “▼” or “▲” button toggles the current character, i.e., ‘b’ character becomes ‘a’ by “▼” and ‘c’ by “▲”. Pressing the numeric buttons ‘0...9’ replaces the highlighted character with the characters printed above the button one by one as the button is pressed.
- When finished, press **OK** button to save. Press **MENU** to cancel.

Locking a Channel

You can press **GREEN** button to tag/untag all channels; **YELLOW** button to tag/untag a single channel.

- Select the channel that you want to lock and select **Lock** option. Press **OK** button to continue.
- You will be asked to enter parental control PIN. Default PIN is set as **0000**. Enter the PIN number.



- Press **OK** button when the desired channel is highlighted to lock/unlock the channel. Lock symbol will be displayed next to the selected channel.

Managing Stations: Favourites

You can create a list of favourite programmes.

- Press **MENU** button to view main menu. Select Channel List item by using “◀” or “▶” button. Press **OK** to view menu contents.
- Select **Favourites** to manage favourite list. Use “▼”/“▲” and **OK** buttons to select **Favourites**.
- You can set various channels as favourites so that only the favourite channels are navigated.



- Select a channel by using “▼” or “▲” button. Press **OK** button to add selected channel to favourites list. Press **OK** button again to remove.

Button Functions

- **OK**: Add/remove a station.
- **YELLOW**: Tag/untag a channel.
- **GREEN**: Tag/untag all channels.
- **BLUE**: Displays filtering options.

Managing Stations: Sorting Channel List

You can select broadcasts to be listed in the channel list. To display specific types of broadcast, you should use Active channel list setting.

Select Active channel list from the Channel list menu by using “◀” or “▶” button. Press **OK** button to continue.



You can select a broadcast type option from the list by using “▼” / “▲” and **OK** buttons.

Show All = showing all channels in the list.

Digital Only = change channels between digital channels.

Analogue TV Only = change channels between only analogue channels.

TV Only = change channels between Digital and Analogue channels.

Radio Only = change channels between only radio channels.

Text Only = change channels between text channels especially in UK.

Favourites = change channels between selected favourite channels.

On-Screen Information

You can press **INFO** button to display on-screen information. Details of the station and current programme will be displayed on the information banner.

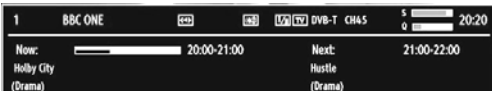

The information banner gives information on the channel selected and the programmes on it. The name of the channel is displayed, along with its channel list number. *Hint: Not all channels broadcast the programme data. If the name and time of the programme are not available, then information banner will be displayed with blanks.*

If the selected channel is locked, you must enter the correct four-digit numeric code to view the channel (default code is **0000**). “**Enter PIN**” will be displayed on the screen in such a case:

Media Playback Using Media Browser

If the USB stick is not recognized after power off/on or First Time Installation, first, plug the USB device out and power off/on the TV set. Plug the USB device in again.

To display Media Browser window, press either “**MENU**” button on the remote control and then select Media Browser by pressing “◀” or “▶” button. Press **OK** button to continue. Media Browser menu options will be displayed.

Also, when you plug USB devices, media browser screen will be displayed automatically:



You can play music, picture and video files from the connected USB memory stick. Use “◀” or “▶” button to select Videos, Photos, Music or Settings.

Viewing Videos via USB

Please refer to page 27 for supported formats



When you select Videos from the main options, available video files will be filtered and listed on this screen. You can use “▼” or “▲” button to select a video file and press **OK** button to play a video. If you select a subtitle file and press **OK** button, you can select or deselect that subtitle file. The following menu will be displayed while playing a video file:



Play (▶ button): Starts the video playback.
Stop (■ button): Stops the video playback.
Pause (⏸ button): Pause the video playback.
Rewind (◀◀ button): Goes backward.
Forward (▶▶ button): Goes forward.
Subtitle/Audio (LANG. button): Sets subtitle/Audio.
Yellow: Opens subtitle time correction menu



Press **RETURN (Exit)** button to switch back to previous menu.

Viewing Photos via USB

When you select Photos from the main options, available image files will be filtered and listed on this screen.



0...9 (Jump) (Numeric buttons): Jump to selected file using the numeric buttons.

OK: Views the selected picture in full screen.

Slideshow (▶ button): Starts the slideshow using all images.

GREEN button: Views images in thumbnails.

RED button: Sorts files by date.

YELLOW button: Toggles viewing style.

BLUE button: Changes media type.

Slideshow Options



Pause (⏸ button): Pauses the slideshow.

Continue (▶ button): Continues the slideshow.

Previous/Next (Left/Right buttons): Jumps to previous or next file on slideshow.

Rotate (Up/Down buttons): Rotates the image using up/down buttons.

Loop/Shuffle (GREEN button): Press once to disable Loop. Press again to disable both Loop and Shuffle. Press once more to enable only Shuffle. Press again to enable all. You can follow the disabled functions with the change of the icons.

RETURN: Back to file list.

INFO: Displays help screen.

Viewing Music via USB

When you select Music from the main options, available audio files will be filtered and listed on this screen.



0..9 (Numeric buttons): Jumps to the selected file.

Play This (OK button): Plays the selected file.

Play (▶ button): Plays all media files starting with the selected one.

Stop (■ button): Stops playback.

Pause (⏸ button): Pauses the selected playback.

Previous/Next (Left/Right buttons): Jumps to previous or next file to play.

FAV: Sorts files by Title, Artist or Album..

INFO: Changes filter options.

Loop/Shuffle (Blue button): Press once to disable Loop. Press again to disable both Loop and Shuffle. Press once more to enable only Shuffle. Press again to enable all. You can follow the disabled functions with the change of the icons.

Media Browser Settings



You can set your Media Browser preferences by using the Settings dialog. Press "▼" or "▲" button to highlight an item and use "◀" or "▶" button to set.

View Style: Sets default browsing mode.

Slide Show Interval: Sets slide show interval time.

Show Subtitle: Sets subtitle enabling preference.

Subtitle Language: Sets supported subtitle language.

Subtitle Position: Sets subtitle position as up or down.

Subtitle Font Size: Sets subtitle font size (max. 54pt).

Changing Image Size: Picture Formats

- Programmes can be watched in different picture formats, depending on the transmission received.
- You can change the aspect ratio (image size) of the TV for viewing the picture in different zoom modes.
- Press **SCREEN** button repeatedly to change the image size. Available zoom modes are listed below.

Auto

When a **WSS (Wide Screen Signalling)** signal, which shows the aspect ratio of the picture, is included in the broadcast signal or the signal from an external device, the TV automatically changes the **ZOOM** mode according to the **WSS** signal.

- When the **AUTO** mode does not function correctly due to poor **WSS** signal quality or when you want to change the **ZOOM** mode, change to another **ZOOM** mode manually.

16:9

This uniformly stretches the left and right sides of a normal picture (4:3 aspect ratio) to fill the wide TV screen.



- For 16:9 aspect ratio pictures that have been squeezed into a normal picture (4:3 aspect ratio), use the **16:9** mode to restore the picture to its original shape.

Subtitle

This zooms up the wide picture (16:9 aspect ratio) with subtitles to the full screen.

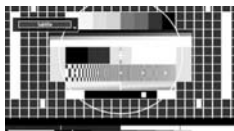

Note: You can shift to screen up or down by pressing “▼” / “▲” buttons while picture zoom is selected as panoramic, 14:9 Zoom, Cinema or Subtitle.

14:9

This zooms up the wide picture (14:9 aspect ratio) to the upper and lower limits of the screen.

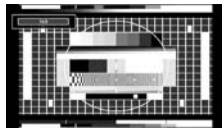

14:9 Zoom

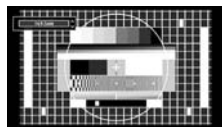

This option zooms to the 14:9 picture.

4:3

Use to view a normal picture (4:3 aspect ratio) as this is its original size.

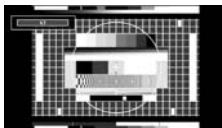

Panoramic

This stretches the left and right sides of a normal picture (4:3 aspect ratio) to fill the screen, without making the picture appear unnatural.

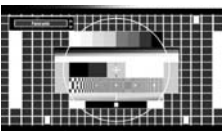

The top and bottom of the picture are slightly cut off.

Cinema

This zooms up the wide picture (16:9 aspect ratio) to the full screen.

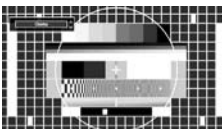

Configuring Picture Settings

You can use different picture settings in detail.

Press **MENU** button and select the Picture icon by using “◀” or “▶” button. Press **OK** button to view Picture Settings menu.

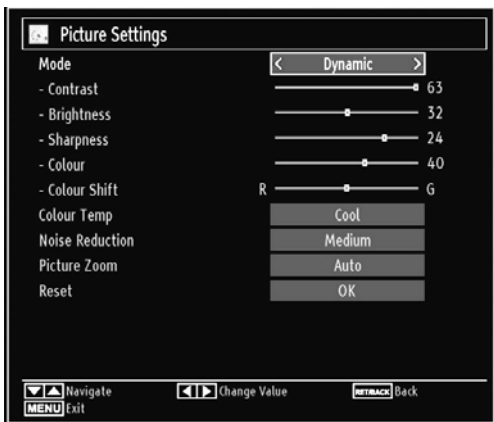

Operating Picture Settings Menu Items

- Press “▼” or “▲” button to highlight a menu item.
- Use “◀” or “▶” button to set an item.
- Press **MENU** button to exit.

Picture Settings Menu Items

Mode: For your viewing requirements, you can set the related mode option. Picture mode can be set to one of these options: **Cinema**, **Game**, **Dynamic** and **Natural**.

Contrast: Sets the lightness and darkness values of the screen.

Brightness: Sets the brightness value for the screen.

Sharpness: Sets the sharpness value for the objects displayed on the screen.

Colour: Sets the colour value, adjusting the colors.

Colour Shift: Adjust the desired colour tone.

Colour Temp: Sets the desired colour tone.

Setting **Cool** option gives white colours a slight blue stress.

For normal colours, select **Normal** option.

Setting **Warm** option gives white colours a slight red stress.

Noise Reduction: If the broadcast signal is weak and the picture is noisy, use **Noise Reduction** setting to reduce the noise amount. Noise Reduction can be set to one of these options: **Low**, **Medium**, **High** or **Off**.

Game Mode: When Game Mode is set to On, specific game mode settings, which are optimized for better video quality, will be loaded.

Note: When Game Mode is on, some items in the Picture Settings menu will be unavailable to be set.

Picture Zoom: Sets the picture size to Auto, 16:9, Subtitle, 14:9, 14:9 Zoom, 4:3, Panoramic or Cinema.

Reset: Resets the picture settings to factory default settings.

While in VGA (PC) mode, some items in Picture menu will be unavailable. Instead, VGA mode settings will be added to the Picture Settings while in PC mode.

PC Picture Settings

For adjusting PC picture items, do the following:

Press “◀” or “▶” button to select Picture icon. Picture menu appears on the screen.

Contrast, Brightness, Colour, Colour Temp and Picture Zoom settings in this menu are identical to settings defined in TV picture menu under “Main Menu System”.

Sound, Settings and Source settings are identical to the settings explained in main menu system.

PC Position: Select this to display PC position menu items.

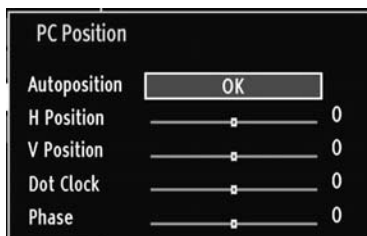

Autoposition: Automatically optimizes the display. Press **OK** to optimize.

H Position: This item shifts the image horizontally to right hand side or left hand side of the screen.

V Position: This item shifts the image vertically towards the top or bottom of the screen.

Dot Clock: Dot Clock adjustments correct the interference that appear as vertical banding in dot intensive presentations like spreadsheets or paragraphs or text in smaller fonts.

Phase: Depending on the resolution and scan frequency that you input to the TV set, you may see a hazy or noisy picture on the screen. In such a case you can use this item to get a clear picture by trial and error method.

Configuring Sound Settings

Sound settings can be configured according to your personal preferences.

Press **MENU** button and select the first icon by using “◀” or “▶” button. Press **OK** button to view Sound Settings menu.

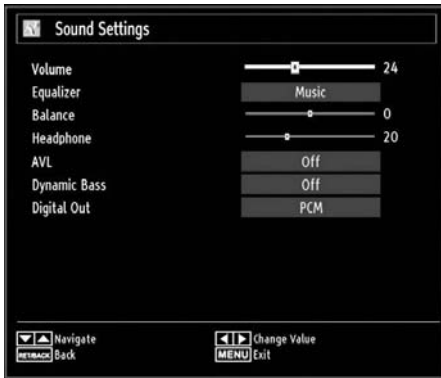

Operating Sound Settings Menu Items

- Press “▼” or “▲” button to highlight a menu item.
- Use “◀” or “▶” button to set an item.
- Press **MENU** button to exit.

Sound Settings Menu Items

Volume: Adjusts volume level.

Equalizer: Press **OK** button to view equalizer sub-menu.

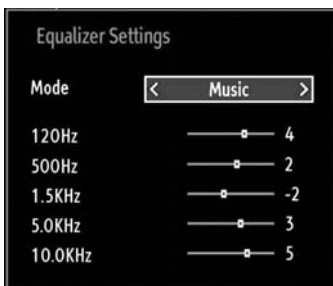

In equalizer menu, the preset can be changed to **Music**, **Movie**, **Speech**, **Flat**, **Classic** and **User**. Press the **MENU** button to return to the previous menu.

Note: Equalizer menu settings can be changed manually only when the **Equalizer Mode** is in **User**.

Balance: This setting is used for emphasizing left or right speaker balance.

Headphone: Sets headphone volume.

AVL: Automatic Volume Limiting (AVL) function sets the sound to obtain fixed output level between programmes

(For instance, volume level of advertisements tend to be louder than programmes).

Dynamic Bass: Dynamic Bass is used to increase bass effect of the TV set.

Digital Out: Sets digital out audio type.

Configuring Your TV's Settings

Detailed settings can be configured to suit your personal preferences.

Press **MENU** button and select Settings icon by using “◀” or “▶” button. Press **OK** button to view Settings menu.



Operating Settings Menu Items

- Press “▼” or “▲” button to highlight a menu item.
- Press **OK** button to select an item.
- Press **MENU** button to exit.

Settings Menu Items

Conditional Access: Controls conditional access modules when available.

Language: Configures language settings.

Parental: Configures parental settings.

Timers: Sets timers for selected programmes.

Date/Time: Sets date and time.

Sources: Enables or disables selected source options.

Other Settings: Displays other setting options of the TV set.

Using a Conditional Access Module

IMPORTANT: Insert or remove the CI module only when the TV is SWITCHED OFF.

- In order to watch certain digital channels, a conditional access module (CAM) can be necessary. This module must be inserted in the CI slot of your TV.
- Obtain the Conditional Access Module (CAM) and the viewing card by subscribing to a pay channel company, then insert those to the TV using the following procedure.
- Insert the CAM and then the viewing card to the slot that is located in the terminal cover at the rear side of the TV.
- The CAM should be correctly inserted, it is impossible to insert fully if reversed. The CAM or the TV terminal may be damaged if the CAM is forcefully inserted.

Connect the TV to the mains supply, switch on and then wait for few moments until the card is activated.

- When no module is inserted, “**No Common Interface module detected**” message appears on the screen.
- Refer to the module instruction manual for details of the settings.

Viewing Conditional Access Menu (*)

(*) These menu settings may change depending on the service provider.

Press **MENU** button and select the icon by using “◀” or “▶” button. Press **OK** button to view Settings menu. Use “▼” or “▲” button to highlight **Conditional Access** and press **OK** to view menu items.

Configuring Language Preferences

You can operate the TV's language settings using this menu.

Press **MENU** button and select the fifth icon by using “◀” or “▶” button. Press **OK** button to view Settings menu. Use “◀” or “▶” button to highlight **Language** and press **OK** to continue:

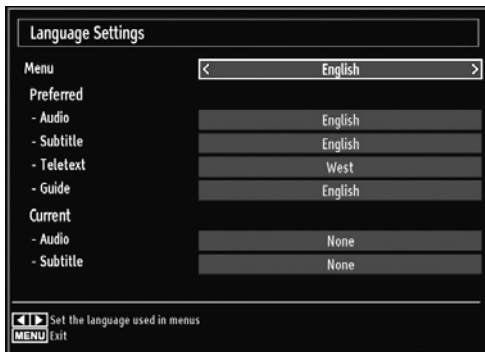

Use “▼” or “▲” button to set an item. Settings are stored automatically.

Menu: displays the system language.

Preferred

These settings will be used if available. Otherwise the current settings will be used.

- **Audio:** Sets the preferred audio language.
- **Subtitle:** Sets the subtitle language. Selected language will be seen in subtitles.
- **Teletext:** Sets teletext language.
- **Guide:** Sets the preferred Guide language.

Current (*)

(*) These settings can be changed if only the broadcaster supports. Otherwise, settings will not be available to be changed.

Audio: Changes the audio language for the current channel.

- **Subtitle:** Sets the subtitle language for the current channel.

Parental Control

This function enables or disables the menu protection system and allows the PIN code to be changed.

Press **MENU** button and select the icon by using “◀” or “▶” button. Press **OK** button to view Settings menu. Use “▼” or “▲” button to highlight **Parental** and press **OK** to continue:



To display parental lock menu options, PIN number should be entered. Factory default PIN number is **0000**. After coding the correct PIN number, parental settings menu will be displayed:



Parental Settings Menu Operation

- Select an item by using “▼” or “▲” button.
- Use “◀” or “▶” button to set an item.
- Press **OK** button to view more options.

Menu Lock: Menu lock setting enables or disables the menu access. You can disable access to the installation menu or the whole menu system.

Set PIN: Defines a new PIN number. Use numeric buttons to enter a new pin number. You will need to code your new pin a second time for verification purposes.

IMPORTANT: The factory default pin number is **0000**, if you change the pin number make sure you write it down and keep it safe.

Timers

To view Timers menu, press **MENU** button and select Channel List icon by using “◀” or “▶” button. Press **OK** button to view Channel List menu. Use “▼” or “▲” button to highlight Timers and press **OK** to continue:

Setting Sleep Timer

This setting is used for setting the TV to turn off after a certain time.

- Highlight Sleep Timer by using “▼” or “▲” button.

- Use “◀” or “▶” button to set. The timer can be programmed between **Off** and **2.00** hours (120 minutes) in steps of 30 minutes.

Setting Programme Timers

You can set programme timers for a particular programme using this feature.

Press “▼” button to set timers on an event. Programme timer function buttons will be displayed on the screen.

Adding a Timer

- Press **YELLOW** button on the remote control to add a timer. The following menu appears on the screen:

Channel: Changes network type by using “◀” or “▶”.

Timer Type: This feature is unavailable to be set.

Date: Enter a date using the numeric buttons.

Start: Enter a starting time using the numeric buttons.

End: Enter an ending time using the numeric buttons.

Duration: Displays duration between the starting and ending time.

Repeat: Sets a timer to be repeated as Once, Daily or Weekly. Use “◀” or “▶” buttons to select an option.

- Press **GREEN** button to save the timer. Press **RED** button to cancel.

Change/Delete: Controls parental settings on timers.

Editing a Timer

- Select the timer you want to edit by pressing “▼” or “▲” button.
- Press **GREEN** button. Edit Timer menu screen will be displayed.
- When finished with editing, press **GREEN** button to save. You can press **MENU** button to cancel.

Deleting a Timer

- Select the timer you want to delete by pressing “▼” or “▲” button.
- Press **RED** button.
- Select **YES** by using “◀” or “▶” buttons to delete the timer. Select **NO** to cancel.

Configuring Date/Time Settings

Select **Date/Time** in the Settings menu to configure Date/Time settings. Press **OK** button.

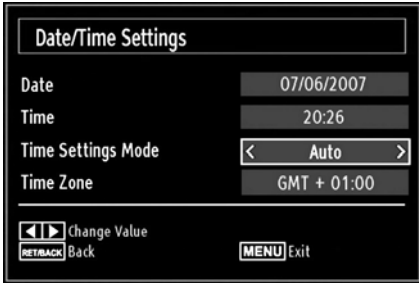

- Use “▼” or “▲” buttons to highlight **Date/Time**.

Date, Time, Time Settings Mode and Time Zone Setting will be available.

Use “▲” or “▼” buttons to highlight the Time Settings Mode. Time Settings Mode is set using “◀” or “▶” buttons. It can be set to AUTO or MANUAL.

When AUTO is selected, Date/Time and Time Zone options will not be available to be set. If MANUAL option is selected as the Time Zone can be altered:

- By pressing “▲” or “▼” buttons select Time Zone.

Use “◀” or “▶” buttons to change the Time Zone between GMT-12 or GMT+12. Date/Time on the top of the menu list will then change according to the selected Time Zone.

- Changes are automatically stored. Press **MENU** to exit.

Configuring Source Settings

You can enable or disable selected source options. The TV will not switch to the disabled source options when **SOURCE** button is pressed.



- Select **Sources** in the Settings menu and press **OK** button.
- Press “▼” or “▲” buttons to select a source.
- Use “◀” or “▶” button to enable or disable the selected source. Changes are automatically stored.

Configuring Other Settings

To view general configuration preferences, select **Other Settings** in the Settings menu and press **OK** button.

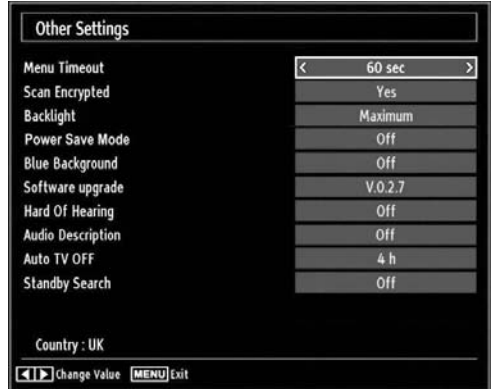

Operation

- Press “▼” or “▲” buttons to select an item.
- Use “◀” or “▶” button to set an option.
- Press **OK** button to view a sub-menu.

Menu Timeout: Changes timeout duration for menu screens.

Scan Encrypted: When this setting is on, search process will locate the encrypted channels as well. If it is set as **Off**, encrypted channels will not be located in automatic search or manual search.

Backlight (optional): This setting controls the backlight level and it can be set to Auto, Maximum, Minimum, Medium and Eco Mode (optional).

Power Save Mode: Use “▼” or “▲” button to select Power Save Mode. Press “◀” or “▶” button to set Power Save Mode as On or Off. See the section, “Environmental Information” in this manual for further information on Power Save Mode.

Note : Backlight function will be invisible if Power Save Mode is set to on.

Blue Background: Activates or deactivates blue background system when the signal is weak or absent.

Software Upgrade: To ensure that your TV always has the most update information, you can use this setting. In order for the proper operation, please ensure that the TV is set to standby mode.

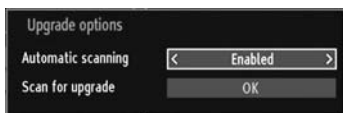

You can enable or disable automatic upgrade by setting **Automatic Scanning** option.

You can manually search for new software by selecting **Scan for upgrade**.

Hard of Hearing: If the broadcaster enables any special signal concerning the audio, you can set this setting as On to receive such signals.

Audio Description: Audio description refers to an additional narration track for blind and visually impaired viewers of visual media, including television and movies. The description narrator talks through the presentation, describing what is happening on the screen during the natural pauses in the audio (and sometimes during dialogue, if deemed necessary). You can use this feature, only if the broadcaster supports that additional narration track.

Auto TV Off: You can set the timeout value of auto off feature. After the timeout value is reached and the TV is not operated for selected time, the TV will go off.

Standby Search (optional): Use “▼” or “▲” button to select Standby Search and then press “◀” or “▶” button to set this setting as On or Off. If you change Standby Search to Off, this function will be unavailable. To use Standby search please make sure that you select Standby Search as On.

If the Standby Search is set to On, when the TV is in standby mode, available broadcasts will be searched. If the TV locates any new or missing broadcasts, a menu screen will be displayed, asking you whether or not to execute these changes.

Other Features

Displaying TV Information: Programme Number, Programme Name, Sound Indicator, time, teletext, channel type and resolution information is displayed on the screen when a new programme is entered or “INFO/I” button is pressed.

Mute Function: Press “⊗” button to disable sound. Mute indicator will be displayed in the upper side of the screen. To cancel mute, there are two alternatives; the first one is pressing the “⊗” button and the second one is increasing the volume level.

Picture Mode Selection: By pressing **PRESETS** button, you can change **Picture Mode** settings in accordance with your viewing requirements. Available options are Dynamic, Natural and Cinema.

Displaying Subtitles: You can enable subtitles by pressing the **SUBTITLE** button of the remote control. Press **SUBTITLE** button again to disable subtitle function.

Analogue Teletext

Teletext system transmits information such as news, sports and weather on your TV. Note that in the signal degrades, for example in poor/adverse weather conditions, some text errors may occur or the teletext mode may be aborted.

Teletext function buttons are listed below:

“☰” **Teletext / Mix** : Activates teletext mode when pressed once. Press again to place the teletext screen over the programme (mix). Pressing again will quit the teletext mode.

“RETURN” **Index**: Selects the teletext index page.

“INFO/?” **Reveal**: Shows hidden information (e.g. solutions of games).

“OK” **Hold**: Holds a text page when convenient. Press again to resume.

“◀/▶” **Subcode Pages** : Selects subcode pages if available when the teletext is activated.

P+ / P- and numbers (0-9): Press to select a page.

Note: Most TV stations use code 100 for their index pages.

Coloured Buttons (RED/GREEN/YELLOW/BLUE)

Your TV supports both **FASTEXT** and **TOP text** systems. When these systems are available, the pages are divided into groups or topics. When **FASTEXT** system is available, sections in a teletext page will become colour-coded and can be selected by pressing the coloured buttons. Press a coloured button that corresponds to with your needs. The coloured writings will appear, showing you which coloured buttons to use when **TOP text** transmission is present. Pressing “▼” or “▲” commands will request the next or previous page respectively.

Tips

Screen Care: Clean the screen with a slightly damp, soft cloth. Do not use abrasive solvents as they may damage the coating layer of the TV screen. For your safety, unplug the mains plug when cleaning the set. When moving the TV, hold it properly from the bottom part.

Image Persistence: Please note that ghosting may occur while displaying a persistent image. LCD TVs' image persistence may disappear after a short time. Try turning off the TV for a while.

To avoid this, do not leave the screen in still picture for extended periods.

No Power: If your TV system has no power, please check the main power cable and connection to the mains socket outlet.

Poor Picture: Have you selected the correct TV system? Is your TV set or house aerial located too close to a non-earthed audio equipment or neon lights, etc.? Mountains or high buildings can cause double pictures or ghost images. Sometimes you can improve the picture quality by changing the direction of the aerial. Is the picture or teletext unrecognisable? Check if you have entered the correct frequency. Please retune the channels. The picture quality may degrade when two peripherals are connected to the TV at the same time. In such a case, disconnect one of the peripherals.

No Picture: Is the aerial connected properly? Are the plugs connected tightly to the aerial socket? Is the aerial cable damaged? Are suitable plugs used to connect the aerial? If you are in doubt, consult your dealer. No Picture means that your TV is not receiving a transmission. Have you selected the correct button on the remote control? Try once more. Also make sure the correct input source has been selected.

Sound: You can not hear any sound. Did you perhaps interrupt the sound, pressing the  button? Sound is coming from only one of the speakers. Is the balance set to one extreme? See **Sound Menu**.

Remote Control: Your TV no longer responds to the remote control. Perhaps the batteries are exhausted. If so you can still use the local buttons on the TV.

Input Sources: If you cannot select an input source, it is possible that no device is connected. Check the AV cables and connections if you have tried to connect a device

Appendix A: PC Input Typical Display Modes

The display has a maximum resolution of 1360x768. The following table is an illustration of some of the typical video display modes. Your TV may not support different resolutions. Supported resolution modes are listed below. If you switch your PC to an unsupported mode, a warning OSD will appear on the screen.

Index	Resolution	Frequency
1	640x400	70 Hz
2	640x480	60 Hz
3	640x480	75 Hz
4	800x600	60 Hz
5	800x600	75 Hz
6	1024x768	60 Hz
7	1024x768	70 Hz
8	1024x768	75 Hz
9	1152x864	75 Hz
10	1280x768	60 Hz
11	1280x1024	60 Hz
12	1360x768	60 Hz

Appendix B: AV and HDMI Signal Compatibility (Input Signal Types)

Source	Supported Signals		Available
EXT (SCART)	PAL 50/60		O
	NTSC 60		O
	RGB 50		O
	RGB 60		O
Side AV	PAL 50/60		O
	NTSC 60		O
YPbPr	480I	60Hz	O
	480P	60Hz	O
	576I	50Hz	O
	576P	50Hz	O
	720P	50Hz	O
	720P	60Hz	O
	1080I	50Hz	O
	1080I	60Hz	O
HDMI1	480I	60Hz	O
	480P	60Hz	O
	576I	50Hz	O
	576P	50Hz	O
	720P	50Hz	O
	720P	60Hz	O
	1080I	50Hz	O
	1080I	60Hz	O
	1080P	50Hz	O
	1080P	60Hz	O
1080P	24 HZ	O	

(X: Not Available, O: Available)

In some cases a signal on the LCD TV may not be displayed properly. The problem may be an inconsistency with standards from the source equipment (DVD, Set-top box, etc.). If you do experience such a problem please contact your dealer and also the manufacturer of the source equipment.

Appendix C: Supported DVI Resolutions

When connecting devices to your TV's connectors by using DVI converter cables (not supplied), you can refer to the following resolution information.

	24Hz	25Hz	30Hz	50Hz	60Hz
480i					<input checked="" type="checkbox"/>
480p					<input checked="" type="checkbox"/>
576i				<input checked="" type="checkbox"/>	
576p				<input checked="" type="checkbox"/>	
720p				<input checked="" type="checkbox"/>	<input checked="" type="checkbox"/>
1080i				<input checked="" type="checkbox"/>	<input checked="" type="checkbox"/>
1080p	<input checked="" type="checkbox"/>	<input checked="" type="checkbox"/>	<input checked="" type="checkbox"/>	<input checked="" type="checkbox"/>	<input checked="" type="checkbox"/>

Appendix D: Supported File Formats for USB Mode

Supported Video Formats

file extension	containers	Video Decoder	Audio codec	Resolution
.mpg .mpeg .dat	mpg, mpeg, ps	MPEG 1	MPEG LPCM	1920x1080
		MPEG2		1920x1080
.avi	AVI	XviD	MP3 LPCM	1920x1080
.ts .tp .trp	TS	MPEG2	MP3	1920x1080
.vob	mpeg, mpg	MPEG2	MP3	1920x1080

Supported File Formats

Media	file extention	codec	Remarks
Music	.mp3	Mpeg 1/2	
Photo	.jpg	baseline	Up to 15360x8640
		progressive	Up to 1024x768

NB. Not all variations of the above formats can be guaranteed to play on this product due to version changes and copyright protection.

Appendix E: Pin Specifications

SCART connector pin specifications

Pin	Input signal	Pin	Input signal
1	AUDIO OUT (RIGHT)	12	Not used
2	AUDIO IN (RIGHT)	13	RGB-R GND
3	AUDIO OUT (LEFT/MONO)	14	GND
4	AUDIO GND	15	RGB-R / S.VHS CHROMINANCE IN
5	RGB-B GND	16	BLANKING SIGNAL
6	AUDIO IN (LEFT/MONO)	17	COMPOSITE VIDEO GND
7	RGB-B IN	18	BLANKING SIGNAL GND
8	AUDIO / RGB SWITCH / 16:9	19	COMPOSITE VIDEO OUT
9	RGB-G GND	20	COMPOSITE VIDEO / S.VHS LUMINANCE IN
10	Not used	21	GND / SHIELD (CHASSIS)
11	RGB-G IN		

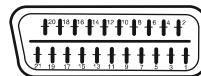

HDMI connector pin specifications

Pin	Input signal	Pin	Input signal
1	TMDS Data2+	11	TMDS Clock Shield
2	TMDS Data2 Shield	12	TMDS Clock-
3	TMDS Data 2-	13	CEC
4	TMDS Data 1+	14	Reserved (N.C. on device)
5	TMDS Data1 Shield	15	SCL
6	TMDS Data1-	16	SDA
7	TMDS Data0+	17	DDC/CED Ground
8	TMDS Data0 Shield	18	+5V Power
9	TMDS Data0-	19	Hot Plug Detect
10	TMDS Clock+		

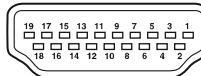

Signal Input

PC RGB Terminal (D-sub 15-pin connector)

Pin	Input signal
1	R
2	G or sync on green
3	B
4	No connection
5	No connection
6	R.GND
7	G.GND
8	B.GND
9	No connection
10	GND
11	No connection
12	[SDA]
13	H.sync or H/V composite sync
14	V.sync. [V.CLK]
15	[SCL]

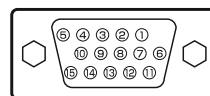

Appendix F: Software Upgrade

- Your TV is capable of finding and updating new software upgrades over broadcast channels.
- For broadcast channels search, TV looks the available channels stored in your settings. So before software upgrade search, it is advised to auto search and update all available channels.

1) Software upgrade search via user interface

- It is possible manually to check if there is a new software upgrade for your TV set.
- Simply navigate on your main menu. Choose **Settings** and select **Other Settings** menu. In **Other Settings** menu navigate on to the **Software Upgrade** item and press **OK** button to open **Upgrade Options** menu.
- In **Upgrade Options** menu select **Scan for upgrade** and press **OK** button.
- If a new upgrade is found, it starts to download the upgrade. A progress bar indicates the remaining download progress. When download completes with success a message is displayed for reboot to activate new software. Press **OK** to continue with the reboot operation.

2) 3.AM search and upgrade mode

- If **Automatic scanning** in **Upgrade Options** menu is enabled, TV wakes up at 03:00 and searches broadcast channels for new software upgrade. If new software is found and downloaded successfully, with next power up TV opens with new software version.

Note on reboot operation: *Reboot is the last step in software upgrade operation if download of new software is finished successfully. During reboot TV makes final initializations. In reboot sequence panel power is closed and front led indicates the activity with blinking. Around 5 minutes later TV restarts with new software activated.*

- If your TV fails to restart in 10 minutes, unplug power for 10 minutes and re-plug again. TV should open with new software safely. If you still can not get TV working, please kindly repeat unplug and plug sequence a few times more. If your set still can not operate, please call the service personnel to fix the problem for you.

Caution: *While led is blinking during reboot do not unplug your TV's power. Doing this may cause your TV not to re-open again and can only be fixed by service personnel.*

Specifications

TV BROADCASTING

PAL/SECAM B/G D/K K' I/I' L/L'

RECEIVING CHANNELS

VHF (BAND I/III)

UHF (BAND U)

HYPERBAND

CONTRAST RATIO

1000:1

NUMBER OF PRESET CHANNELS

1000

CHANNEL INDICATOR

On Screen Display

RF AERIAL INPUT

75 Ohm (unbalanced)

OPERATING VOLTAGE

220-240V AC, 50 Hz.

AUDIO

German + Nicam Stereo

AUDIO OUTPUT POWER (W_{RMS}) (10% THD)

2 x 2,5

POWER CONSUMPTION (W)

40 W (max)

< 1 W (Standby)

PANEL

22" Wide Screen

DIMENSIONS (mm)

DxLxH (With foot): 134 x 532 x 375

Weight (Kg): 5,05

DxLxH (Without foot): 53 x 532 x 347

Weight (Kg): 4.80

Wall mounting bracket screw specification:

four M4 screws, size M4 X 18 mm.

Digital Reception	MHEG-5 ENGINE compliant with ISO/IEC 13522-5 UK engine Profile 1	for UK
	Object carousel support compliant with ISO/IEC 135818-6 and UK DTT profile	
	Frequency range: 474-850 MHz for UK models	
	170-862 MHz for EU models	
	Transmission standard: DVB-T. MPEG-2	
	Demodulation: COFDM with 2K/8K FFT mode	
	FEC: all DVB modes	
	Video: MP@ML, PAL, 4:3/16:9	
	Audio: MPEG Layer I&II 32/44.1/48kHz.	

DVB-T functionality information

This DVB receiver is only suitable for use in the country which it was designed to be used in.

Although this DVB receiver conforms to the latest DVB specifications at the time of manufacture, we cannot guarantee compatibility with future DVB transmissions due to changes that may be implemented in broadcast signals and technologies.

Some digital television functions may not be available in all countries.

We continually strive to improve our products; therefore, specifications may change without prior notice.

For advice on where to purchase accessories, please contact the store where you purchased your equipment.

Product Guarantee

This product is guaranteed against manufacturing defects for a period of

1 Year

This does not cover the product where the fault is due to misuse, abuse, use in contravention of the instructions, or where the product has been the subject of unauthorised modifications or alterations, or has been the subject of commercial use

In the event of a problem with the product within the guarantee period please return it to your nearest Argos store

If the item is shown to have had an inherent defect present at the time of sale, the store will provide you with a replacement

Your statutory rights remain unaffected

**Guarantor; Home Retail Group
489 - 499 Avebury Boulevard
Central Milton Keynes
MK9 2NW**

Contents

Features	34
General Properties.....	34
Safety Information	35
Notes on Discs	35
On handling discs	35
On cleaning.....	35
Licence Notification	35
How to Watch a DVD.....	35
DVD Control Panel Buttons.....	36
Overview of the Remote Control	36
General Operation	37
General Playback	38
Basic Play.....	38
For your reference:	38
Notes on Playback:.....	38
Setup Menu Items	38
Video Setup Page.....	38
TV Type.....	38
Language Setup	38
OSD LANG	38
AUDIO	38
DISC MENU.....	38
SUBTITLE.....	38
Preferences	39
DEFAULT	39
DOWNMIX	39
PASSWORD (Change Password):	39
SPDIF OUTPUT.....	39
Troubleshooting.....	39
The picture quality is poor (DVD).....	39
Disc does not play	39
Wrong OSD language.....	39
Some functions (Angle, Zoom etc) do not work	40
No picture	40
No sound	40
Distorted sound.....	40
No response from remote control	40
If nothing works.....	40
Definition of Terms.....	40
Disc Types Compatible with This Unit	41
Specifications	41

Features

General Properties



- DVD / CD / CD-R / CD-RW / MP3 / JPEG / MPEG playback.
- NTSC/PAL playback (according to disc content)
- LPCM audio via coaxial digital audio output. (optional).
- Multi-Audio (up to 8) support (According to disc content)
- Multi-Subtitle (up to 32) support (According to disc content)
- Multi-Angle (up to 9) support (According to disc content)
- 8 level parental control
- Fast forward and rewind in 5 different speeds. (2x, 4x, 8x, 16x, 32x)
- Slow motion playback in 4 different speeds. (1/2x, 1/4x, 1/8x, 1/16x forward)
- Frame by frame forward playback.
- Search Mode
- Repeat
- Coaxial audio output (optional)
- Copied disks may be incompatible.

Note

- This DVD player may not support some MP3 recordings due to differences in recording formats or disc type.
- Please read the owner's manual about MP3 playback.
- CD-R/CD-RW discs recorded by CD-DA method can be played. Some CD-R/CD-RW discs may be incompatible due to laser pick-up and disc design.
- DVD-R/RW discs recorded by DVD-Video method can be played. Some DVD-R/RW discs may be incompatible due to laser pick-up and disc design.
- Some discs may be incompatible with JPEG Viewer function due to different recording format or condition of the discs.

Playback Region Number

Both the DVD player and the discs are coded by region. These regional codes must match in order for the disc to play. If the codes do not match, the disc will not play.

- Some discs include region codes as shown on the right. 
- The number inside the symbol refers to a region of the world, and a disc encoded in a specific region format can only be played back on DVD player with the same region code.
- The Region Number is described as 2 for this TV set. 

Safety Information

CAUTION

DVD Player is a class 1 laser product. However this product uses a visible laser beam which could cause hazardous radiation exposure. Be sure to operate the player correctly as instructed.

**CLASS 1
LASER PRODUCT**

RISK OF ELECTRIC SHOCK

The lightning flash with arrowhead symbol, within an equilateral triangle, is intended to alert the user to the presence of uninsulated "dangerous voltage" within the product's enclosure that may be of sufficient magnitude to constitute a risk of electric shock of persons.



The exclamation point within an equilateral triangle is intended to alert the user to the presence of important operating and maintenance (servicing) instructions in the literature accompanying the appliance.



Notes on Discs

On handling discs

- To keep the disc clean, handle the disc by its edge. Do not touch the surface.
- Do not stick paper or tape on the disc.
- If the disc is contaminated with any substance like glue remove before using it.

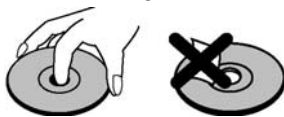

- Do not expose the disc to direct sunlight or heat sources such as hot air ducts, or leave it in a car parked in direct sunlight as the temperature can rise quickly and damage the disc.
- After playing, store the disc in its case.

On cleaning

- Before playing, clean the disc with a cleaning cloth. Wipe the disc from the center out.

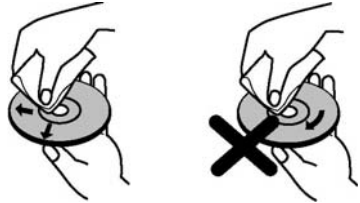

- Do not use solvents such as benzene, thinner, commercially available cleaners or anti-static spray intended for vinyl LPs.

Licence Notification

- This product incorporates copyright protection technology that is protected by U.S. patents and other intellectual property rights. Use of this copyright protection technology must be authorized by Rovi Corporation, and is intended for home and other limited viewing uses only unless otherwise authorized by Rovi Corporation. Reverse engineering and disassembly are prohibited.

How to Watch a DVD

When placing a disc into the loader, labeled side of the disc should be on the front:

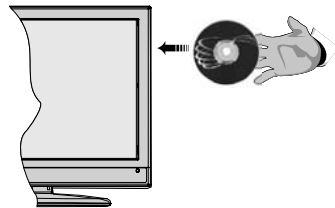

When TV set is turned on, first switch to DVD source by using the **SOURCE** button on the remote control. Press play on the remote control, or directly press play button at the front panel. If there is no disc inside the loader, place a DVD first and press play.

DVD Control Panel Buttons

A. Disc loader

B. Play / Pause

Plays/pauses the disc. When DVD menu (root menu) is active, this button functions as "button select" (selects the highlighted item in menu) if this is not prohibited by the disc.

C. Stop / Eject

Stop playing disc / Eject or Load the disc Note:

- You cannot eject the disc via the remote control.
- While playing a file, you should press STOP button three times to eject.

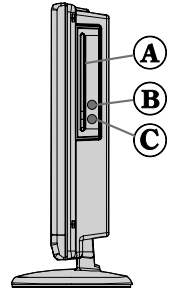

Overview of the Remote Control

1. Standby
2. Numeric buttons
3. Return back
4. Language selection (Set language)
5. Display time / DVD menu
6. Clear
7. Stop
8. No function
9. Rapid Reverse
10. Rapid advance
11. Info
12. Zoom
13. Repeat
14. Root
15. Menu
16. Title
17. OK / Select
18. Navigation Buttons
19. Subtitle
20. Angle
21. Search mode
22. Play
23. Pause
24. Skip next
25. Skip previous

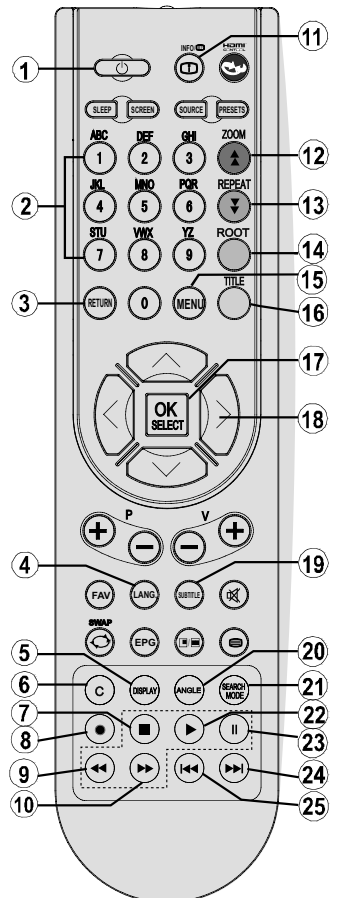

General Operation

You can operate DVD, movie CD, music or picture CD's content by using the proper buttons on your remote control. Below are main functions of commonly used remote control buttons.

Buttons on the Remote Control	DVD Playback	Movie Playback	Picture Playback	Music Playback
▶	Play	Play	Play	Play
⏸	Pause	Pause	Pause	Pause
■	Stop	Stop	Stop	Stop
⏮ / ⏭	Skip backward/forward	Skip backward/forward	Previous / Next	Previous / Next
◀ / ▶	Shifts the zoomed picture left or right (if available).			
▼ / ▲	Highlights a menu item. / Shifts the zoomed picture up or down (if available).			
⏪ / ⏩	Rapid advance / Rapid reverse			
ANGLE	Views the scene from different angles (if available).	Changes slide effect (depends on the content).		X
C	Clears digit (if available).			
DISPLAY	Displays time / Views main setup menu			
INFO	Time counter mode selection (during playback). Press repeatedly to switch between modes.			
LANG.	Audio language.		X	X
MENU	Displays TV menu.			
OK / SELECT	Enter / View / Play			
REPEAT	Displays repeat options.			
RETURN	Returns back to the previous menu (if available).			
ROOT	Goes back to the root folder (if available).			
SEARCH MODE (*)	Direct selection of scenes or time.		Selects the desired file.	Selects the desired file.
SUBTITLE	Subtitle on-off. Press repeatedly to switch between subtitle options.		X	X
SWAP	Media source selection.			
TITLE	Displays disc menu (if available).	Displays disc menu (if available).	X	X
ZOOM	Zooms picture. Press repeatedly to switch between zoom options.			

Other Functions – Button Combinations (During playback)	
⏸ + ⏭	Slow forward.
[⏸ + ⏭] + ⏮ ⏭	Sets slow forward speed.
⏭ + ⏭	Sets rapid advance speed.
⏮ + ⏮	Sets rapid reverse speed.
■ + ■	Confirms stop command.
⏸ + ⏭	Press ⏭ repeatedly to advance manually.

(*) You can switch to title by pressing numeric keys directly. You need to press 0 and then digit key to switch one digit titles (example: to select 5, press 0 and 5).

General Playback

Basic Play

1. Press on the power button
2. Please insert a disc to the loader.

The disc will be automatically loaded and play commences if the disc does not have any menus recorded on it.

A menu may appear on the TV screen after a few moments or the film may start immediately after the introduction of the Film Company. This behaviour depends on the disc content and may change.

Note: Step 3 and 4 is available only when a menu is recorded on the disc.

3. Press “▼” / “▲” / ◀ / ▶ or the number button (s) to select the preferred title.
4. Press SELECT.

Play of the selected items now starts. The played item may be a motion picture, a still picture or another submenu depending on the disc.

For your reference:

If an action corresponding to a button is prohibited the “” symbol appears.

Notes on Playback:

1. No sound will be heard during Rapid advance or Rapid reverse.
2. No sound will be heard during Slow motion play.
3. Reverse slow motion play is not available.
4. In some cases, the subtitle language is not changed immediately to the selected one.
5. When the preferred language is not selected even after pressing the button several times, it means that the language is not available on the disc.
6. When the player is restarted or the disc is changed, the subtitle selection is automatically changed back to the initial settings.
7. If a language is selected, not supported by the disc, the subtitle language will automatically be set to the disc's priority language.
8. Usually a circulation will happen while switching to another language, that is you can cancel the subtitle by pressing this button a number of times until “Subtitle Off” appears on the screen.
9. When the power is turned on or the disc is removed, the language heard is the one selected at the initial settings. If this language is not recorded on the disc, only the available language on the disc will be heard.
10. Some DVDs may not contain root and/or title menus.

11. Reverse stepping is not available.

12. For your convenience:

If you attempt to enter a number greater than the total time of the current title, the time search box disappears and “ Input Invalid” message appears on up-left corner of screen.

13. Slide Show is disabled when the ZOOM mode is on.

Setup Menu Items

Press the **DISPLAY** button to bring up the DVD video set up page.

Video Setup Page



TV Type

TV Type is only available as 'PAL'. The TV set also supports NTSC signal; however, the signal will be converted to PAL when it appears on the screen.

Language Setup



OSD LANG

You can select the default OSD language of the player menus

AUDIO

You can select the default audio language if supported by the DVD disc.

DISC MENU

You can select the DVD's disc menu language among these languages. Disc menu appears in the selected language, if supported by the DVD disc.

SUBTITLE

You can select the default subtitle language if supported by the DVD disc.

Preferences



DEFAULT

If you choose RESET and press SELECT, the factory-presets are loaded. Parental level and parental password does not change.

DOWNMIX

This mode can be selected when the digital audio output of the TV is used.

SURROUND: Surround sound output.

STEREO: Two channels stereo.

PARENTAL (Parental Level)



Playing some DVDs can be limited depending on the age of users. The "Parental Control" function allows playback limitation level to be set by the parent.

Parental Level can be adjusted to one of the eight levels. Level "8 ADULT" adjustment let you watch all of the DVD titles ignoring the DVD disc's parental level. You can watch the DVD discs, which has the same or lower parental level than the player's level only.

PASSWORD (Change Password):

Using this item you can change the current password.

To change the password you will be prompted to enter your old password. After you have entered your old password, you can now enter the new 4-digit password.

You can use C key to delete the incorrect entry.

Note: Factory preset of the password is "0000". You have to enter XXXX digital password every time you want to change the parental level. If you forget your password please contact technical service.

SPDIF OUTPUT



You can set Spdif Output as PCM or RAW. If you select PCM from SPDIF Output in DVD menu and play DVD with Dolby audio, you can get audio output with two channels via the speakers and the SPDIF Out. If you select RAW from SPDIF Output in DVD menu and play DVD with Dolby audio, speakers will be muted and you can get 5+1 Dolby audio via the SPDIF Out.

Troubleshooting

The picture quality is poor (DVD)

- Make sure the DVD disc surface is not damaged. (Scratch, fingerprint etc.)
- Clean the DVD disc and try again.

See instructions described in "Notes on Discs" to clean your disc properly.

- Ensure that the DVD disc is in the drawer with the label uppermost.
- A damp DVD disc or condensation may effect the equipment. Wait for 1 to 2 hours in Stand-by to dry the equipment.

Disc does not play

- No disc in the machine.
Place a disc into the loader.
- Disc incorrectly loaded.

Ensure that the DVD disc is in the drawer with the label uppermost.

- Wrong type of disc. The machine cannot play CD-ROMS etc.
- The region code of the DVD must match the player.

Wrong OSD language

- Select the language in the set-up menu.
- The language for the sound or subtitles on a DVD cannot be changed.
- Multilingual sound and/or subtitles not recorded on the DVD.
- Try to change the sound or subtitles using DVD's title menu. Some DVD's do not allow the user to change these settings without using the disc's menu

Some functions (Angle, Zoom etc) do not work

- These functions are not available on the DVD.
- Angle can only be changed when the angle symbol is displayed.

No picture

- Have you pressed the correct buttons on the remote control? Try once more.

No sound

- Check the volume is set to an audible level.
- Make sure you have not switched the sound off accidentally.

Distorted sound

- Check that the appropriate listening mode setting is correct.

No response from remote control

- Make sure the remote control is in the correct mode.
- Check batteries are fitted correctly.
- Change the batteries.

If nothing works

If you have tried the above solutions and none seem to work, try switching your TV-DVD off and on again. If this does not work, contact your supplier or TV-DVD repair technician. Never attempt to repair a defective TV-DVD yourself.

Definition of Terms

Angle

Recorded onto some DVD discs are scenes, which have been simultaneously shot from a number of different angles (the same scene is shot from the front, from the left side, from the right side, etc.). With such discs, the ANGLE button can be used to view the scene from different angles.

Chapter Number

These numbers are recorded on DVD discs. A title is subdivided into many sections, each of which are numbered, and specific parts of video presentations can be searched quickly using these numbers.

DVD

This refers to a high-density optical disc on which high-quality pictures and sound have been recorded by means of digital signals. Incorporating a new video compression technology (MPEG II) and high-density recording technology. DVD enables aesthetically pleasing full-motion video to be recorded over long periods of time (for instance, a whole movie can be recorded).

DVD has a structure consisting of two 0.6-mm thin discs, which are adhered to each other. Since the thinner the disc, the higher the density at which the information can be recorded, a DVD disc has a greater capacity than a single 1.2 mm thick disc. Since the two thin discs are adhered to each other, there is the potential to achieve double-sided play sometime in the future for even longer duration play.

Subtitles

These are printed lines appearing at the bottom of the screen, which translate or transcribe the dialogue. They are recorded on the DVD discs.

Time Number

This indicates the playtime, which has elapsed from the start of a disc or a title. It can be used to find a specific scene quickly. (Not all discs permit the time search feature to be used. Availability is determined by the disc's manufacturer.)

Title Number

These numbers are recorded on DVD discs. When a disc contains two or more movies, these movies are numbered as title 1, title 2, etc.

Track Number

These numbers are assigned to the tracks, which are recorded on AudioCDs. They enable specific tracks to be located quickly.





LPCM

LPCM stands for Pulse Code Modulation and is digital audio.

MPEG

Short for Moving Picture Experts Group. This is an international standard for compression of moving images. On some DVDs digital audio has been compressed and recorded in this format.

Disc Types Compatible with This Unit

Disc Types (Logos)	Recording Types	Disc Size	Max. Playing Time	Characteristics
DVD 	Audio + Video	12 cm	Single-sided: 240 min. Double-sided: 480 min.	<ul style="list-style-type: none"> DVD contains excellent sound and video due to Dolby Digital and MPEG-2 System. Various screen and audio functions can be easily selected through the on screen menu.
		8 cm	Single-sided: 80 min. Double-sided: 160 min.	
AUDIO-CD 	Audio	12 cm	74 min.	<ul style="list-style-type: none"> An LP is recorded as an analog signal with more distortion. CD is recorded as a Digital Signal with better audio quality, less distortion and less deterioration of audio quality over time.
		8 cm	20 min.	
MP3-CD 	Audio (xxxx.mp3)	12 cm	It depends on MP3 quality.	<ul style="list-style-type: none"> MP3 is recorded as a Digital Signal with better audio quality, less distortion and less deterioration of audio quality over time.
		8 cm		
PICTURE-CD 	Video (still picture)	12 cm	It depends on JPEG quality.	<ul style="list-style-type: none"> JPEG is recorded as a Digital Signal with better picture quality over time.
		8 cm		

Specifications

Types of Discs Supported	DVD: SS/SL 4.7" (DVD-5) SS/DL 4.7" (DVD-9) DS/SL 4.7" (DVD-10) DS/DL 4.7" (DVD-18)	CD-DA CD-R CD-RW MP-3/JPEG
Video Type	MPEG-2 Video Standard Decoding (MPEG-1 supported) Full-Screen Video Display of 720 x 576 (PAL) & 720 x 480 (NTSC) pixels 50 and 60 Hz frame refresh rates (PAL & NTSC) Digital bit-stream processing rate up to 108Mbits/sec Line resolution more than 500 lines	
Audio Type	MPEG Multichannel Decoding LPCM	
Audio Output	Analog Outputs: 24 bit /48, 44.1kHz down-sampling DAC	

IMPORTANT - If placing TV into cabinet or alcove, ensure there is at least a 100mm (10cm) gap to the sides, rear and top of the TV. This is to allow for adequate ventilation during operation. Please read the main Users Guide for more safety information before installation.

Detachable Stand Installation Method

1. Stand is placed on a flat surface.

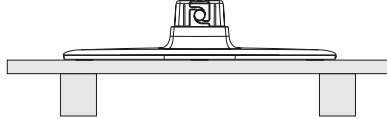

2. The product is held over the stand so that it coincides with the stand mounting point and then it is left to be mounted with its own weight.

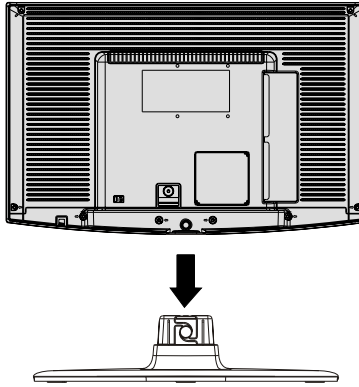

Detachable Stand Uninstallation Method

1. TV is laid on a soft flat surface to avoid scratches, so that backcover will be on topside.
2. Push the button on the stem of the stand.

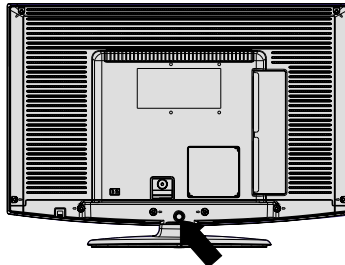

3. Stand is pulled back.
4. Stand is detached.

1

insert the batteries into your handset

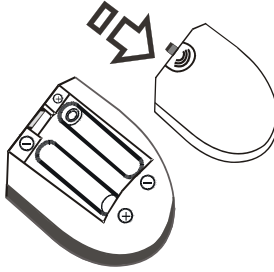

2a

either connect the aerial straight to your TV...

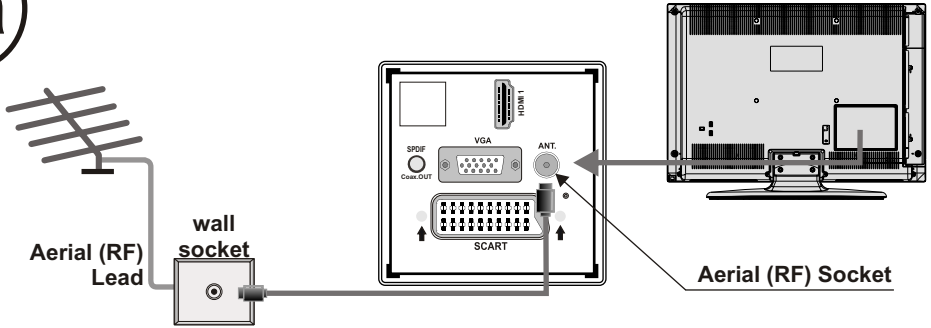

2b

...or connect the aerial through a VCR...

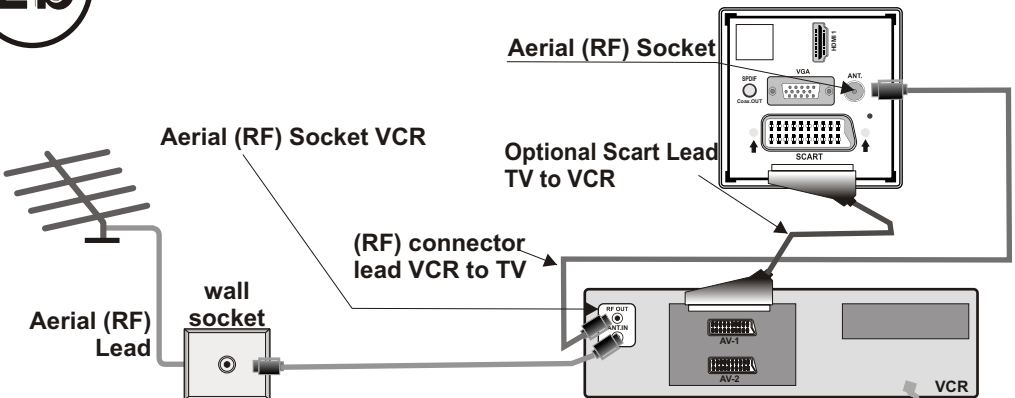

• It is recommended that a scart lead should be fitted between your TV and VCR to enhance your picture and sound quality. Scart leads are essential if you have a stereo TV and VCR and wish to obtain stereo sound from your equipment. These leads can be purchased from your Hitachi dealer or any good High Street electrical retailer.

2c

...or through a HDMI and YPbPr products (DVD-RW)

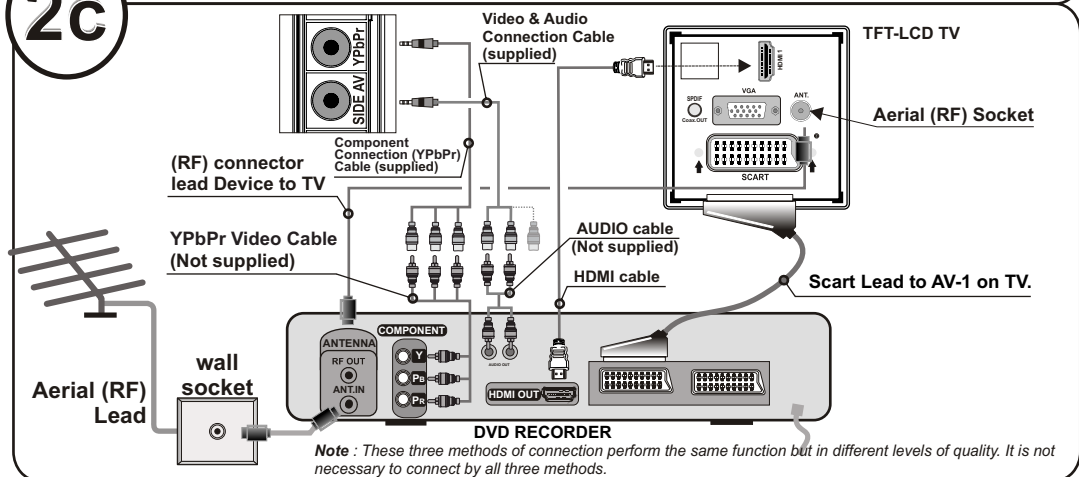

• High Definition

Your LCD Television is capable of displaying High Definition pictures from devices such as a High Definition Satellite Receiver or DVD Device. These devices must be connected via the HDMI socket or Component Socket.

2d

...or through a VCR and satellite decoder.

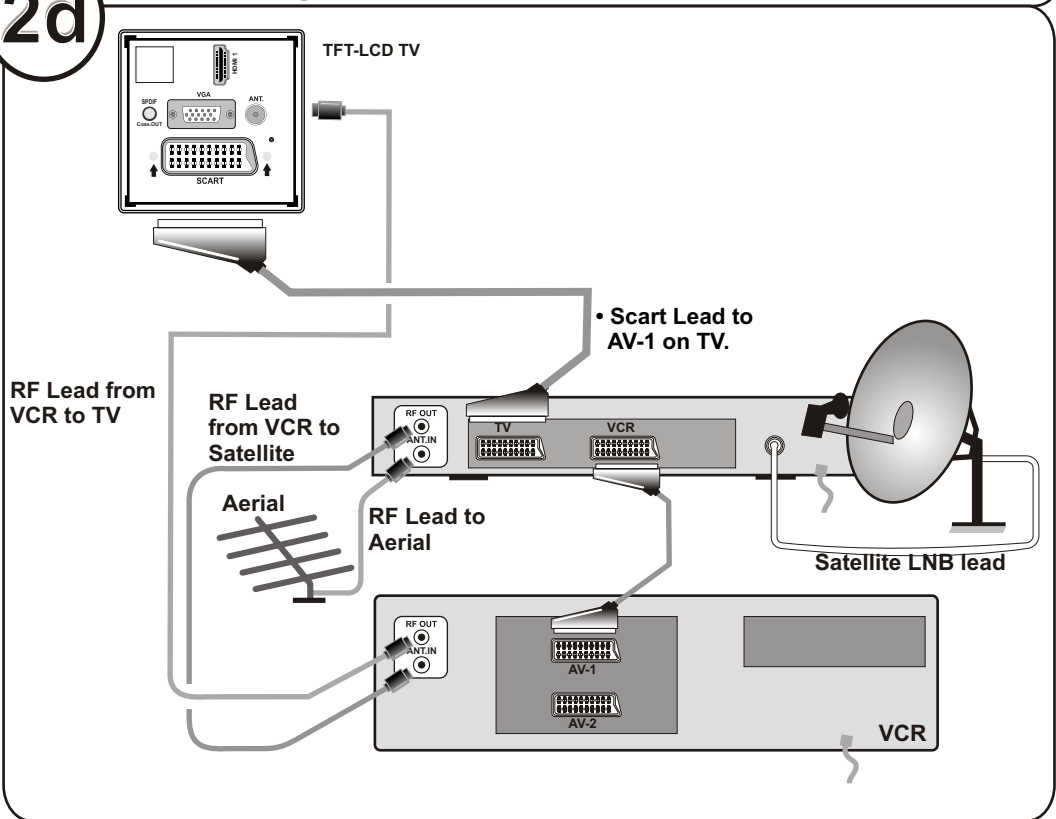

3

connect the TV plug to the mains socket

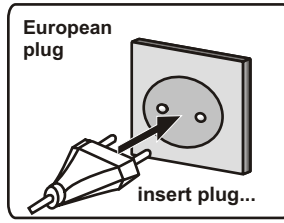
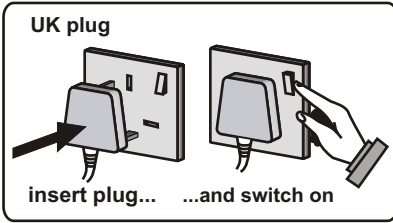

4

Press the "⏻" button, - or + button on the TV. The TV will then switch on.

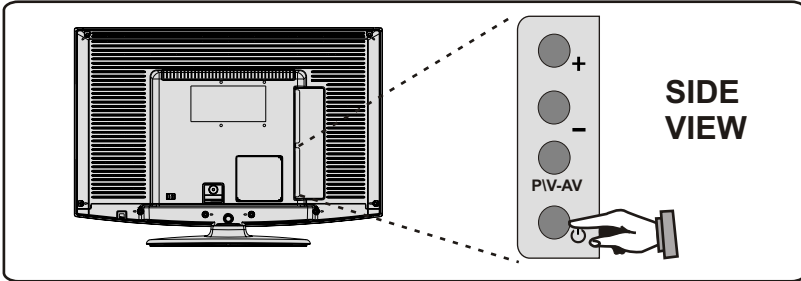

NB: When the set is first switched on, the set will be in standby and the indicator on the front of the set will illuminate red (at first, the red and blue leds will flash alternately). Press Operate/Standby or channel up down (P- , P+) or numeric buttons (1, 2, 3, ...) to operate.

basic functions of remote control

To select a programme number.

Programme Up
Programme Down

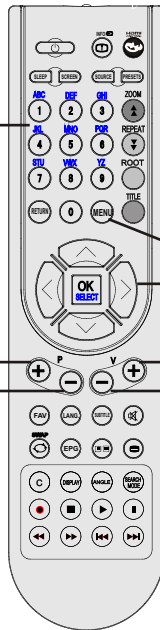

To enter the main menu
For navigation of the menus

Volume Up
Volume Down

5

start A.P.S. (Auto Programming System)

1

When the TV is operated for the first time, installation wizard will guide you through the process. First, language selection screen will be displayed:

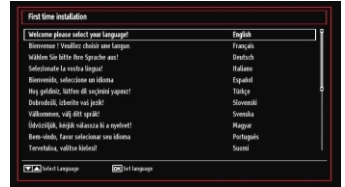

2

- Use "up" or "down" buttons to select your language and press OK button to set selected language and continue.
- After selecting the language, "Welcome!" screen will be displayed, requiring you to set Country, Teletext Language and Scan Encrypted options.



3

- By pressing "left" or "right" button, select the country you want to set and press "down" button to highlight Teletext Language option. Use "left" or "right" button to select desired Teletext Language.
- Press "down" button after setting Teletext Language option. Scan Encrypted will be then highlighted. You can set Scan Encrypted as Yes if you want to scan coded stations. Afterwards select the desired Teletext Language.
- Press OK button on the remote control to continue and the following message will be displayed on the screen:

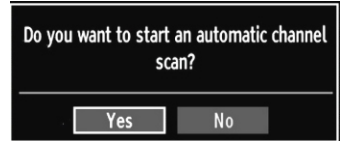

4

- To select the "Yes" or "No" option, highlight the item by using "left" or "right" buttons and press button.
- Afterwards, the following OSD will be displayed on the screen and the television will search for digital terrestrial and analogue TV broadcasts.



5

- **Note:** You can press MENU button to cancel.
- After all the available stations are stored, Channel List will be displayed on the screen. If you like the sort channels, according to the LCN, please select "Yes" and then press "OK".
- Press OK button to quit channel list and watch TV.

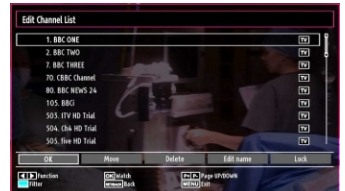

important note.

Once the TV has found all your local stations, they are then automatically assigned a programme number and name, if available from the broadcast.



important note before using DVD

In TV mode repeatedly press the AV button until DVD is selected then press the DVD button on the remote control.

DVD cannot be operated unless user selects DVD mode on remote control.

6

how to watch a DVD

1

Switch the TV on.

2

Press **DVD** button on Remote Control.

3

Press play button if there is a disc inside of the loader.

4

If there is no disc inside of the loader please insert a disc properly.

5

Select the preferred menu item from DVD menu when it's displayed and press SELECT.

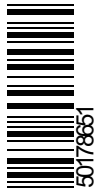

HITACHI

Inspire the Next

