

HITACHI

Inspire the Next

19" LCD Colour Television

Instructions for use

GB

L19HP03U

HDMITM
HIGH-DEFINITION MULTIMEDIA INTERFACE

digital 
Approved product

HD
ready



HITACHI

Contents

Features	3	Automatic Search	25
Accessories	3	Manual Search	25
Introduction	4	Configuration	26
Preparation	4	Audio Language	26
Safety Precautions	4	Subtitle	26
Power Source	5	Favourite Mode	26
Information for Users in European Union		EPG Preference	26
Countries	6	Receiver Upgrade	27
LCD Screen	6	Automatic Download (Automatic	
Overview of the Remote Control	7	Upgrade)	27
LCD TV and Operating Buttons	8	Search for New Version (Manual	
Viewing the Connections	9	Upgrade)	27
Power Connection	11	Parental Settings	27
Aerial Connection	11	Timers	28
Connecting the LCD TV to a PC	12	Language	29
Connecting an external DVD Player	13	TV Setup	29
Using Other Connectors	14	Common Interface	29
Connecting Other Equipment via Scart	15	Navigating the Analogue TV Menu System	30
Inserting Batteries in the Remote Control		Analogue TV Menu Map	31
Handset	16	Analogue TV Menu System	32
Handling the Remote Control	16	Sound Menu	32
Operating Range for the Remote Control	16	Volume	32
Switching the TV On/Off	17	Balance	32
To Switch the TV On	17	Sound Mode	32
To Switch the TV Off	17	AVL	32
Input Selection	17	Effect	32
Basic Operations	18	Equalizer	32
Operation with the Buttons on the TV	18	HP Volume	32
Volume Setting	18	Store	32
Programme Selection	18	Picture Menu	32
Entering Main Menu	18	Picture Mode	32
AV Mode	18	Brightness/Contrast/Colour/	33
Operation with the Remote Control	18	Sharpness/Tint	33
Volume Setting	18	Colour Temp	33
Programme Selection (Previous or Next		Room Lighting	33
Programme)	18	Picture Zoom	33
Programme Selection (Direct Access)	18	Store	33
Initial Settings	19	Features Menu	33
General Operation	19	Sleep Timer	33
Information Banner on DTV	19	Language	33
Electronic Programme Guide (EPG)	20	Child Lock	33
Displaying the Subtitles	21	Menu Colour	33
Digital Teletext	21	Favourite Mode	33
Over Air Download	22	Install Menu	34
Widescreen	22	Programming	34
IDTV Menu System	22	Programme	34
Channel List	22	Band	34
Navigating the Entire Channel List	23	Channel	34
Deleting the Channels in the Channel List	23	Standard	34
Renaming Channels	23	Colour System	34
Adding Locks to Channels	23	Search	34
Setting Favourites	24	VCR Mode	34
On Screen Help	24	Decoder	34
Installation	24	Store	34
Add New Channels	25	A.P.S.	35

A.P.S. Country	35
Teletext Region	35
Install menu in AV modes	35
Programming	35
Colour System	35
Program Table	35
Name	36
Move	36
Delete	36
APS (Auto Programming System)	36
Favourite Mode	36
Program Lock	36
Enter PIN	36
Change PIN	36
PC Mode Menu System	37
Sound Menu	37
Feature Menu	37
PC Picture Menu	37
Geometry Menu	37
H. (Horizontal) Position	37
V. (Vertical) Position	37
Clock	37
Phase	37
Auto Adjustment	38
Displaying TV Information	38
Mute Function	38
Personal Preference	38
Zoom Modes	38
Auto	38
4:3	38
16:9	38
Cinema	38
Subtitle	38
Teletext	39
Tips	40
Screen Care	40
No Power	40
Poor Picture	40
Input Sources	40
CI Module	40
Appendix A: PC Input Typical Display Modes	41
Specifications	42
Pin Specifications	43
UK Guarantee	44

Features

- Remote controlled colour television.
- Fully integrated digital TV (DVB-T).
- 100 programmes from VHF, UHF bands or cable channels can be preset.
- It can tune cable channels.
- Controlling the TV is very easy by its menu driven system.
- It has a scart socket for external devices (e.g. video games, audio set, etc.).
- Stereo sound system (German + Nicam).
- Full function teletext .
- Fastext (10 pages), top text.
- Favourite channel.
- Channel lock.
- Headphone connection.
- A.P.S. (Automatic Programming System).
- All programmes can be named.
- Forward or backward automatic tuning.
- Sleep timer.
- Child lock.
- Automatic sound mute when no transmission.
- NTSC playback.
- AV in is available.
- It has one HDMI connectors for digital video and audio. This connection is also designed to accept high definition signals.
- AVL (automatic volume limiting).
- When no valid signal is detected, after 5 minutes the TV switches itself automatically to standby mode.
- PLL (frequency search).
- PC input.
- Plug & Play for Windows 9X, ME, 2000, XP, Vista.

Accessories



Remote Controller
RC1055

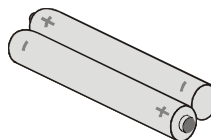

Batteries
2 XAAA



Instruction Book



Quick Guide

Introduction



Thank you for choosing this product. This manual will guide you for the proper operation of your TV. Before operating the TV, please read this manual throughly.

Please do keep this manual in a safe place for future references.

Preparation

For ventilation, leave a free space of at least 10 cm all around the set. To prevent any fault and unsafe situations, please do not place any objects on top of the set.

Use this device in moderate climates.

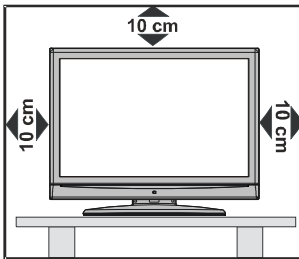

Safety Precautions

Please read the following recommended safety precautions carefully for your safety.

IMPORTANT SAFETY INFORMATION ON OPERATING YOUR TV

Do's and Don'ts

DO's



This Television has been designed and manufactured to meet international safety standards, but like any electrical equipment, care must be taken if you are to obtain the best results and safety is to be assured.

DO read the operating instructions before you attempt to use the equipment.

DO consult your dealer if you are in any doubt about installation, operation or safety of your equipment.

DO be careful with glass panels or doors on equipment.

This TV is supplied with a fitted mains plug. This plug must not be cut off as it may contain a special radio interference filter, the removal of which could lead to impaired performance. If you wish to extend the lead, obtain an appropriate safety approved extension lead or consult your dealer.

Observe the manufacturers instructions when connecting extension leads to the TV. Check the fuse rating on the new plug, this should be fitted with a 5 Amp fuse which conforms to either ASTA or BSI (BS1 362) approvals, these are easily identifiable by either the  or  symbols. If you are in any doubt about the installation of an extension lead, please consult a competent electrician.

DON'Ts

DON'T continue to operate the equipment if you are in any doubt about it working normally, or if it is damaged in any way switch off, withdraw the mains plug and consult your dealer.

DON'T place water filled vessels on top of T.V. cabinets.

DON'T remove any fixed cover as this may expose dangerous voltages.

DON'T leave equipment switched on when it is unattended unless it is specifically stated that it is designed for unattended operation or has a stand-by mode. Switch off using the switch on the equipment and make sure your family know how to do this. Special arrangements may need to be made for infirm or handicapped people.

DON'T use equipment such as personal stereos or radios so that you are distracted from the requirements of traffic safety. It is illegal to watch television whilst driving.

DON'T obstruct the ventilation of the equipment, for example with curtains or soft furnishings. Overheating will cause damage and shorten the life of the equipment.

DON'T use makeshift stands and NEVER fix legs or stands to the TV with any screws other than those provided - to ensure complete safety always use the manufacturers approved stand with the fixings provided.

DON'T allow electrical equipment to be exposed to rain or moisture.

ABOVE ALL

- **NEVER let anyone, especially children push anything into holes, slots or any other opening in the case - this could result in a fatal electric shock.**
- **NEVER guess or take chances with electrical equipment of any kind - it is better to be safe than sorry!**

Power Source

The TV set should be operated only from a 220-240 V AC, 50 Hz outlet. Ensure that you select the correct voltage setting for your convenience.

Power Cord

Do not place the set, a piece of furniture, etc. on the power cord (mains lead) or pinch the cord. Handle the power cord by the plug. Do not pull out the plug by tugging the cord and never touch the power cord when your hands are wet as this could cause a short circuit or electric shock. Never make a knot in the cord or tie it with other cords. The power cords should be placed in such a way that they are not likely to be stepped on. A damaged power cord can cause fire or give you an electric shock. When the power cord is damaged and needs to be replaced, it should be done by qualified personnel.

Moisture and Water

Do not use this device in a humid and damp place (avoid the bathroom, the sink in the kitchen, and near the washing machine). Do not expose this equipment to rain or water, as this may be dangerous and do not place objects filled with liquids, such as flower vases, on top of the set. The set must not be subjected to dripping or splashing.

If any solid object or liquid falls into the cabinet,



unplug the set and have it checked by qualified personnel before operating it any further.

Cleaning

Before cleaning, unplug the adaptor from the wall outlet. Do not use liquid or aerosol cleaners. Use soft and dry cloth.

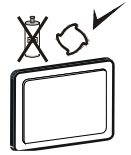

Ventilation

The slots and openings on the back cover are intended for ventilation and to ensure reliable operation. To prevent overheating, these openings must not be blocked or covered in anyway.

Heat and Flames

The set should not be placed near to open flames and sources of intense heat, such as an electric heater. Ensure that no open flame sources, such as lighted candles, are placed on top of the set. Batteries shall not be exposed to excessive heat such as sunshine, fire or the like.



Lightning

In case of storm and lightning or when going on holiday, disconnect the power cord from the wall outlet.



Replacement Parts

When replacement parts are required, make sure that the service technician has used replacement parts, which are specified by the manufacturer or have the same specifications as the original one. Unauthorized substitutions may result in fire, electrical shock or other hazards.

Servicing

Please refer all servicing to qualified personnel. Do not remove the cover yourself as this may result in an electric shock.

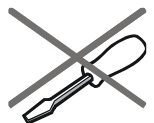

Waste Disposal

Instructions for Waste Disposal

- Packaging and packaging aids are recyclable and should principally be recycled. Packaging materials, such as foil bag, must be kept away from children.
- Batteries, including those which are heavy metal-free, should not be disposed of with household waste. Please dispose of used batteries in an environmentally friendly manner. Find out about the legal regulations which apply in your area.
- Cold cathode fluorescent lamp in LCD PANEL contains a small amount of mercury; please follow the local laws or regulations for disposal.

Information for Users in European Union Countries



The mark  is in compliance with the Waste Electrical and Electronic Equipment Directive 2002/96/EC (WEEE).

 The mark indicates the requirement NOT to dispose the equipment including any spent or discarded batteries as unsorted municipal waste, but use the return and collection systems available. If the batteries or accumulators included with this equipment, display the chemical symbol Hg, Cd, or Pb, then it means that the battery has a heavy metal content of more than 0.0005% Mercury, or more than 0.002% Cadmium or more than, 0.004% Lead.

Disconnecting the Device

The mains plug is used to disconnect TV set from the mains and therefore it must remain readily operable.

Headphone Volume

Excessive sound pressure from earphones and headphones can cause hearing loss.



Installation

To prevent injury, this device must be securely attached to the wall in accordance with the installation instructions when mounted to the wall (if the option is available).

LCD Screen

The LCD panel is a very high technology product with about a million thin film transistors, giving you fine picture details. Occasionally, a few non-active pixels may appear on the screen as a fixed blue, green or red point. Please note that this does not affect the performance of your product.

Warning

Do not leave your TV in standby or operating mode when you leave your house.

Overview of the Remote Control

- ① Standby
- ② Direct Programme
- ③ External Source
- ④ Info
- ⑤ Programme Up / Programme Down
- ⑥ Okay / Freeze Picture
- ⑦ Cursor buttons
- ⑧ Menu
- ⑨ Green / Picture / Page Down
- ⑩ Red / Sound / Page Up
- ⑪ Time (in TXT mode) / Subtitle on-off
- ⑫ Teletext
- ⑬ Mix (in TXT mode) / No function
- ⑭ Image size / Expand (in TXT mode)
- ⑮ Previous Programme
- ⑯ Personal Preference
- ⑰ Reveal (in TXT mode) / Switch to PC Programme Guide (EPG)
- ⑱ Update (in TXT mode) / No function
- ⑳ Hold (in TXT mode) / No function
- ㉑ Blue / Install
- ㉒ Yellow / Feature
- ㉓ TV / Digital TV
- ㉔ Mono-stereo / Dual I-II
- ㉕ Volume + / Volume -
- ㉖ No function
- ㉗ Mute

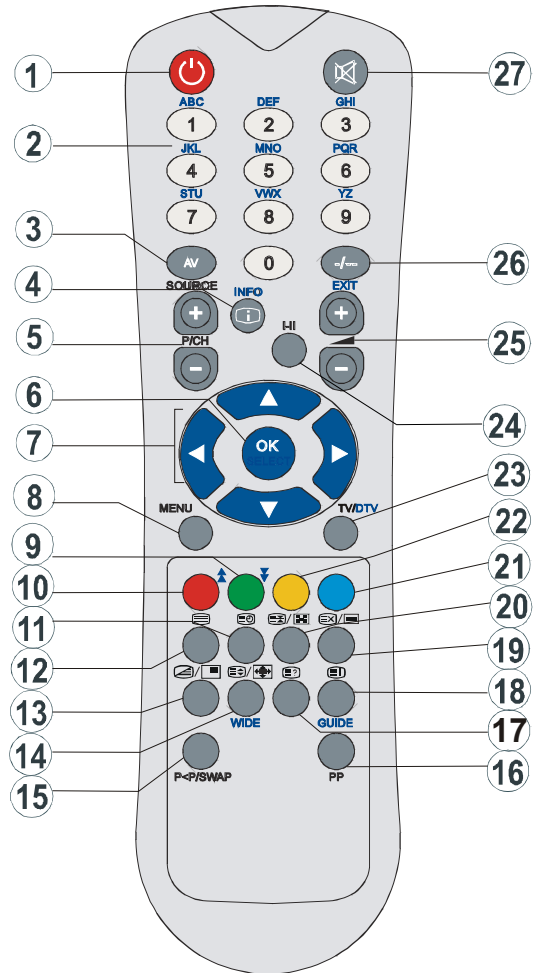

LCD TV and Operating Buttons

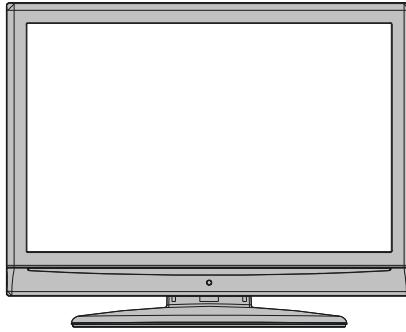

FRONT VIEW

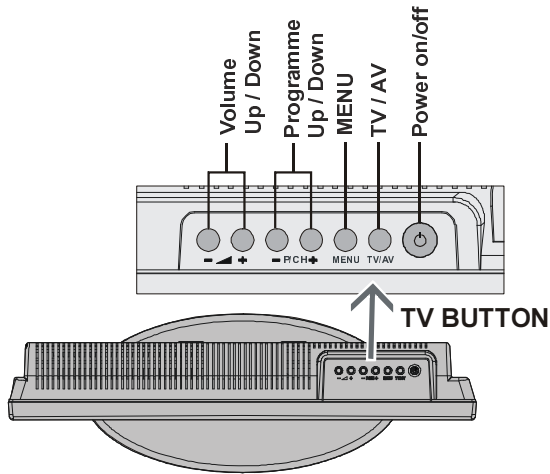

TOP VIEW

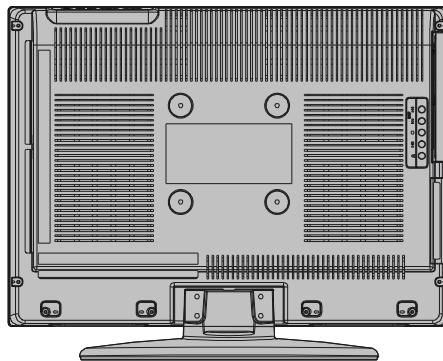

REAR VIEW

Viewing the Connections

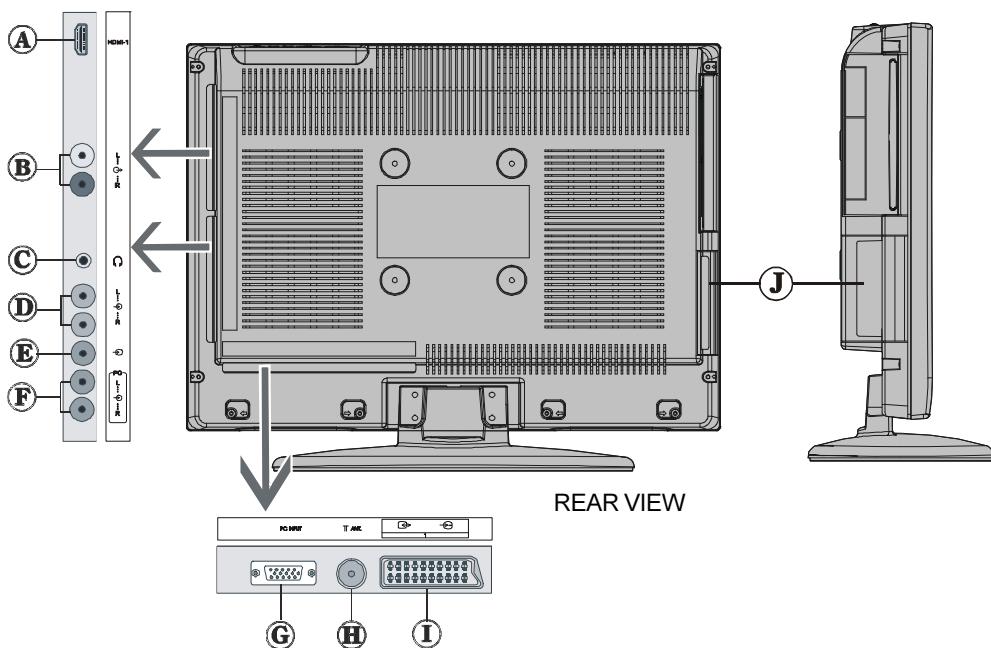

A HDMI Input are for connecting a device that has an **HDMI** socket.

Your LCD Television is capable of displaying High Definition pictures from devices such as a High Definition Satellite Receiver or DVD Player. These devices must be connected via the HDMI sockets or Component Socket. These sockets can accept either 720p or 1080i signals. No sound connection is needed for an HDMI to HDMI connection. If you use HDMI to DVI cable, use PC audio in input to enable sound connection.

B Audio Line Outs output audio signals to an external device such as an optional sound system.

C Headphone jack is used for connecting an external headphone to the system. Connect to the **HEADPHONE** jack to listen to the TV from headphones (optional).

D Audio Inputs are used for connecting audio signals of external devices.

Connect the audio cable between the **AUDIO INPUTS** on the TV and the **AUDIO OUTPUT** jacks on your device.

E Video Input is used for connecting video signals of external devices.

Connect the video cable between the **VIDEO IN** socket on the TV and the **VIDEO OUT** jack on your device.

F PC sound inputs: Connect the audio cable between the **PC SOUND INPUTS** on the TV and the **AUDIO OUTPUT** jacks on your PC.

Ⓒ **PC Input** is for connecting a personal computer to the TV set.

Connect the PC cable between the **PC INPUT** on the TV and the PC output on your PC. If you want to connect a device that has YPbPr, please use YPbPr to PC cable.

Ⓓ **RF Input** connects to an antenna or a cable.

Note: *that if you use a decoder or a media recorder, you should connect the aerial cable through the device to the television with an appropriate antenna cable.*

Ⓔ **SCART** inputs or outputs for external devices.

Connect the **SCART** cable between **SCART** sockets on TV and **SCART** socket on your external device (such as a decoder, a VCR or a DVD player).

Note: *If an external device is connected via the **SCART** socket, the TV will automatically switch to AV mode.*

Ⓕ **CI Slot** is used for inserting a CI card. A CI card allows you to view all the channels that you subscribe to. For more information, see "Common Interface" section.

Power Connection

IMPORTANT: The TV set is designed to operate on 220-240V AC, 50 Hz.

- After unpacking, allow the TV set to reach the ambient room temperature before you connect the set to the mains.
- Plug the power cable to the mains socket outlet.

Aerial Connection

- Connect the aerial or cable TV plug to the **AERIAL INPUT** socket located at the rear of the TV.

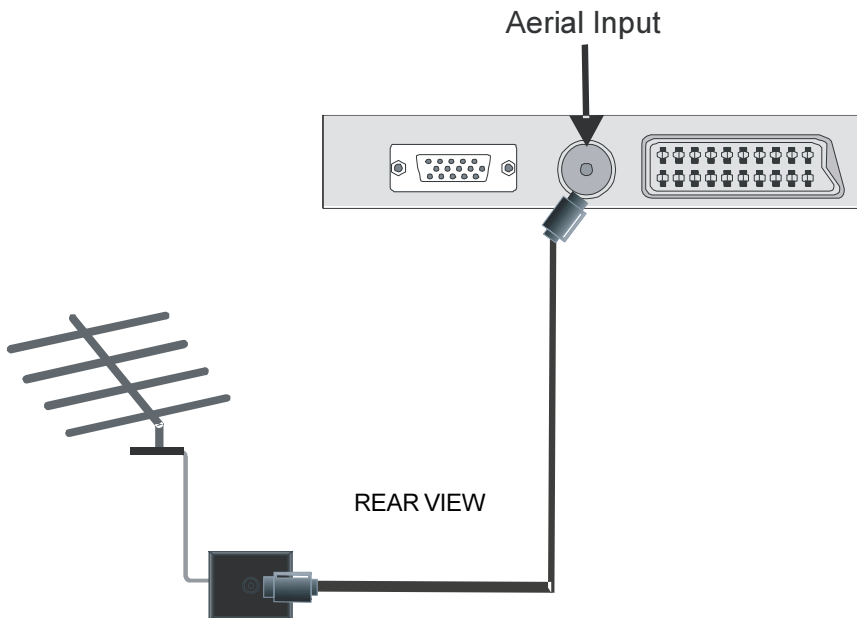

Connecting the LCD TV to a PC

For displaying your computer's screen image on your LCD TV, you can connect your computer to the TV set.

- Power off both computer and display before making any connections.
- Use 15-pin D-sub display cable to connect a PC to the LCD TV.
- When done, switch to PC source. See, “**Input selection**” section.
- Set the resolution that suits your viewing requirements.

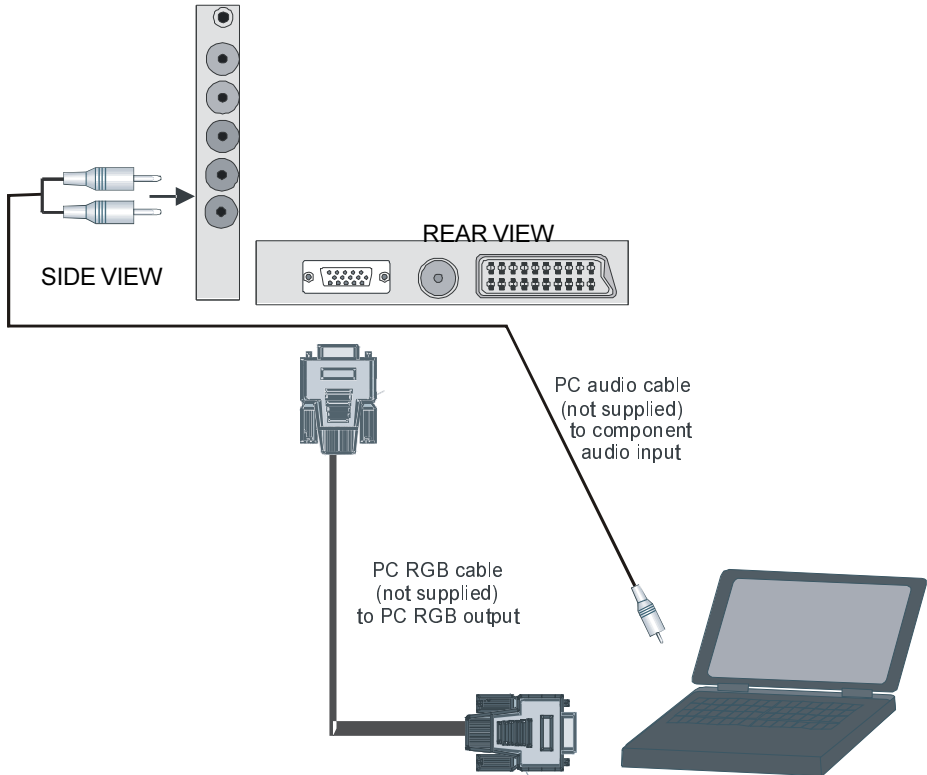

Connecting an external DVD Player

If you want to connect a DVD player to your LCD TV, you can use connectors of the TV set. DVD players may have different connectors. Please refer to your DVD player's instruction book for additional information. Power off both the TV and the device before making any connections.

Note: Cables shown in the illustration **are not supplied**.

- If your DVD player has an **HDMI** socket, you can connect via **HDMI**. When you connect to DVD player as illustrated below, switch to HDMI source. See, “**Input selection**” section.
- Most DVD players are connected through **RCA SOCKETS**. Use a RCA video cable to connect video input. For enabling audio, use a component audio cable as illustrated below. When done, switch to **EXT2-** source. See, “**Input selection**” section.
- You may also connect through the **SCART** . Use a **SCART** cable as shown below.

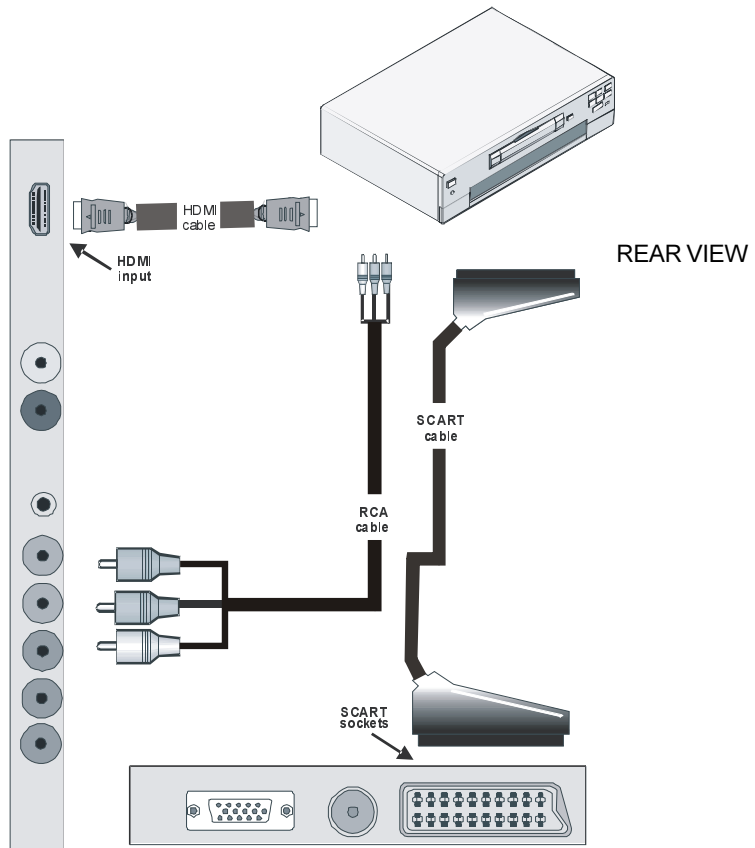

Note: These three methods of connection perform the same function but in different levels of quality. It is not necessary to connect by all three methods.

Using Other Connectors

You can connect a range of optional equipment to your LCD TV. Possible connections are shown below. *Note that cables shown in the illustration are not supplied.*

- For connecting a camcorder, connect to the **VIDEO IN** socket and the **AUDIO SOCKETS**.
- To connect external speakers; connect the audio output sockets on the TV to an external amplifier that is connected to a speaker system.
- To listen the sound from headphones, connect to the **HEADPHONE** jack of the TV.

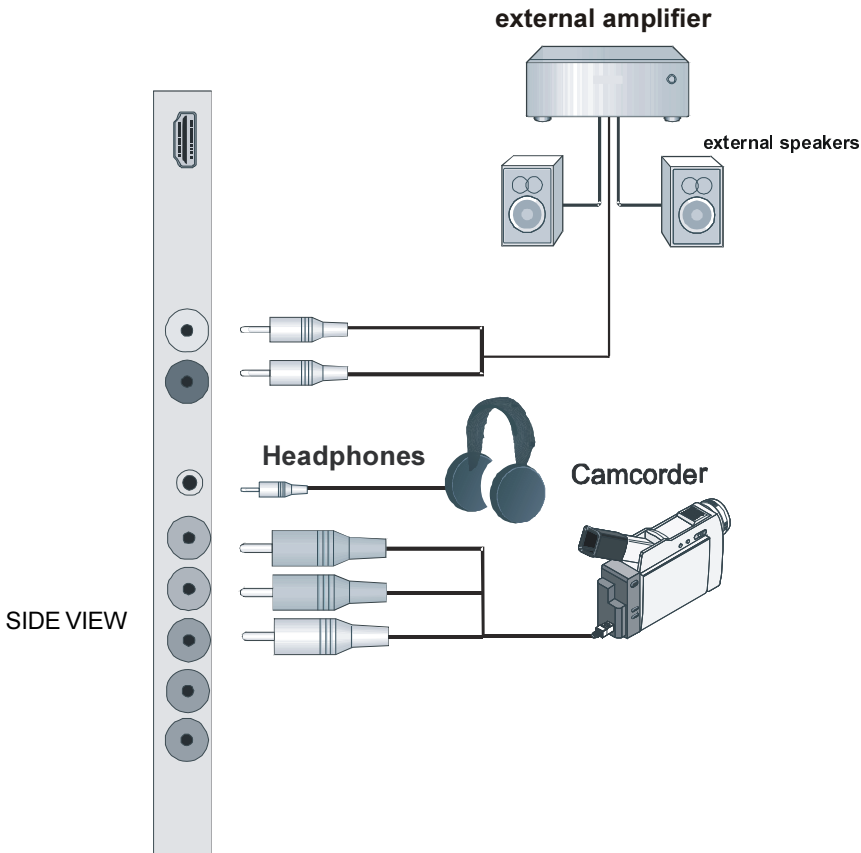

Connecting Other Equipment via Scart

Most devices support **SCART** connection. You can connect a; DVD recorder, a VCR or a decoder to your LCD TV by using the **SCART** sockets. *Note that cables shown in the illustration are not supplied.*

- Power off both the TV and the devices before making any connections.
- For more information, refer to your device's own instruction book.

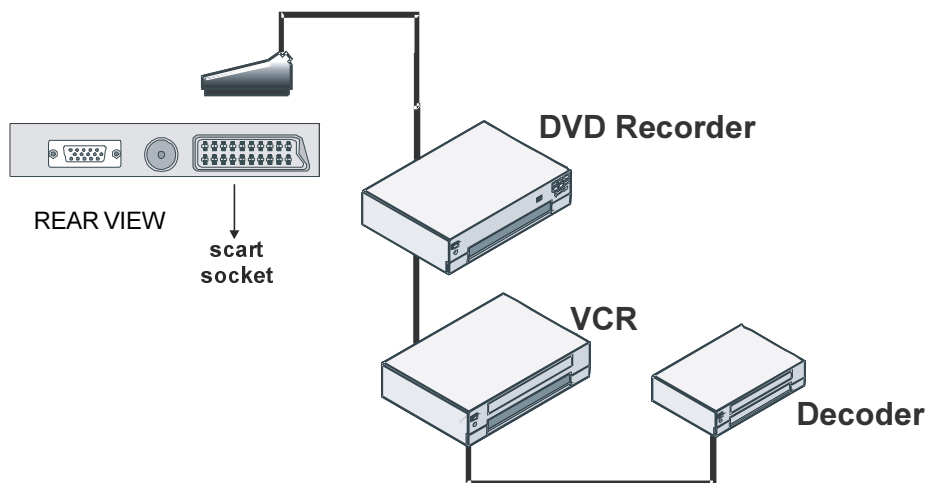

Inserting Batteries in the Remote Control Handset

- Remove the battery cover located on the back of the handset by gently pulling backwards from the indicated part.
- Insert two **AAA/R3** or equivalent type batteries inside. Place the batteries in the right directions and replace the battery cover.

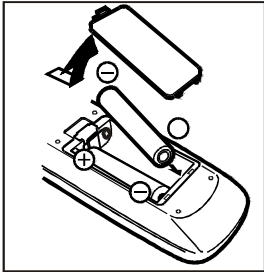

Handling the Remote Control

- Improper use could cause corrosion or battery leakage and may result in physical injury and/or property damage including fire.
- Never mix used and new batteries in the device.
- Replace all the batteries in a device at the same time.
- Remove the batteries if the remote control is not going to be used for an extended period of time.
- To avoid possible failure, read the following instructions and handle the remote control properly.
- Do not drop or cause impact to the remote control.
- Do not spill water or any liquid on the remote control.
- Do not place the remote control on a wet object.
- Do not place the remote control under the direct sunlight or near sources of excessive heat.

Note: Remove the batteries from remote control handset when it is not to be used for a long period. Otherwise, it can be damaged due to battery leakage.

Operating Range for the Remote Control

- Point the top of the remote control toward the LCD TV's remote sensor LED while pressing a button.

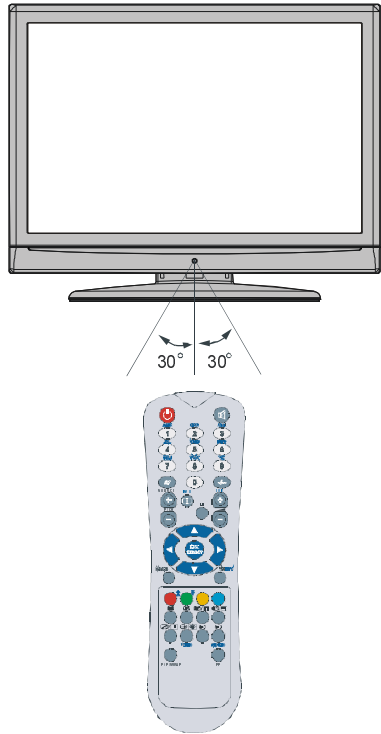

Remote range is approximately 7m/23ft.

Switching the TV On/Off

To Switch the TV On

- Connect the power cord to the 220-240V AC, 50 Hz.
- Press **STANDBY** button. Then the standby LED lights up.
- To switch on the TV from standby mode either:
 - Press the  button, **P+ / P-** or a numeric button on the remote control.
 - Press the **-P/CH** or **P/CH+** button on the TV. The TV will then switch on.

Note: If you switch on your TV via PROGRAMME UP/DOWN buttons on the remote control or on the TV set, the programme that you were watching last will be reselected.

To Switch the TV Off

- Press the  button on the remote control or **STANDBY** button on the TV, so the TV will switch to standby mode.
- To power down the TV completely, unplug the power cord from the mains socket.

Input Selection

Once you have connected external systems to your TV, you can switch to different input sources.

- Press the **AV** button on your remote control until the desired source is highlighted. The TV will then switch to the selected source after a short while.

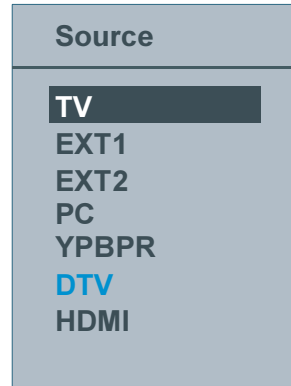

- Depending on your selection of working mode, the remote control buttons' functions will change accordingly.

Basic Operations

You can operate your TV using both the remote control and onset buttons.

Operation with the Buttons on the TV

Volume Setting

- Press **▲** - button to decrease volume or **▲** + button to increase volume, so a volume level scale (slider) will be displayed on the screen.

Programme Selection

- Press **P/CH +** button to select the next programme or **P/CH -** button to select the previous programme.

Entering Main Menu

- Press the **MENU** button to enter main menu. In the Main menu select sub-menu using **P/CH -** or **P/CH +** buttons and enter the sub-menu using **▲** - or **▲** + buttons. To learn the usage of the menus, refer to the menu system sections.

AV Mode

- Press the **TV/AV** button at the control panel on the the TV to switch your TV to AV modes.

Operation with the Remote Control

- The remote control of your TV is designed to control all the functions of the model you selected. The functions will be described in accordance with the menu system of your TV.
- Functions of the menu system are described in the following sections.

Volume Setting

Press **V +** button to increase the volume. Press **V -** button to decrease the volume. A volume level scale (slider) will be displayed on the screen.

Programme Selection (Previous or Next Programme)

- Press **P -** button to select the previous programme.
- Press **P +** button to select the next programme.



Programme Selection (Direct Access)

- Press numeric buttons on the remote control to select programmes between 0 and 9. The TV will switch to the selected programme. To select programmes between 10 - 999 (for IDTV) press the numeric buttons consecutively (e.g. for programme 27, first press 2 and then 7). Use **-/--** button to select programmes between 10-99 in analogue mode. When the pressing time is due for the second numeric button, only the first digit programme will be displayed. The limit of the delay time is 3 seconds.
- Press directly the programme number to reselect single digit programmes.

Initial Settings

When the TV set is operated for the first time, the IDTV turns on first.

Because this is the first time the TV is used, there are no channels stored in the memory and the following message appears on the screen:

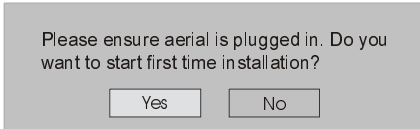

- To start installation process, select “**Yes**”, to cancel select “**No**”.
- To select the “**Yes**” or “**No**” option, highlight the item by using ◀ or ▶ buttons and press the **OK** button.

The IDTV will automatically tune to the UHF transmission channels 21 to 68, searching for digital terrestrial TV broadcasts and displaying the names of channels found. This process will take about five minutes. To cancel searching, you can press the **M** button at any time during the process.

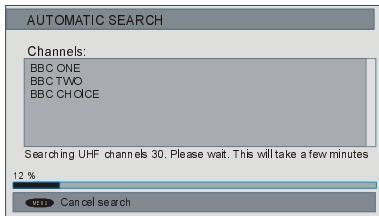

After **Automatic Search** is completed, the following message asking for analogue channel search appears on the screen:

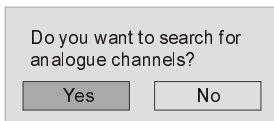

To search for analogue channels, select “**Yes**”. TV switches to the analogue TV mode. The menu below is displayed to search for analogue channels:

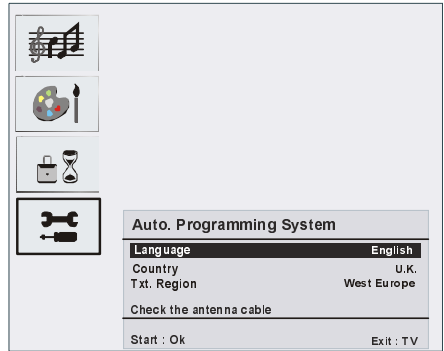

Set **Language** item by pressing ◀ or ▶ button. Press ▲ or ▼ button to highlight **Country** item and then use ◀ or ▶ to set. Press ▲ or ▼ button to highlight **Txt. Region**. Select a region by using ◀ or ▶ button. When finished, press **OK** button to continue. To cancel, press the **TV** button.

For more information on this process, see “**Install Menu**” section.

NOTE: For proper functioning of digital teletext in DTV mode, you should set **country** as UK in analogue APS.

General Operation

Pressing the TV or DTV button at any time while watching television programmes will switch the TV set between displaying the digital terrestrial television broadcasting and its normal analogue broadcasting.

Information Banner on DTV

- Whenever you change channel, using the **P-** / **P+** button or the numeric buttons, the TV displays the broadcast picture along with an information banner at the bottom of the screen. This will remain on the screen for approximately three seconds.
- The information banner can also be displayed at any time while watching TV by pressing the **i** button on the remote control:

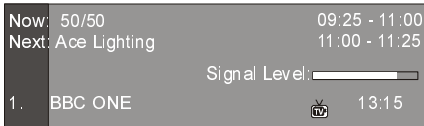

- The information banner gives information on the channel selected and the programmes on it. The name of the channel is displayed, along with its channel list number and an indication of the strength of the signal received.

Hint: Not all channels broadcast the programme data. If the name and time of the programme are not available, then “No Information Available” will be displayed in the information banner.

- Icons are also displayed in the information banner and if this channel is a favourite channel, favourite channel icon “😊” will also be displayed.

If the selected channel is locked, you must enter the correct four numeric code to view the channel. “Enter Lock Key” will be displayed on the screen in such a case:

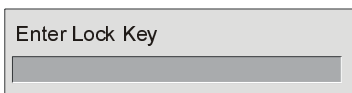

Electronic Programme Guide (EPG)

- Some, but not all, channels send information about the current and next events.
- Please note that event information is updated automatically. If there is no event information data available in channels, only channel names with “No Information Available” banner is displayed.
- Press **GUIDE** button to view the **EPG** menu.
- In EPG menu, you can easily see the extended help information by pressing **i** button.
- Press this button again to close this window.
- In the EPG menu, all channels are displayed.

Current channel is highlighted. Use **▲** or **▼** buttons to change channels. Also press **GREEN/RED** buttons to scroll up/down the pages for the channels.

- If you highlight an event; short event description, extended event description, start and end times of the event will be displayed on the screen.
- When the current programme is highlighted, the box is switched to the highlighted channel by pressing the **OK** button.
- If you press the **OK** button when a next event is highlighted, a reminder is set for the highlighted programme and a clock appears across the highlighted channel line.

Programme reminders can be set to signal that a programme is about to start when you are watching another channel. If you set reminder for a programme, then you will be asked for switching to that channel when the reminder time is reached.

- Press the **M** button to view the 7 day EPG.
- Press **▲** or **▼** button to navigate in Channels or Programmes.
- Press **◀** or **▶** button to navigate through the channel and programme list.

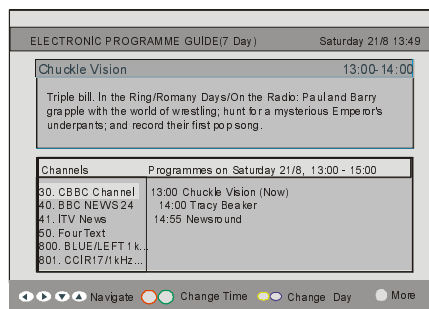

- With **RED/GREEN** buttons, you can change the schedule time. By pressing **YELLOW/BLUE** you can advance the schedule backward/forward of a day.

- If you press **(i)** button you can see the detailed help information easily. Press **(i)** button again to exit help menu.
- The starting time for **EPG** is the current time. You can see the event information for the next two hours. By pressing **◀** or **▶** button, you can go to the next/previous hours while Programmes list is highlighted.
- If you press the **OK** button when a next event is highlighted, a reminder is set for the highlighted programme and a clock appears on the screen.
- Programme reminders can be set to signal that a programme is about to start when you are watching another channel. If you set reminder to a programme, then you will be asked for switching to that channel when the reminder time is due.

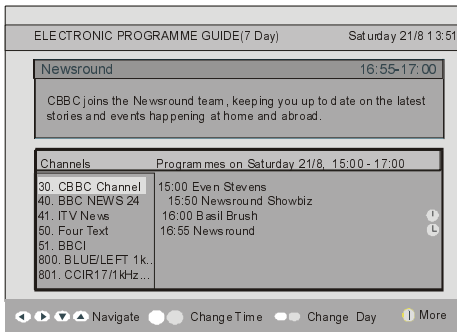

Displaying the Subtitles

With digital terrestrial broadcasting (DVB-T), some programmes are broadcast with subtitles. Subtitles can be displayed while watching these programmes.

Press the **M** button to display the main menu, highlight the **Configuration** line using **▲** or **▼** button and press the **OK** button to display the configuration menu.

Highlight the **“Subtitle”** item in configuration menu and use **◀** or **▶** button to set Subtitle to Off or a language.

If **“Subtitle”** is on and a language option is set, pressing the **(☰)** button causes the following warning message display on the screen:

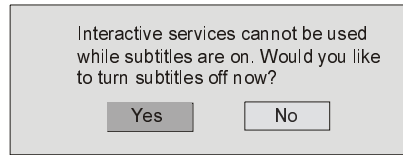

Digital Teletext

With digital terrestrial broadcasting (DVB-T), in addition to pictures and sound, you can also view digital teletext.

Digital teletext is sometimes broadcast at the same time with the normal broadcasting.

- Press the **(☰)** button.
- The digital teletext information appears.
- Operate it with the coloured buttons, **◀/▶/▼/▲** buttons and **OK** button.

The operation method may differ depending on the contents of the digital teletext.

Follow the instructions displayed on digital teletext screen.

- When **“Press SELECT”** button or similar message appears on the screen, press the **OK** button.
- When the **(☰)** (Text) button is pressed, the TV returns to television broadcasting.
- With digital terrestrial broadcasting (DVB-T), in addition to digital teletext broadcasting at the same time with the normal broadcasting, there are also channels with just digital teletext broadcasting.
- The aspect ratio when watching a channel with just digital teletext broadcasting is the same as the aspect ratio of the picture watched previously.
- When you press the **(☰)** (Text) button again, the digital teletext screen will be displayed.

Over Air Download

To ensure that your IDTV always has the most up-to-date information, please ensure that, after use, it is set to standby mode. At 3 A.M. each day, the IDTV automatically searches for any new information which may be broadcast and will download this to your IDTV automatically. This operation will normally take approximately 30 seconds.

If you want to perform this, you need to set Automatic Download to “**Enabled**” in Receiver Upgrade setting.

Widescreen

Depending on the type of the broadcast being transmitted, programmes can be viewed in a number of formats. Press the **WIDE** button repeatedly to select between **Auto**, **4:3**, **16:9**, **Cinema** or **Subtitle**.

When **Auto** is selected, the format being displayed is determined by the picture being broadcast.

PLEASE NOTE: *Menu size changes depending on the chosen image size.*

IDTV Menu System

The IDTV menu can only be viewed when watching digital terrestrial broadcasting. Press the DTV button to turn IDTV on while the TV is in analogue mode.

Press the **M** button. The menu below appears on the screen:

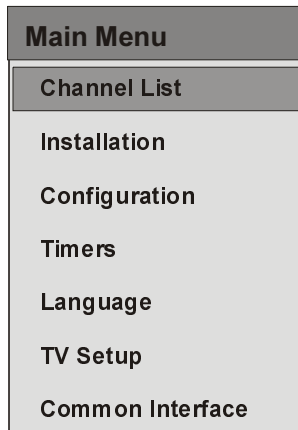

Channel List

Using the **▲** or **▼** button on the remote control, make sure that the first item, Channel List, is highlighted and press the **OK** button to display the **Channel List**.

The following operations can be performed in this menu:

- Navigating the entire list of channels
- Deleting channels
- Renaming channels
- Adding locks to channels
- Setting favourites

Channel List is the place where the channels are managed.



Navigating the Entire Channel List

Press **▲** or **▼** button for selecting the previous or next channel. You can press **RED** or **GREEN** button to move page up or page down.

To watch a specific channel, highlight it using **▲** or **▼** button and then press **OK** button, while the **“Select”** item on Channel List menu is highlighted by using **◀** or **▶** button.

Then the name and number of the selected channel will be displayed in the top-left and top-right of the channel display at the top-right of the screen, respectively.

Deleting the Channels in the Channel List

Press **▲** or **▼** button to select the channel that will be deleted.

Press **◀** or **▶** button to select the **“Delete”** item on Channel List menu. As seen on Channel List menu, **SELECT** is displayed next to **Delete** item at the bottom of the screen to indicate that you must press the **OK** button to delete the highlighted channel in the channel list.



Press the **OK** button to delete the highlighted channel in the channel list. Then the message below appears on the screen:

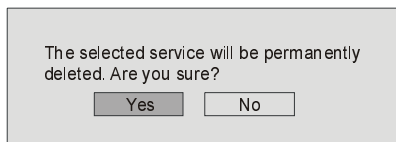

Press **◀** or **▶** button to highlight the desired option. If **OK** button is pressed while **“Yes”** is highlighted, the highlighted channel is deleted. Selecting **“No”** cancels the deletion.

Renaming Channels

To rename a specific channel, the channel must be highlighted by pressing **▲** or **▼** button. Then highlight the **Edit Name** item by pressing **◀** or **▶** button as illustrated below. Press the **OK** button to activate the rename feature.



Now pressing **◀** or **▶** button moves to the previous/next character. Pressing **▲** or **▼** button toggles the current character, i.e., **‘b’** character becomes **‘a’** by **▼** and **‘c’** by **▲**. Pressing the numeric buttons **‘0...9’** replaces the highlighted character with the characters printed above the button one by one as the button is pressed.

Press the **M** button to cancel the editing or **OK** button to save the new name.

Adding Locks to Channels

Channel locking provides a password-

protected access to channels selected by parents. In order to lock a channel you should know the parental lock password (default value is set to 0000 in the factory and can only be changed from the **Configuration** menu).

Select the channel to be locked by highlighting it and select the **Lock** option by pressing ◀ or ▶ button. When the **OK** button is pressed, a dialog OSD asking for the password will be displayed.

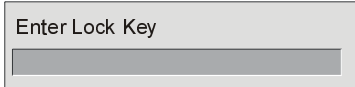

Enter the password by using the numeric buttons on the remote control. The lock icon  will now be displayed next to the selected channel. Repeat the same operation to cancel the lock.

Setting Favourites

You can set various channels as favourites so that only the favourite channels are navigated. To set a favourite you should highlight the **Favourites** item at the bottom of the Channel List menu.

Use the ◀ or ▶ button to highlight the **“Favourites”** item at the base of the screen and then, in turn, highlight each channel you want to add to the favourites list, using the ▲ and ▼ buttons (or red/green buttons), and press the **OK** button.

A channel selected as a favourite appears in

the main channel list with a favourites icon (😊) against the channel name as illustrated below:

NB. favorite mode needs to be activated in the configuration menu.

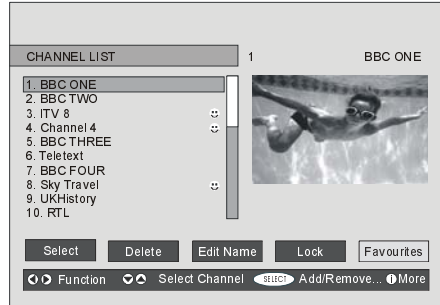

On Screen Help

For all menus, press the  button to display the help information about the menu functions.

For **Channel List** menu the following message is displayed on the screen:

Press the SELECT button on your remote control to tune to the highlighted channel.
Press MENU to exit this screen.

Installation

The Installation menu is mainly intended to help you for creating a **Channel Table** in the most efficient way.

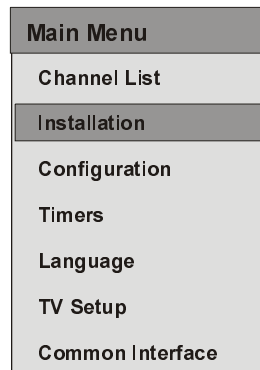

This menu includes the following items:

- Add New Channels.
- First Time Installation.

Add New Channels

This tuning menu consists of two parts:

- Automatic Search
- Manual Search



Automatic Search

Automatic search is started by pressing the **OK** button in the auto-search pop up menu. All the services will be searched and a channel table will be created automatically.

All channels found are stored in a sorted form with respect to their channel numbers. Some services may not appear with the correct channel number. If the broadcaster has no channel information, this may happen due to missing info.

Manual Search

In manual search, the number of the multiplex is entered manually and only that multiplex is searched for the channels. For every valid channel number, signal level, signal quality and network name are shown at the bottom of the screen.

In both manual and auto search, any existing channel in the database is not re-stored to avoid redundant duplicates of that channel.

First Time Installation

The user can use this item to load default settings, which were loaded to the receiver at the factory.

To install factory settings, highlight "**First Time Installation**" menu and press the **OK** button.



Then you will be asked to confirm for deleting all channels and settings:

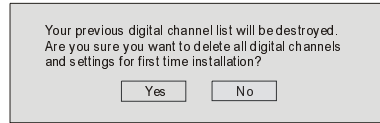

By selecting **Yes** and pressing the **OK** button, the existing channel table will be deleted.

After factory settings are loaded, "**First Time Installation**" menu will be displayed:

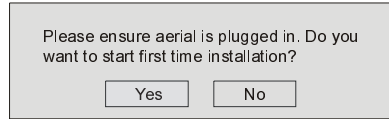

Press the **OK** button to start installation. After search is completed for digital channels, a message asking whether to search for analogue channels appears on the screen:

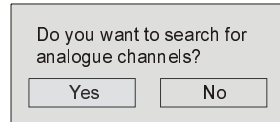

Press the **OK** button to search for analogue channels. The following menu appears on the screen for analogue channel search:

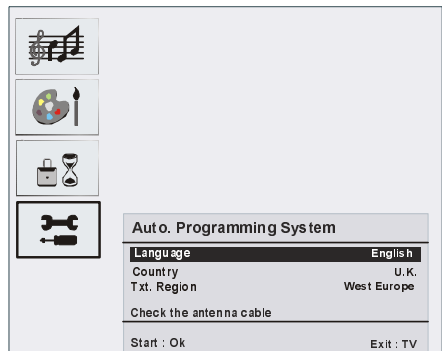

Set **Language** item by pressing **◀** or **▶** button. Press **▲** or **▼** button to highlight **Country** item and then use **◀** or **▶** to set. Press **▲** or **▼** button to highlight **Txt. Region**. Select a region by using **◀** or **▶** button. When finished, press **OK** button to continue. To cancel, press the **TV** button. The following menu will be displayed during the APS process:

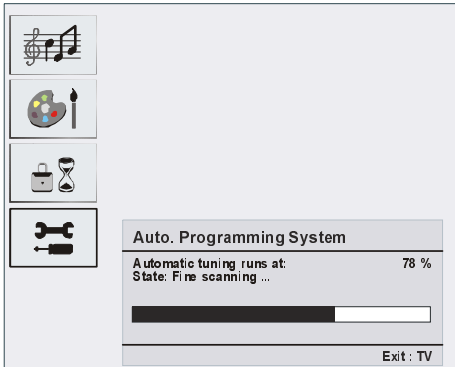

After APS is finalized, the programme table will appear on the screen. In the programme table you will see the programme numbers and names assigned to the programmes.

If you do not accept the locations and/or the programme names, you can change them in the programme table.

Configuration

Press the **M** button to display the main menu and press the **▼** button twice to highlight Configuration. Then press the **OK** button to display the configuration menu. Press the **M** button to leave the menu screen.

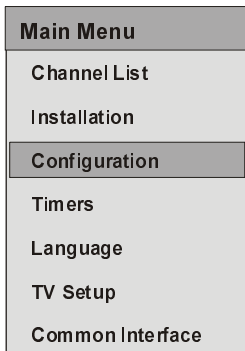

The various configuration functions are displayed in a list, along with a quarter-screen image of the currently selected channel. You can select a function by highlighting the corresponding menu line using the **▲** or **▼** button. Configuration menu will look like this:

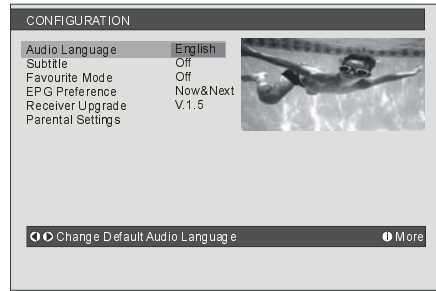

Audio Language

Digital terrestrial television channels can broadcast simultaneous soundtracks in more than one language. This function selects which language soundtrack you will hear when switching to a channel broadcasting with the multiple soundtracks.

Highlight the **Audio Language** line in the **Configuration** menu and use the **◀** or **▶** button to cycle through the language options.

Subtitle

Digital terrestrial television channels can broadcast subtitles displayed on the screen for hard-of-hearing people. This function selects the desired subtitle language and enables the automatic display of subtitles whenever subtitle information is broadcast.

Highlight the **Subtitle** line in the Configuration menu and use the **◀** or **▶** button to cycle through “Off” and language options.

Favourite Mode

This function enables or disables the favourite channel list mode.

Use **◀** or **▶** button to turn on/off favourite mode. If the “Favourite Mode” is on; while in normal operating mode, pressing **P+** and **P-** buttons will only navigate through the channels that were previously defined as favourites in the channel list.

EPG Preference

Digital terrestrial television channels can

broadcast simultaneous Next&Now and 7-Day electronic programme.

Highlight the EPG Preference line in the **Configuration** menu and use the ◀ or ▶ button to select **Next&Now** or **7-Day**.

Receiver Upgrade

The IDTV can be upgraded via the configuration menu, entered from the main menu.

In the configuration menu, highlight the **“Receiver Upgrade”** item by pressing ▲ or ▼ button and press the **OK** button to start upgrade process.

There are two possibilities for receiver software to be upgraded: **automatic** and **manual**.

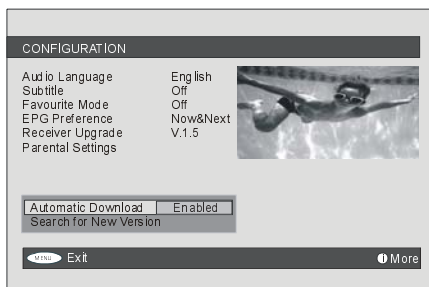

Automatic Download (Automatic Upgrade)

Automatic Download can be enabled or disabled by pressing ◀ or ▶ button. If it is enabled, then there are two ways for automatic upgrade:

- The first one is checking the existence of a new software every time the IDTV goes to standby.
- The second one is being activated at 03:00 A.M. every night, provided that the IDTV is left in standby mode.
- Both automatic upgrade methods result in standby mode either the upgraded or not.

If the automatic upgrade is set to **“Disabled”** then this function will not work.

Search for New Version (Manual Upgrade)

Manual upgrade starts if the **“Search for New Version”** item is highlighted by using ▲ or ▼ button and activated via pressing the **OK** button.

After **“Search for New Version”** is activated, the IDTV tunes to each frequency that have been stored in its database and looks for the new software. During this process, the following OSD is displayed:

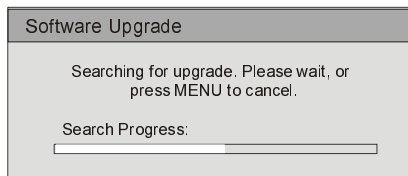

Parental Settings

Some channels broadcast material which you do not want younger members of the family to watch. Any channel can be 'locked' so that it cannot be selected for viewing unless a four-digit PIN code is entered. In this way, any channel not suitable for younger viewers can be prohibited.

This function enables or disables the menu protection system and allows the PIN code to be changed.

Use ▲ or ▼ button to highlight **Parental Settings** option. Press the **OK** button to enter Parental Settings menu. A dialog box asking for the lock key is displayed:

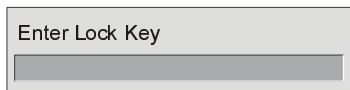

There is only one key which is set to **“0000”** initially. Enter lock key. If wrong lock key is entered, the following message is displayed and the TV then returns to the previous menu:

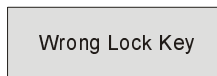

If it is correct, the **Parental Settings** menu will be displayed including the following items:

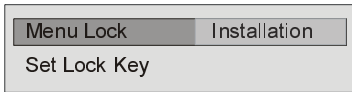

There you can set/reset locking for the main menu or the installation menu to restrict access. If the menu lock is disabled, there will be free access to the menu system. Also in this menu you can change the lock key and set/change parental lock mode.

Disabled: All menus are unlocked.

Main Menu: Main menu is accessible only with the correct lock key. So the user cannot add, delete, rename, move channels, cannot set timers.

Installation: Installation menu is locked, so the user cannot add channels.

Note: Changes will be updated after exiting configuration menu.

Timers

You can set a timer to switch the TV to any channel without your intervention. This is also for making video recordings of programmes when you are out.

Display the main menu by pressing the **M** button. Highlight the **Timers** line by pressing **▲** or **▼** button and press the **OK** button to display the Timer menu:

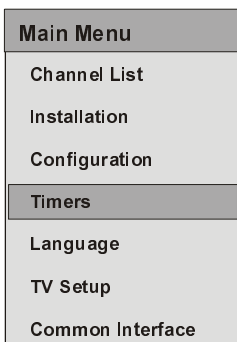

Up to five separate timer events can be set and each is displayed in the Timer screen, showing the event number, the channel to be selected, the start time, end time, date and the mode - whether that event is active (and will be acted on) or not.

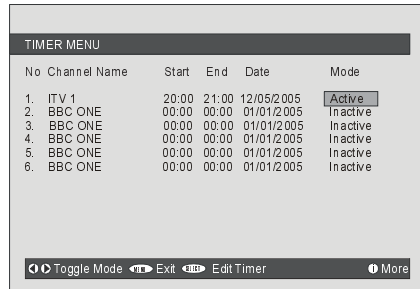

- To set an event, highlight its mode button using the **▲** or **▼** button and press the **OK** button to display the timer entry window.

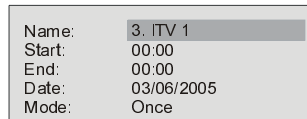

- Here the five settings consisting of the channel name, start time, end time, date and frequency mode can be set. You can move freely between each setting using the **▲** or **▼** buttons.
- The channel name is set using the **◀** or **▶** button to display the channel which broadcasts the programme.
- The start time, end time and date are each set with the numeric buttons on the remote control in 24-hour format.
- The frequency mode determines how often the receiver operates this event and is set with the **◀** or **▶** button to be either **Once**, **Daily**, or **Weekly**.

If an invalid number for the start or end times or the date is entered, "**Entered time is not valid**" message appears on the menu screen.

If timer action occurs while the TV is being watched, the TV switches to the selected channel. When timer expires, the TV switches back to the channel which it is switched from.

Language

Some programmes are broadcast in two or more languages simultaneously. The language thus can be selected from the Language menu.

- Press the **M** button to display the main menu and use **▲** or **▼** button to highlight the Language line and press the **OK** button:



- Use the **▲** or **▼** button to highlight the soundtrack language required and press the **OK** button. Normal viewing, with the required language soundtrack, can be resumed by pressing the **M** button.

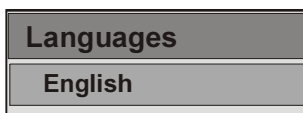

TV Setup

You can use this item to display the TV functions.

The digital TV Setup menu screen is accessed from the main menu. Press the **M** button to display the main menu and use **▲** or **▼** button to highlight “**TV Setup**”, press the **OK** button to display TV Setup menu screen.

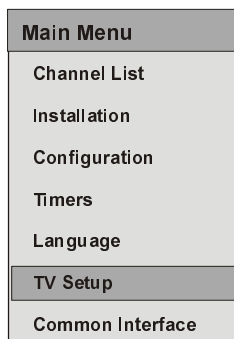

You can find detailed information for all menu items in “Analogue TV Menu System” section.

Common Interface

- Press the **M** button to display the main menu and use the **▲** or **▼** button to highlight the “**Common Interface**” line and press the **OK** button:

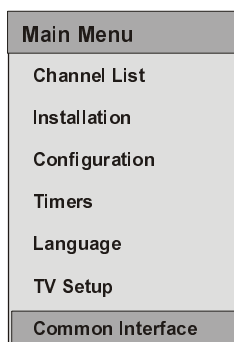

It is required to subscribe to a pay channel company to view the pay channels of the digital terrestrial broadcasting.

Obtain the Conditional Access Module (CAM) and the viewing card by subscribing to a pay

channel company, then insert those to the TV using the following procedure.

- Switch off the TV and unplug from the mains.
- Insert the CAM, then viewing card to the slot that is located in the terminal cover at the left-hand side of the TV (from front view).
- The CAM should be correctly inserted, it is impossible to insert fully if reversed. The CAM or the TV terminal may be damaged if the CAM is forcefully inserted.
- Connect the TV to the mains supply, switch on and then wait for few moments until the card is activated.
- Some CAMs may require the following set up. Please set the CAM by entering the IDTV menu, Common Interface then pressing the **OK** button. (CAM set up menu is not displayed when it is not required.)
- To see the viewing contract information: enter IDTV; press the **M** button, then highlight **Common Interface** and press the **OK** button.
- When no module is inserted, “**No Common Interface module detected**” message appears on the screen.
- Refer to the module instruction manual for details of the settings.

NOTE: Insert or remove the CI module only when the TV is in **STAND-BY mode** or **SWITCHED OFF**.

Navigating the Analogue TV Menu System

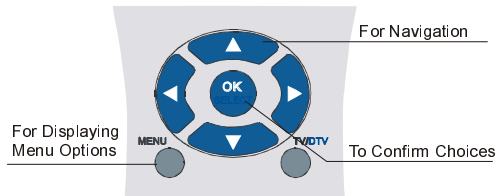

- Press **MENU** to display the main menu.
- Press **▲** or **▼** button to select an icon. Press **▶** or **OK** button for more options.
- Use **▲** or **▼** button to highlight.
- Press **◀** or **▶** buttons to change the settings. Press **OK** to set as default.
- To exit the menu or return from sub-menu screen, press **MENU**.

Note: *These explanations are valid for the navigation of the whole menu system. To select options that are explained in the following parts, refer to “Navigating the Analogue TV Menu System”.*

Analogue TV Menu Map

1

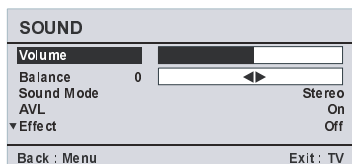

2

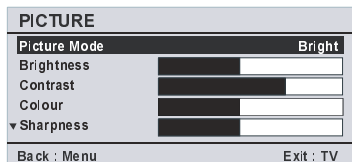

3

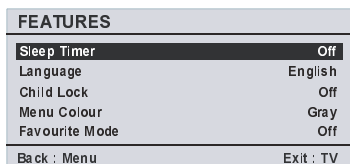

4

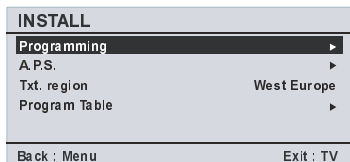

1 SOUND MENU

- Volume
- Balance
- Sound Mode
- AVL
- Effect
- Equalizer
 - Mode
- HP Volume
- Store

2 PICTURE MENU

- Picture Mode
- Brightness
- Contrast
- Colour
- Sharpness
- Colour Temp
- Room Lighting
- Picture zoom
- Store

3 FEATURES MENU

- Sleep Timer
- Language
- Childlock
- Menu Colour
- Favorite Mode

4 INSTALL MENU

- Programming
 - Programme
 - Band
 - Channel
 - Standard
 - Colour System
 - Search
 - VCR Mode
 - Decoder
 - Store
- APS
 - Auto Programming System
- Txt. Region
- Program Table

A menu map is provided above. For details of the items, refer to relevant explanations in the "MENU SYSTEM".

Analogue TV Menu System

Sound Menu

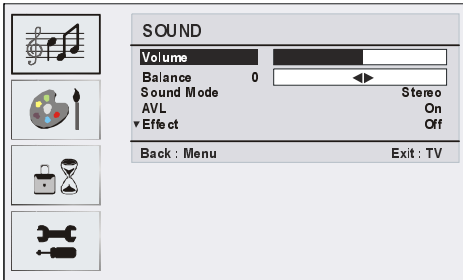

Volume

When you enter the sound menu, Volume will be the first selected option. Press ◀ / ▶ button to change the level of the Volume.

Balance

This setting is used for emphasizing the left or right speaker balance.

Press ▲ or ▼ button to select **Balance**. Press ◀ / ▶ button to change the level of the balance.

Balance level can be adjusted between **-32** and **+ 32**.

Sound Mode

Press ▲ or ▼ button to select **Sound Mode**. Using ◀ / ▶ button, you can select **Mono**, **Stereo**, **Dual I** or **Dual II** mode, only if the selected channel supports that mode.

AVL

Automatic Volume Limiting (AVL) function adjusts the sound to obtain fixed output level between programmes (For instance, volume level of advertisements tends to be louder than programmes). For getting a better sound quality, it is recommended that you set AVL function as On.

Press ▲ or ▼ button to select **AVL**. Press ◀ / ▶ button to set the AVL as On or Off.

Effect

If you are watching a mono broadcast, set

Effect on to obtain a better sound effect which will be more stereo-like. If the current sound system is stereo, switching this effect on will give a more spatial effect.

Press ▲ or ▼ button to select **Effect**. Press ◀ / ▶ button to set **Effect** as On or Off.

Equalizer

Press ▲ or ▼ button to select **Equalizer**. Press ◀ / ▶ button to change the Equalizer setting. In equalizer menu, the mode can be changed to **Flat**, **Speech**, **Music**, **Personal** and **Jazz**. Select the desired frequency by pressing ▼ / ▲ button and increase or decrease the frequency gain by pressing ◀ / ▶ button.

Note: Equalizer menu settings can be changed only when the mode is in Personal.

HP Volume

To adjust headphone volume level, press ▲ or ▼ button to select **HP Volume**. Press ◀ / ▶ button to change the level of the HP Volume.

Store

Select **Store** by pressing ▲ / ▼ button. Press ▶ or OK button to store the settings. "Stored" will be displayed on the screen.

Picture Menu

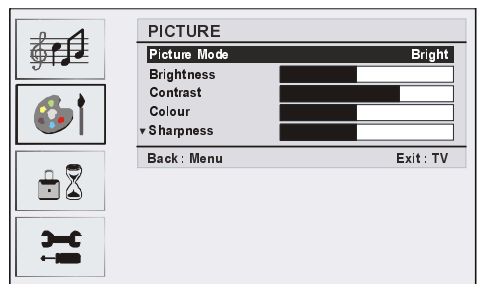

Picture Mode

For your viewing requirements, you can set the related **mode** option.

Press ▲ or ▼ button to select **Picture Mode**. Press ◀ or ▶ button to choose from one of these options: **Bright**, **Standard**, **Soft** and **Manual**.

Brightness/Contrast/Colour/Sharpness/Tint

Press ▲ or ▼ button to select the desired option. Press ◀ / ▶ button to set the level.

Hint: Tint (Hue) is displayed in picture menu when the TV receives an NTSC signal.

Colour Temp

Press ▲ or ▼ button to select **Colour Temp**. Press ◀ / ▶ to choose from one of these options: **Cool**, **Normal** and **Warm**.

Note:

- Setting **Cool** option gives white colours a slight blue stress.
- Setting **Warm** option gives white colours a slight red stress.
- For normal colours, select **Normal** option.

Room Lighting

Select **Room Lighting** by pressing the ▼ / ▲ button. Press ◀ / ▶ button to set Room Lighting as **Normal**, **Bright** or **Movie**.

Picture Zoom

Picture Zoom setting enables you to select the aspect ratio of the broadcast.

Select **Picture Zoom** by pressing ▼ / ▲ button. Use ◀ / ▶ buttons to change Picture Zoom to **Auto**, **4:3**, **16:9**, **Cinema** or **Subtitle**.

Store

Select **Store** by pressing ▲ / ▼ button. Press ▶ or **OK** button to store the settings. “**Stored**” will be displayed on the screen.

Features Menu

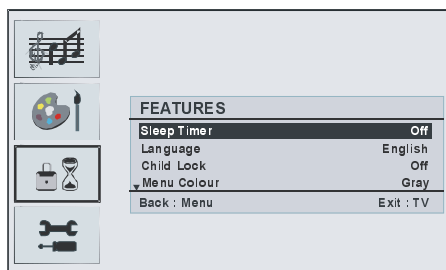

Sleep Timer

Press ▲ or ▼ button to select **Sleep Timer**. Use ◀ / ▶ button to set the **Sleep Timer**.

The timer can be programmed between **Off** and **120** minutes in steps of 10 minutes.

If **Sleep Timer** is activated, at the end of the selected time, the TV goes automatically to standby mode.

Language

Press ▲ or ▼ button to select **Language**. Use ◀ / ▶ button to select the **Language**.

Child Lock

Press ▲ or ▼ button to select **Child Lock**.

Use ◀ / ▶ button to set the Child Lock **On** or **Off**. When **On** is selected, the TV can only be controlled by the remote control handset. In this case the control panel buttons (except for the **STANDBY** button) will not work.

Hence, if one of those buttons is pressed, “**Child Lock On**” will be displayed on the screen when the menu screen is not visible.

Menu Colour

Press ▲ or ▼ button to select **Menu Colour**. Use ◀ / ▶ button to change menu background to **Transparent** or **Gray**.

Favourite Mode

Press ▲ or ▼ button to select **Favourite Mode**.

Use ◀ / ▶ button to set Favourite mode **On** or **Off** (See the “Program Table” section for details).

Install Menu

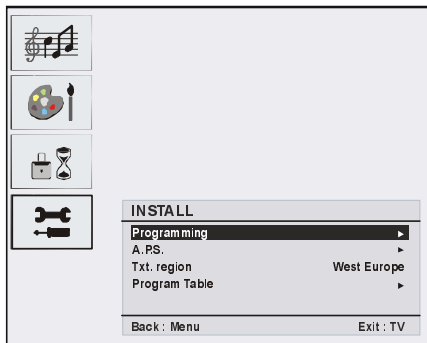

Programming

Select **Programming** by pressing ▼ / ▲ button. Then press ► button to display Programming menu:

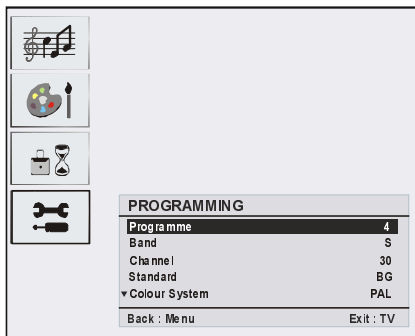

Programme

Select **Programme** by pressing ▼ / ▲ button. Press ◀ / ▶ button to select the programme number. You can also enter a number via the numeric buttons on the remote control. There are 100 programme storage between 0 and 99.

Band

Band can be selected either **C** or **S**. Press ◀ / ▶ button to select **Band**.

Channel

Select **Channel** by pressing ▼ / ▲ button. Channel can be changed by pressing ◀ / ▶ button or the numeric buttons.

Standard

Select **Standard** by pressing ▼ / ▲ button. Use ◀ / ▶ button to change the standard to **B/G**, **D/K**, **I** or **L/L'**.

Colour System

Select **Colour System** by pressing ▼ / ▲ button. Use ◀ / ▶ button to change the colour system to **PAL**, **SECAM** or **AUTO**.

Search

Select **Search** by pressing ▼ / ▲ button. Press ◀ / ▶ button to start search. The search will stop when a signal is found.

Note: If you press the buttons with one-step moves, a frequency of 0.25 Mhz will be advanced. However if you press the buttons for more than 3 seconds, it will advance automatically. To stop searching at a certain time, you may press ▼ / ▲ buttons.

VCR Mode

Select **VCR Mode** by pressing ▼ / ▲ button. Use ◀ / ▶ buttons to set VCR Mode as On or Off.

*Hint: If you want to watch a DVD , then you have to set this item as **Off**.*

Decoder

You can use this mode to connect any decoder to your TV.

Select **Decoder** by pressing ▼ / ▲ button. Press the ◀ / ▶ buttons to turn it On or Off.

When you switch the Decoder setting to **Off**, **EXT-1** output will be muted. In this case, **EXT-1** output will not be available to display video. If it is switched on, the **EXT-1** output will be the selected video source. Any decoder can be connected to **EXT-1** to unscramble required video signals.

Hint: Decoder setting should be stored separately for each programme.

Store

Select **Store** by pressing ▲ / ▼ button. Press ► or **OK** button to store the settings. "**Stored**" will be displayed on the screen.

A.P.S.

Select **A.P.S.** by pressing ▲ / ▼ button. Press ► button to enter the **A.P.S.** submenu:

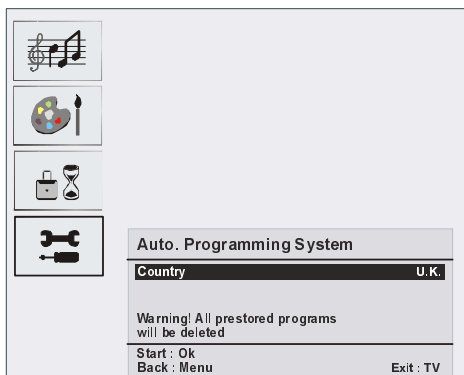

A.P.S. Country

Press ◀ / ▶ button to set your country.

If you want to exit from A.P.S. function, press the **TV** button. For going back, press **M**.

When you press **OK** button for starting APS, all stored programs will be erased and the following screen will be displayed:

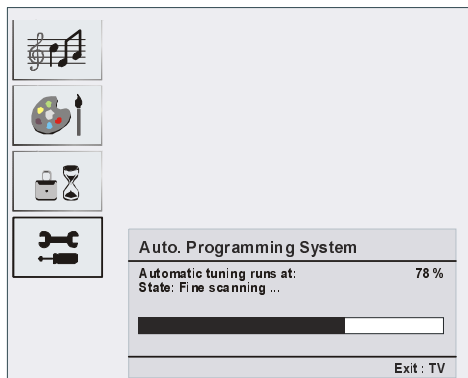

Whenever you press the **TV** button, A.P.S. function stops and program table appears on the screen.

If you wait until the end of A.P.S., Program Table is displayed with the programmes found and located.

Teletext Region

Select **Txt. region** by pressing ▲ / ▼ button. Using ◀ / ▶ buttons, select your teletext region. There are five options to select: **West Europe**, **East Europe**, **Turk/Gre**, **Cyrillic** and **Arabic/Hebrew**.

Install menu in AV modes

The following screen appears in the install menu:



Programming

Select **Programming** by pressing ▲ / ▼ button. After pressing ► button, programming menu appears on the screen:

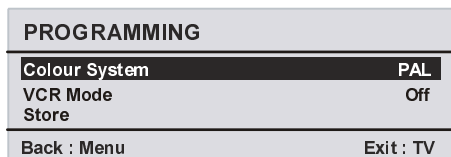

Colour System

Select **Colour System** by pressing ▲ / ▼ button. Press ◀ / ▶ button to change the colour system to **PAL**, **SECAM** or **AUTO**.

Program Table

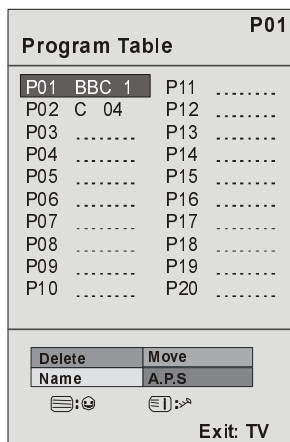

Program Table lists the channels that are stored in the memory. By moving the cursor in four directions, you can reach 20 programmes in the same page. You can scroll up or scroll down to see all the programmes while in TV mode by pressing the navigation buttons. By cursor action, programme selection is done automatically.

Name

To change the name of a programme, select the desired programme and press the **YELLOW** button.

The first letter of the selected name starts to blink. Press **▲** / **▼** button to change that letter and **◀** / **▶** button to select the other letters. By pressing the **YELLOW** button, you can store the name.

Move

Select the programme that you want to insert by using the navigation buttons. Press the **GREEN** button. Using navigation buttons, move the selected programme to the decided programme space and press the **GREEN** button again.

Delete

To delete a programme, press the **RED** button. Pressing the **RED** button again erases the selected programme from the programme list and the programmes below shift one line up.

APS (Auto Programming System)

When you press the **BLUE** button for APS, **Auto Programming System** menu will appear on the screen.

Favourite Mode

You can set various channels as favourites so that only the favourite channels are navigated. To set a favourite, use the navigation buttons to select a channel and then press the **☰** item. The channel selected as a

favourite appears in the Program Table with a favourites icon (☺) against the channel name. For removing a favourite, carry out the same operation. To exit, press **M**.

Program Lock

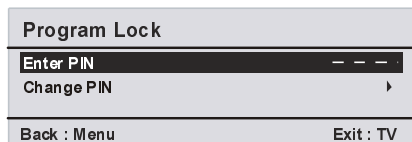

Program Locking provides a password-protected access to channels selected by parents. In order to lock a channel you should know the Program Lock password (default value is set to **0000** in the factory and can only be changed from the **Program Lock** menu).

Enter PIN

Select the channel that you desire to lock by highlighting it and then press the **☰** button. When the **☰** button is pressed, Program Lock menu will be displayed on the screen. After entering the pin code, desired channel will be locked. The program lock icon will appear next to the channel name. When the locked channel is selected through **P+** or **P-** buttons, the following warning screen will be displayed:

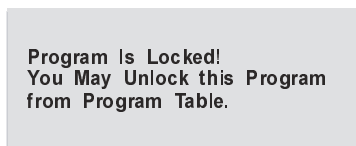

Change PIN

Select **Change PIN** by pressing **▼** / **▲** button. Use **▶** button to change the PIN code. After pressing **▶** button, the following message appears on the screen:

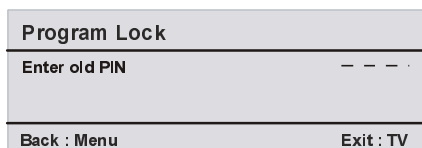

Enter old PIN code through the numeric buttons and then enter your new PIN code. Program Lock menu will be displayed on the screen when you enter the new PIN code:

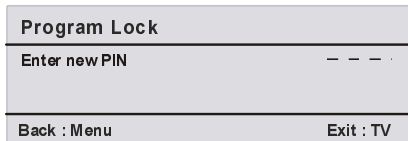

Program Lock Menu will again be displayed after a short while of the identification of new PIN.

Hint: If you forget your Program Lock password, you can deactivate the Program Lock by using the code 7910 and be able to set new password for future use. Thus, do keep this code in a safe place for future reference.

PC Mode Menu System

See the “**Connecting the LCD TV to a PC**” section for connecting a PC to the TV set.

For switching to PC source, press the **(AV)** button on your remote control and select PC input.

Note that PC mode menu settings are available only while the TV is in PC source.

Sound Menu

The items in this menu are described at “**Sound Menu**” section explained in the “Menu System” section.

Feature Menu

Feature menu settings are identical to the settings explained in “**Feature Menu**” section in the “Menu System” section.

PC Picture Menu

Select PC Picture menu by pressing **▲/▼** button and then press **▶** button. PC Picture menu appears on the screen. **Brightness**, **Contrast** and **Colour Temperature** adjustments in this menu are identical to adjustments defined in TV picture menu in “**Menu System**” part.

Geometry Menu

Select the fourth icon by pressing **▲/▼** button and then press **▶** button. Geometry menu appears on the screen:

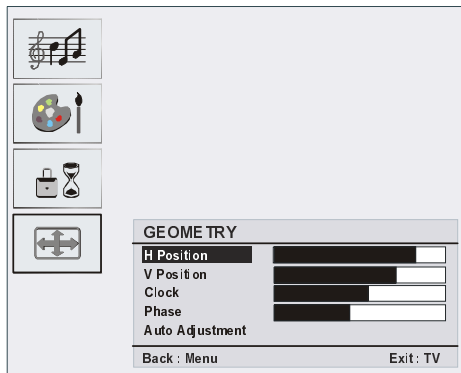

H. (Horizontal) Position

This item shifts the image horizontally to right hand side or left hand side of the screen.

Select **H. position** by pressing **▼ / ▲** button. Use **◀ / ▶** button to adjust the value.

V. (Vertical) Position

This item shifts the image vertically towards the top or bottom of the screen.

Select **V. position** by pressing **▼ / ▲** button. Use **◀ / ▶** button to adjust the value.

Clock

Clock adjustments correct interference that appear as vertical banding in dot intensive presentations like spreadsheets or paragraphs or text in smaller fonts.

Select **Clock** by pressing **▼ / ▲** button. Use **◀ / ▶** button to adjust the value.

Phase

Depending on the resolution and scan frequency that you input to the TV set, you may see a hazy or noisy picture on the screen. In such a case, you can use this item to get a clear picture by trial and error method.

Select **Phase** by pressing ▼ / ▲ button. Use ◀ / ▶ button to adjust the value.

Auto Adjustment

If you shift the picture horizontally or vertically to an unwanted position, use this item to put the picture into correct place automatically.

Select **Auto Adjustment** item by using ▼ / ▲ buttons. Press ▶ or OK button.

Warning: *Auto position adjustment recommended to be done with the full screen image for the proper adjustment.*

Displaying TV Information

Programme Number, **Programme Name**, **Sound Indicator** and **Zoom Mode** information are displayed on the screen when a new programme is entered or  button is pressed.

Mute Function

Press  button to disable sound. Mute indicator will be displayed in the upper side of the screen.



To cancel mute, there are two alternatives; the first one is pressing the  button and the second one is increasing the volume level.

Personal Preference

Press **PP** button to adopt the previous settings that you had stored before.

Zoom Modes

You can change the aspect ratio of the TV for viewing the picture in different zoom modes.

Press **WIDE** button to directly change the zoom mode. Available zoom modes are listed below:

Auto

When a **WSS (Wide Screen Signalling)** signal, which shows the aspect ratio of the picture, is included in the broadcast signal or

the signal from an external device, the TV automatically changes the **ZOOM** mode according to the **WSS** signal.

- When the **AUTO** mode does not function correctly due to poor **WSS** signal quality or when you want to change the **ZOOM** mode, change to another **ZOOM** mode manually.

4:3

Use to view a normal picture (4:3 aspect ratio) as this is its original size.



16:9

This uniformly stretches the left and right sides of a normal picture (4:3 aspect ratio) to fill the wide TV screen.

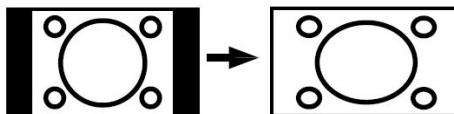

- For 16:9 aspect ratio pictures that have been squeezed into a normal picture (4:3 aspect ratio), use the **16:9** mode to restore the picture to its original shape.

Cinema

This zooms up the wide picture (16:9 aspect ratio) to the full screen.

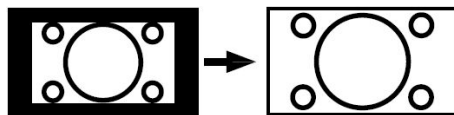

Subtitle

This zooms up the wide picture (16:9 aspect ratio) with subtitles to the full screen.

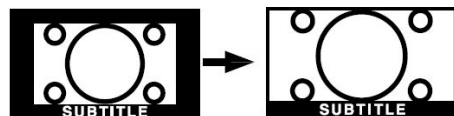

Teletext

Teletext system transmits information such as news, sports and weather on your TV. Note that if the signal becomes insufficient, some text errors may occur or the teletext mode may be quitted.

Teletext function buttons are listed below:



Teletext On-Off / PAT mode

Activates teletext mode when pressed once. Pressing this button again will split the screen into two windows, one displaying the teletext and the other displaying the current channel. Pressing again will quit the teletext mode.



Index

Selects the teletext index page.



Mix

Places the teletext screen over the programme.



Expand

Press once to enlarge top half of the page, press again to enlarge the bottom half of the page. Press again to revert back to normal size.



Reveal

Shows hidden information (e.g. solutions of games).



Hold

Holds a text page when convenient. Press again to resume.



Subcode Pages / Time

Selects subcode pages if available when the teletext is activated. When the teletext is not activated, displays time info if the programme has teletext transmission.

P+ / P- and numbers (0-9)

Press to select a page.

Note: Most TV stations use code 100 for their index pages.

Coloured Buttons

(RED/GREEN/YELLOW/BLUE)

Your TV supports both **FASTEXT** and **TOP text** systems. When these systems are available, the pages are divided into groups or topics.

When **FASTEXT** system is available, sections in a teletext page will become colour-coded and can be selected by pressing the coloured buttons. Press a coloured button that corresponds to with your needs.

The coloured writings will appear, showing you, which coloured buttons to use when **TOP text** transmission is present. Pressing **P -** or **P +** commands will request the next or previous page respectively.

Tips

Screen Care

Clean the screen with a slightly damp, soft cloth. Do not use abrasive solvents as they may damage the coating layer of the TV screen.

For your safety, unplug the mains plug when cleaning the set. When moving the TV, hold it properly from the bottom part.

Image Persistence

Please note that ghosting may occur while displaying a persistent image. LCD TVs' image persistence may disappear after a short time. Try turning off the TV for a while.

To avoid this, do not leave the screen in still picture for extended periods.

No Power

If your TV system has no power, please check the main power cable and connection to the mains socket outlet.

Poor Picture

Have you selected the correct TV system? Is your TV set or house aerial located too close to a non-earthed audio equipment or neon lights, etc.?

Mountains or high buildings can cause double pictures or ghost images. Sometimes you can improve the picture quality by changing the direction of the aerial.

Is the picture or teletext unrecognisable? Check if you have entered the correct frequency.

The picture quality may degrade when two peripherals are connected to the TV at the same time. In such a case, disconnect one of the peripherals.

No Picture

Is the aerial connected properly? Are the plugs connected tightly to the aerial socket? Is the aerial cable damaged? Are suitable plugs used to connect the aerial? If you are in doubt, consult your dealer.

No Picture means that your TV is not receiving a transmission. Have you selected the correct button on the remote control? Try once more.

Sound

You cannot hear any sound. Did you perhaps interrupt the sound, pressing the  button?

Sound is coming from only one of the speakers. Is the balance set to one extreme? See **Sound** menu.

Remote Control

Your TV no longer responds to the remote control. Perhaps the batteries are exhausted. If so you can still use the local buttons at the top of the TV.

Input Sources

If you cannot select an input source, it is possible that no device is connected.

Check the AV cables and connections if you have tried to connect a device.

CI Module

If you are experiencing a problem with the CI module, it is possible that CI module is not properly inserted. Remove the CI card and then reinsert.

If the problem persists, it is possible that your CI module is not recognized. Try inserting a different CI module.

Appendix A: PC Input Typical Display Modes

The display has a maximum resolution of 1360 x 768 (optional), frequency range of 56-75 Hz. The following table is an illustration of some of the typical video display modes.

Your TV may not support different resolutions. Supported resolution modes are listed below.

If you switch your PC to an unsupported mode, a warning OSD will appear on the screen.

Mode	Resolution		Frequency (Hz)	
	Horizontal	Vertical		
1	640	480	60	IBM, VGA
2	720	400	70	IBM, VGA
3	800	600	56	VESA
4	800	600	60	VESA
5	640	480	72	VESA
6	640	480	75	VESA
7	800	600	72	VESA
8	800	600	75	VESA
9	1024	768	60	VESA
10	1024	768	70	VESA
11	1024	768	75	VESA
12	1280	720	60	VESA
13	1280	768	60	VESA
14	1360	768	60	VESA

OPTIONAL

Specifications

DISPLAY

Size/Diagonal	19" (16:9 Display)
Viewable size / Diagonal	40.82 x 25.51 (cm) / 48.13 (cm)

VIDEO STANDARDS

Video	PAL/NTSC/SECAM
TV Tuner (Analog)	PAL/SECAM/B/G/D/K K'I/I' L/L' VHF (BAND I/II) UHF (BAND U) HYPERBAND CABLE TV (S1-S20 / S21-S41) 100 PRESET CHANNELS
TV Tuner (Digital)	MHEG-5 ENGINE compliant with ISO/IEC 13522-5 Ukengine Profile 1 Object carousel support compliant with ISO/IEC 135818-6 and UK DTT
Profile	Frequency range: 474-850 MHz Transmission standard: DVB-T, MPEG-2 FEC: all DVB modes Video: MP@ML, PAL, 4:3/16:9 Audio: MPEG Layer I&II 32/44.148KHz
Formats	Auto, 4:3, 16:9, Cinema or Subtitle

AUDIO

German + Nicam Stereo

INPUT CONNECTIONS

Video	TV Tuner: IEC 75 Ohm Input Resistance SCART: CVBS, RGB HDMI : x 1
-------	-------------------------------------------------------------------------

OUTPUT CONNECTIONS

Audio	Line Out: L/R phono sokets Headphones: 3.5mm Jack L/R
Audio Speaker Output	2 x 2W (RMS) (10% THD)

OPERATOR CONTROL KEYS

TV/AV, MENU, P/CH +, P/CH -, VOL +, VOL -, STANDBY.

OPERATING CONDITIONS

Temperature	0° ~ 40°C (in-operation)
Air Humidity	20% ~ 80% (no condensation)
Atmospheric Pressure	800 ~ 1114 Hpa

POWER SUPPLY

Voltage Supply	220-240VAC
Mains Frequency	50Hz
Power Consumption	60W, 1W Standby

DIMENSIONS AND WEIGHT

Display with stand D x L x H	155 x 457 x 365 (mm)
Display without stand: D x L x H	77 x 457 x 330 (mm)
Weight Display	5.0 kg
Weight Stand	0.75 kg
Weight (net)	5.75 kg

Pin Specifications

Signal Input

PC RGB Terminal (D-sub 15-pin connector)

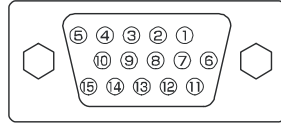

Pin	Input signal
1	R
2	G or sync on green
3	B
4	No connection
5	No connection
6	R.GND
7	G.GND
8	B.GND
9	No connection
10	GND
11	No connection
12	[SDA]
13	H.sync or H/V composite sync
14	V.sync. [V.CLK]
15	[SCL]

- When different kinds of input signals are simultaneously input to the monitor via a graphics board or the like, the monitor will automatically select the signals in the following priority order:

Sync signal type	Priority
H/V separate sync.	1
H/V composite sync.	2
sync.on Green *	3

- Even in the case of the recommended signals shown on the following page, there may be instances when correct display is not possible. In this case, use H/V separate sync, H/V composite sync.

HDMI connector pin specifications

Pin	Input signal	Pin	Input signal
1	TMDS Data2+	11	TMDS Clock Shield
2	TMDS Data2 Shield	12	TMDS Clock-
3	TMDS Data 2-	13	CEC
4	TMDS Data 1+	14	Reserved (N.C. on device)
5	TMDS Data1 Shield	15	SCL
6	TMDS Data1-	16	SDA
7	TMDS Data0+	17	DDC/CED Ground
8	TMDS Data0 Shield	18	+5V Power
9	TMDS Data0-	19	Hot Plug Detect
10	TMDS Clock+		

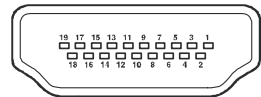

SCART connector pin specifications

Pin	Input signal	Pin	Input signal
1	AUDIO OUT (RIGHT)	12	Not used
2	AUDIO IN (RIGHT)	13	RGB-R GND
3	AUDIO OUT (LEFT/MONO)	14	GND
4	AUDIO GND	15	RGB-R / S.VHS CHROMINANCE IN
5	RGB-B GND	16	BLANKING SIGNAL
6	AUDIO IN (LEFT/MONO)	17	COMPOSITE VIDEO GND
7	RGB-B IN	18	BLANKING SIGNAL GND
8	AUDIO / RGB SWITCH / 16:9	19	COMPOSITE VIDEO OUT
9	RGB-G GND	20	COMPOSITE VIDEO / S.VHS LUMINANCE IN
10	Not used	21	GND / SHIELD (CHASSIS)
11	RGB-G IN		

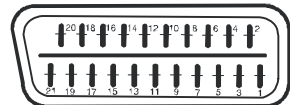

Product Guarantee

This product is guaranteed against manufacturing defects for a period of

1 Year

This does not cover the product where the fault is due to misuse, abuse, use in contravention of the instructions, or where the product has been the subject of unauthorised modifications or alterations, or has been the subject of commercial use

In the event of a problem with the product within the guarantee period please return it to your nearest store

If the item is shown to have had an inherent defect present at the time of sale, the store will provide you with a replacement

Your statutory rights remain unaffected

Guarantor; Home Retail Group
489 - 499 Avebury Boulevard
Central Milton Keynes
MK9 2NW

IMPORTANT - If placing TV into cabinet or alcove, ensure there is at least a 100mm (10cm) gap to the sides, rear and top of the TV. This is to allow for adequate ventilation during operation. Please read the main Users Guide for more safety information before installation.

1

insert the batteries into your handset

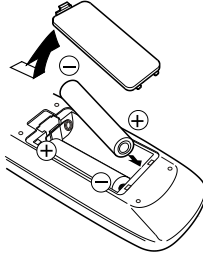

2a

either connect the aerial straight to your TV...

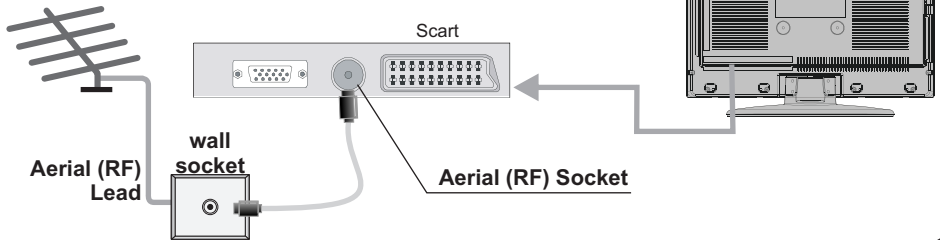

2b

...or connect the aerial through a VCR...

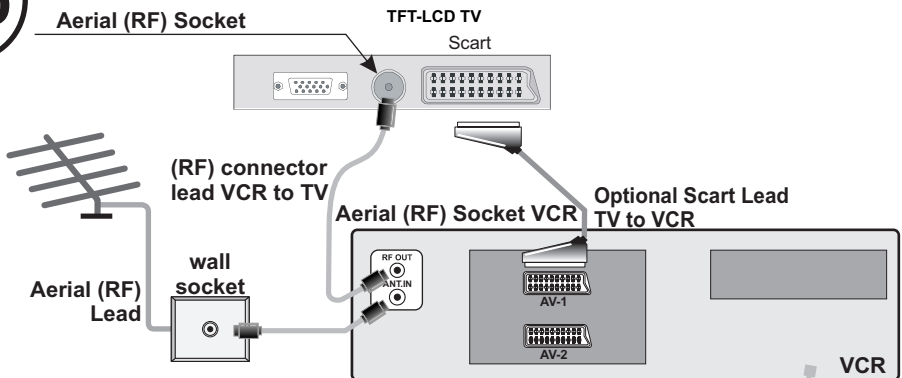

• It is recommended that a scart lead should be fitted between your TV and VCR to enhance your picture and sound quality. Scart leads are essential if you have a stereo TV and VCR and wish to obtain stereo sound from your equipment. These leads can be purchased from your Hitachi dealer or any good High Street electrical retailer.

2c

...or through a HDMI products (DVD-RW)

GB

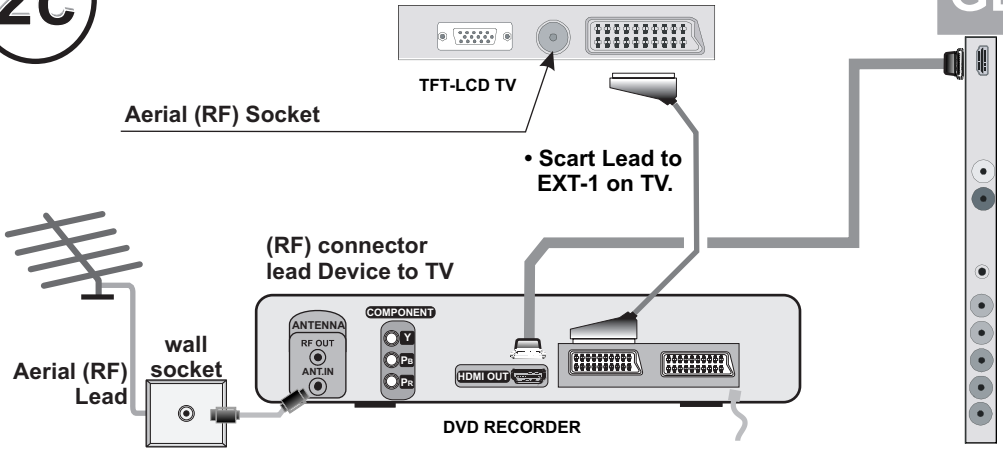

• High Definition

Your LCD Television is capable of displaying High Definition pictures from devices such as a High Definition Satellite Receiver or DVD Device. These devices must be connected via the HDMI socket or Component Socket. These sockets can accept either 720p or 1080i signals. Switch to these sources from the "Source Menu". Also 1080 progressive mode can be available if your TV model supports Full HD (Optional).

2d

...or through a VCR and satellite decoder.

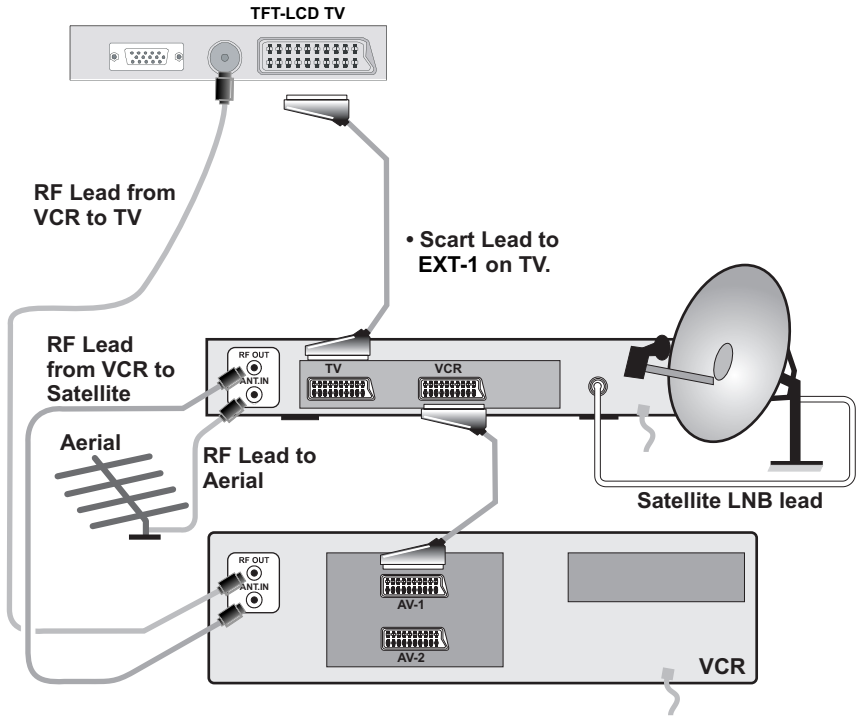

3

connect the TV plug to the mains socket

GB

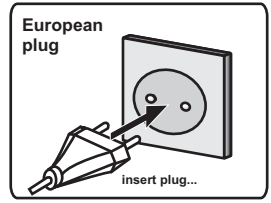
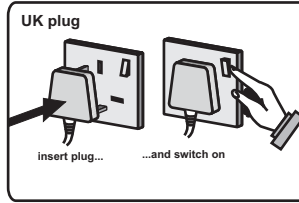
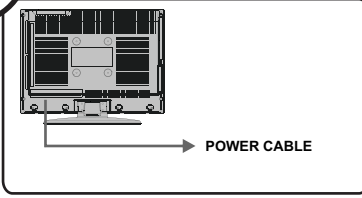

4

switch your TV on by pressing the On/Off button

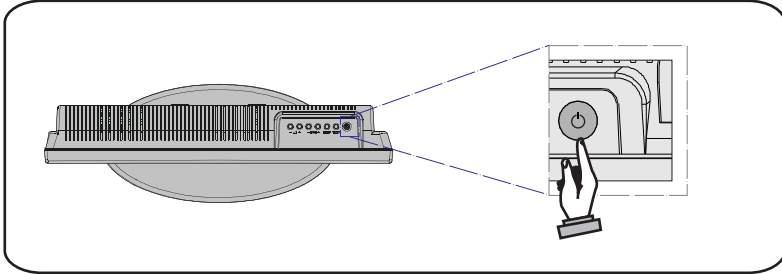

NB: When the set is first switched on, the set will be in standby and the indicator on the front of the set will illuminate red. Press the channel up down (P-, P+) or numeric buttons (1, 2, 3, ...) to operate.

basic functions of remote control

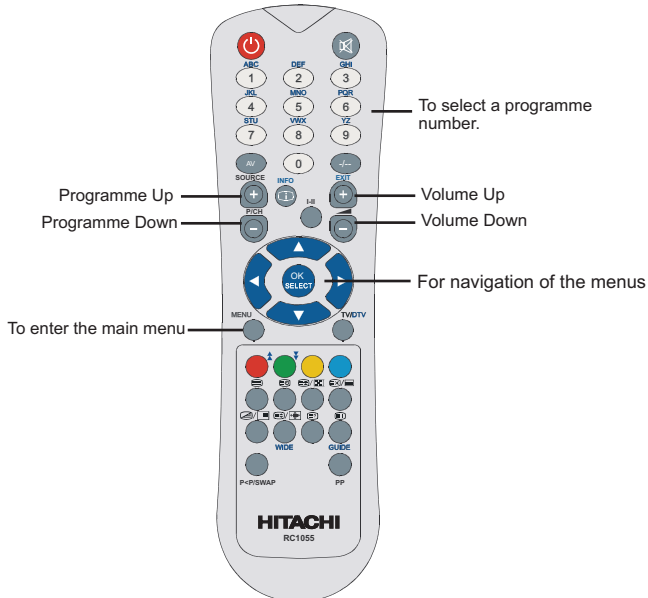

important note before starting Auto Setup

If you have a Video Cassette Recorder or a Satellite receiver connected to your TV please ensure that they are switched on before automatic tuning begins. In the case of a VCR, insert a pre-recorded tape and begin playback of your equipment. These measures ensure that all your external equipment is tuned in during the Auto Setup procedure.

5

start A.P.S. (Auto Programming System)

1

When the TV is turned on for the first time, it is in the digital mode. Because this is the first time the TV is used, there are no channels stored in the memory and the following message appears on the screen.

2

To start installation process, select "Yes", to cancel select "No". This process will take about five minutes. To cancel searching, you can press "M (MENU)" button at any time during the process.

3

After **Automatic Search** process is completed, a message asking for analogue channel search appears on the screen. To continue APS, first select the **Language, Country** and **TXT Region** by pressing ◀ / ▶ button and then press the "OK" button.

4

After APS is finalized, the programme table will appear on the screen. In the programme list you will see the programme numbers and names assigned to the programmes.

5

For details on the Program menu please refer to the Installation Menu section of the instruction book.

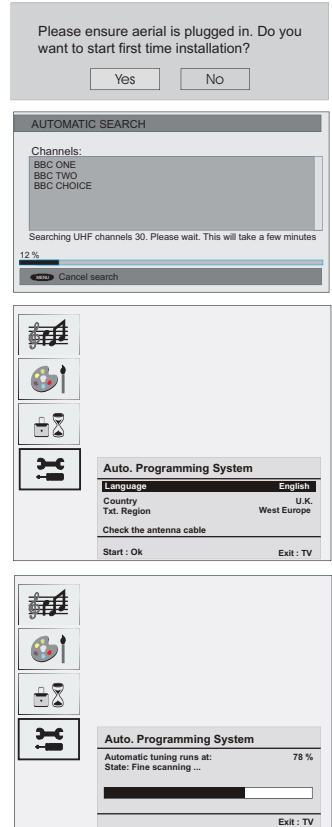

important note.

Once the TV has found all your local stations, they are then automatically assigned a programme number and name, if available from the broadcast.

HITACHI

Inspire the Next

Hitachi Consumer Electronics Co. Ltd.,
Shin-Otemachi Bldg 5f, 2-1, Otemachi 2-Chome,
Chiyoda-Ku, Tokyo 100-0004 Japan

HITACHI EUROPE LTD.

Consumer Affairs Department
PO Box 3007
Maidenhead
Berkshire SL6 8ZE

UNITED KINGDOM

Tel: 0844 481 0297
Email: consumer.mail@hitachi-eu.com

HITACHI EUROPE S.A.

364, Kifissias Ave. & 1, Delfon Str.
152 33 Chalandri
Athens

GREECE

Tel: 210 6837200
Fax: 210 6835694
Email: dmgservice.gr@hitachi-eu.com

HITACHI EUROPE GmbH

Am Seestern 18
40547 Düsseldorf

GERMANY

Tel: 211-5283-808
Fax: 211-5283-809
Hotline: 0180 - 551 25 51 (12ct/min.)
Email: Service.germany@hitachi-eu.com

HITACHI EUROPE S.A.

Gran Via Carles III, 86 Planta 5^a
Edificios Trade - Torre Este
08028 Barcelona

SPAIN

Tel: 0034 934 092 5 50
Email: garantias@ltr-hitachi.es

HITACHI EUROPE S.r.l.

Via T. Gulli, 39
20147 MILANO

ITALY

Tel. +39 02 2570094
Fax +39 02 25712029
E.mail: aerta_sas@iol.it

HITACHI EUROPE AB

Frösundaviks Alle 15
169 29 Solna

SWEDEN

Sweden Tel: +46 856 27 1100
Finland Tel: +358 10 8503 085
Norway Tel: +47 9847 3898
Denmark Tel: +45 43 43 6050
Email: rma.nordic@hitachi-eu.com

HITACHI EUROPE S.A.S

Digital Media Group
77 Rue Alexandre Dumas
69120 Vaulx en Velin

FRANCE

Tel: 04 37 42 84 30
Email: france.consommateur@hitachi-eu.com

www.hitachidigitalmedia.com