

HITACHI

User Guide

C28W510SN

C28W510TN

C32W510SN

C24W511TN

C24W511SN

C28W511TN

C32W511TN

C28WD2TN2

C32WD2TN2



Dear Hitachi Customer,

Congratulations on your purchase of the very latest 'state of the art' television from HITACHI. At Hitachi we pride ourselves on producing high quality televisions with outstanding picture and audio capabilities, coupled with Hitachi's reputation for superior reliability.

You should enjoy many years of trouble free operation from your TV. Take some time to read the Operating Guide thoroughly, and if you encounter any difficulty, firstly refer to the Trouble Shooting guide at the rear of this manual. If, in the unlikely event of a problem occurring on your TV, contact your dealer immediately. Please read the Guarantee carefully.

*Dolby Pro Logic Surround Sound is the domestic version of Cinema Dolby stereo sound, and allows the viewer to enjoy full cinematic sound quality when watching films or events recorded in Dolby Surround. The surround channels reinforce the stereo image, allowing front to rear sound movements (such as overhead aircraft effects) which immerses the viewer in ambience and special effects. In addition to this, the Pro Logic circuitry is able to create a centre channel, this anchors dialogue and central sounds to the screen so that speech does not become disembodied or lost in sound effects.

Dolby Pro Logic together with Hitachi's unique 3DS Spatial Sound system will allow you to enjoy full Cinema Sound in your own home. In addition to this your Hitachi TV has full expansion sockets to accommodate optional speaker systems, so you can set up your listening area to match your most exacting audio demands and aesthetic preferences. These features along with outstanding picture quality and of course our reputation for superior reliability will continually reward your decision for choosing HITACHI.

*Manufactured under license from Dolby Laboratories Licensing Corporation. DOLBY, the double-D Symbol  and "PRO LOGIC" are the trademarks of Dolby Laboratories Licensing Corporation.

CONTENTS

Introduction & Contents	2
TV Safety	3
Battery Installation & Safety	4
TV Installation	5
General TV Controls Overview	6
Automatic Tuning Procedure	7
Manual Tuning Procedure	9
Picture & Audio Controls	12
HITACHI 3DS System	14
Speaker Configuration Menu	15
Sound Mode	16
Surround Setup Menu	17
Connecting External Audio Equipment	18
Feature Menu	19
Widescreen Modes	20
Connecting External AV equipment	22
Teletext & VCR Operation	24
Handset Layout	25
Handset Functions	26
Trouble Shooting Guide	27
Your Guarantee	28
Technical Specifications	29
Environmental Notice from HITACHI	30



This television has been designed and manufactured to meet international safety standards, but like any electrical equipment, care must be taken if you are to obtain the best results and safety is to be assured.





DO read the operating instructions before you attempt to use the equipment.



DO ensure that all connections, (including the mains plug, extension leads and inter-connections between the pieces of equipment), are properly made and in accordance with the manufacturers instructions. Switch off and withdraw the mains plug before making or changing connections.



DO observe the manufacturers instructions when connecting extension leads to your TV. The fuse should be a 5 Amp fuse with the safety symbols  and  displayed. If you are in any doubt about the extension installation, please consult a competent electrician.



Should you require to replace the fuse in the moulded mains plug with a new fuse then please replace with one of the same value, type and approval as the original. Ensure the fuse cover is returned to its original position.



DO consult your dealer if you are in any doubt about installation, operation or safety of your equipment.



DO be careful with any glass panels or doors on equipment.



DO place your TV on a flat surface, or if supplied, the stand accessory.



DO NOT remove any fixed cover as this may expose dangerous voltages.



DO NOT cut off the fitted mains plug as it may contain a special radio interference filter, the removal of which could lead to impaired performance. If you wish to extend the lead, obtain an appropriate extension lead or consult your dealer.



DO NOT continue to operate the equipment if you are in any doubt about it working normally or if it is damaged in any way - switch off, withdraw the mains plug and consult your dealer.



IF you intend placing this TV into a cabinet or a wall alcove, please ensure there is at least a 100mm (10cm) gap to the sides, rear and top of the TV. This is to allow for adequate ventilation during your TV's operation.



DO NOT leave equipment switched on when it is unattended unless it is specifically stated that it is designed for unattended operation or has a stand-by mode. Switch off using the switch on the equipment and show your family how to do this. Make special arrangements for infirm or handicapped people.



DO NOT obstruct the ventilation of the equipment, for example with curtains or soft furnishings. Overheating will cause damage and shorten the lifespan of your equipment.



DO NOT use makeshift stands and **NEVER** fix legs with wood screws - to ensure complete safety, always fit the manufacturers approved stand or legs with the fixings provided according to the instructions.



DO NOT allow electrical equipment to be exposed to rain or moisture.



DO NOT place hot objects such as candles or nightlights on, or close to, equipment. High temperatures can melt plastic and lead to fires.



DO NOT listen to headphones at high volume, as such use can permanently damage your hearing.



NEVER let anyone, especially children, push anything into holes, slots, or any other opening in the case - this could result in a fatal electrical shock.



NEVER guess or take chances with electrical equipment of any kind - it is better to be safe than sorry!



DO NOT use equipment such as personal stereos or radios so that you are distracted from the requirements of traffic safety. It is illegal to watch television whilst driving.

Battery Installation

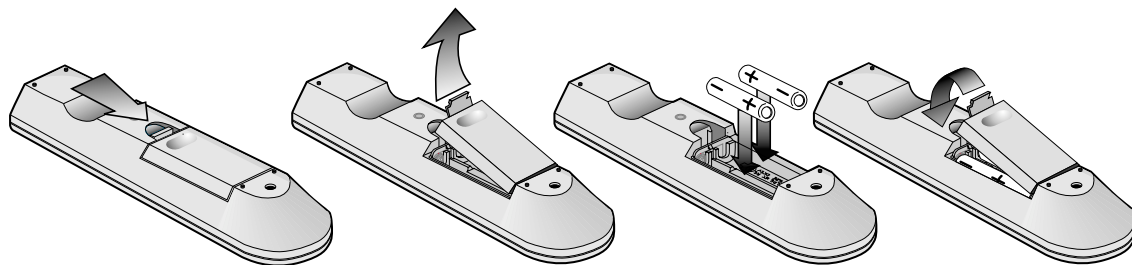

1 Remove cover of handset by lifting up the cover at the recess.

2 Insert batteries into handset as shown and replace cover.



1. When inserting the batteries make sure the polarities are correct, that is, '+' to '+', '-' to '-'.
2. Replace the batteries with the equivalent 'AA' type.
3. Discard old batteries safely, following the battery safety guidelines.

Battery Safety Guidelines

Used correctly, batteries are a safe and dependable source of portable power. However, problems can occur if they are misused or abused - resulting in leakage, or in extreme cases, fire or explosion. Here are some simple guidelines to safe battery use designed to eliminate any such problems.

always

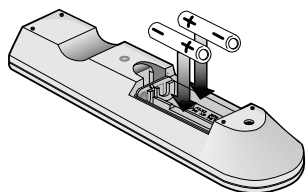

Take care to fit your batteries correctly, observing the plus '+' and minus '-' marks on the battery and appliance. Incorrect fitting can cause leakage, or in extreme cases, fire or explosion.

always

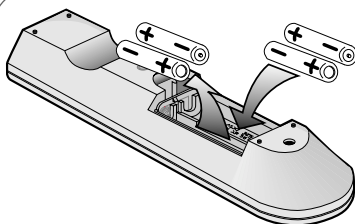

Replace the whole set of batteries at one time, taking care not to mix old and new batteries of different types, since this can result in leakage, or in extreme cases, fire or explosion.

always

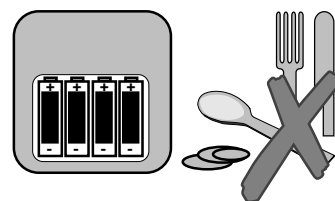

Store unused batteries in their packaging and away from metal objects which may cause a short circuit resulting in leakage, or in extreme cases, fire or explosion.

always

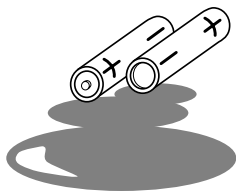

Remove dead batteries from equipment, and all batteries from equipment that is to be left for long periods of time without any use. Otherwise the batteries may leak and cause damage.

never!

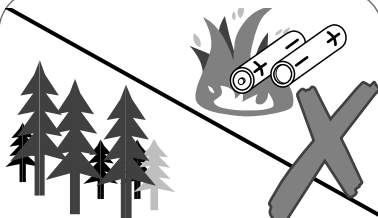

Never dispose of batteries in fire as this can cause an explosion. Respect the environment - always dispose of batteries in an environmentally friendly manner.

never!

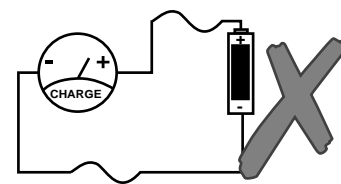

Never attempt to recharge ordinary batteries, either in a charger or by applying heat to them. They may leak, cause fire or even explode. Rechargeable NiCAD batteries and chargers can be purchased from any good High Street electrical retailer.

Before installing your TV please read the following important notes:

If you intend placing this TV into a cabinet or a wall alcove, please ensure there is at least a 100mm (10cm) gap to the sides, rear and top of the Television. This is to allow for adequate ventilation during TV operation.

Don't allow soft furnishings such as curtains to be draped over the TV whilst in operation.

Never place the TV on to a carpet during normal operation - this could obstruct ventilation slots on the base of the TV. Always place the TV on a flat surface, or if supplied, the stand accessory.

Failure to observe the above guidelines could result in serious overheating of your TV, or in extreme cases, even fire.

Connecting your TV to the mains socket.
(Please read the Safety Notes in the 'TV Safety Section' with reference to unattended operation).

Insert Plug and
Switch on

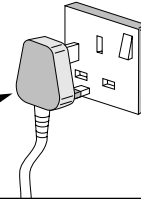

TV only installation.

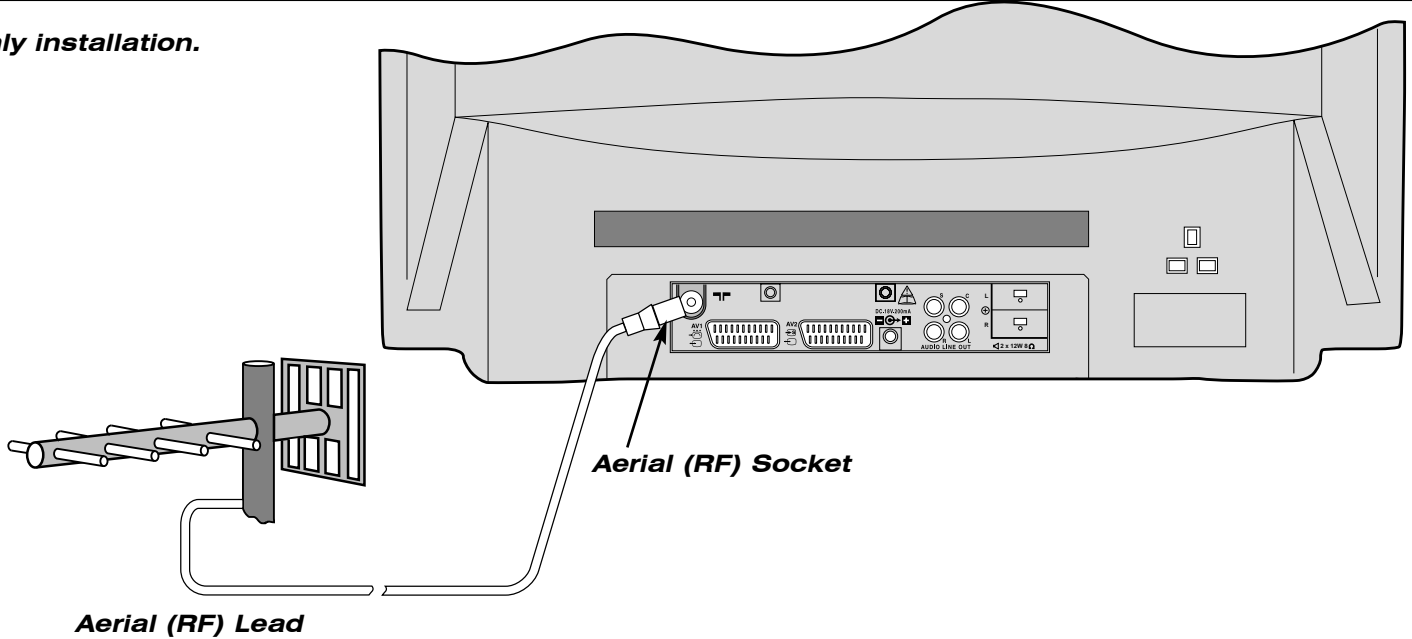

Installation via a VCR.

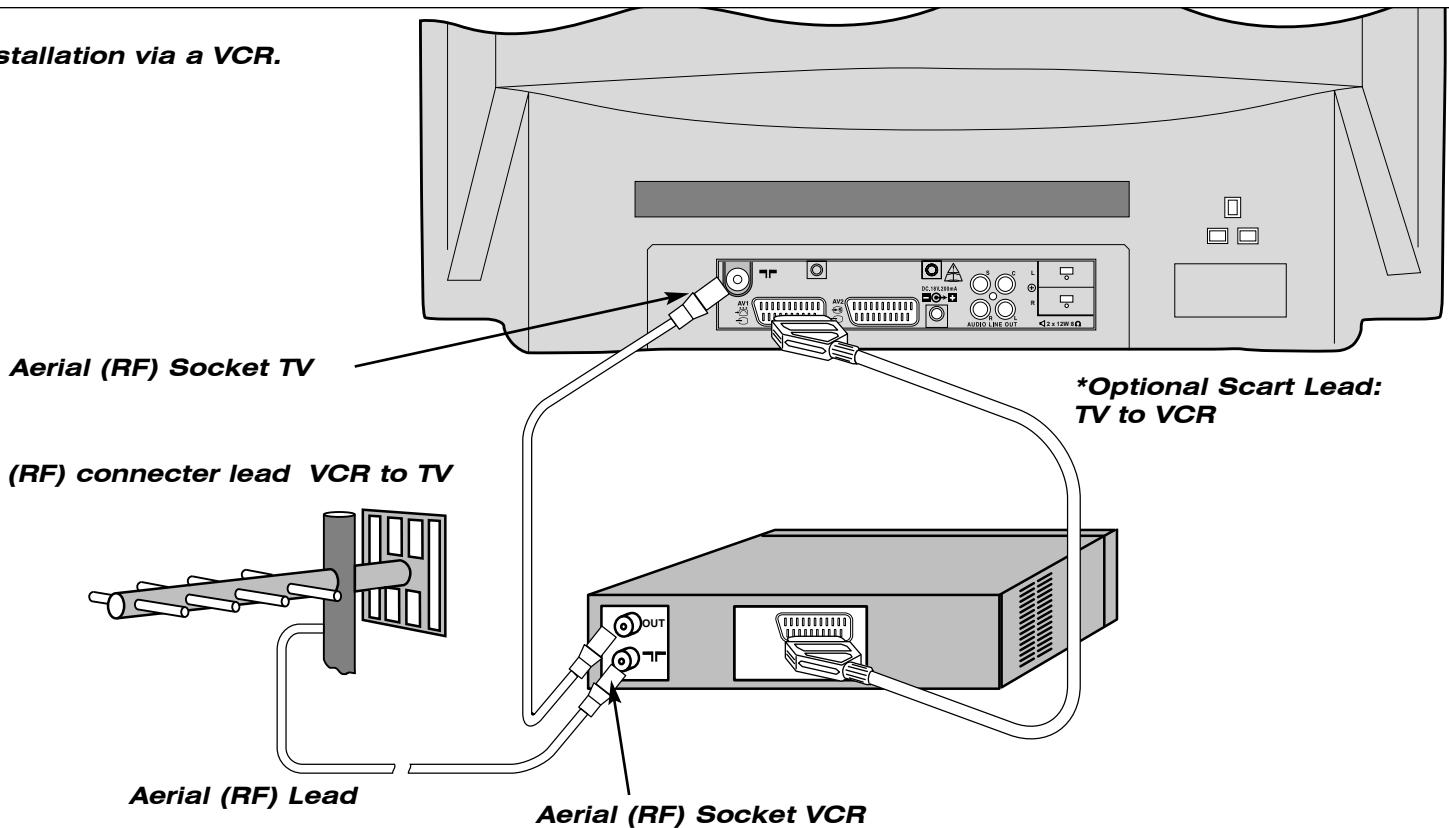

*A scart lead should be fitted between your TV and VCR to enhance your picture and sound quality. Scart leads are essential if you have a stereo TV and VCR and wish to obtain stereo sound from your equipment. These leads can be purchased from your Hitachi dealer or any good 'High Street' electrical retailer.

PLEASE NOTE: The model illustrated throughout this User Guide is the C28W511TN. Other models may differ.

FRONT CONTROL PANEL

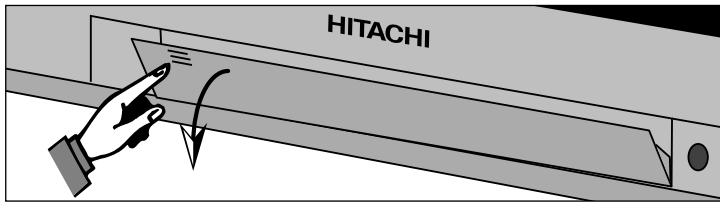

Access to the front control panel is gained by pushing the door in and releasing. The front control panel contains items such as the Headphone socket, Audio/Video sockets, Programme +/- and Volume +/- buttons. Also located on the front are the ON/OFF button, Infra Red Lens and TV Mode Light.

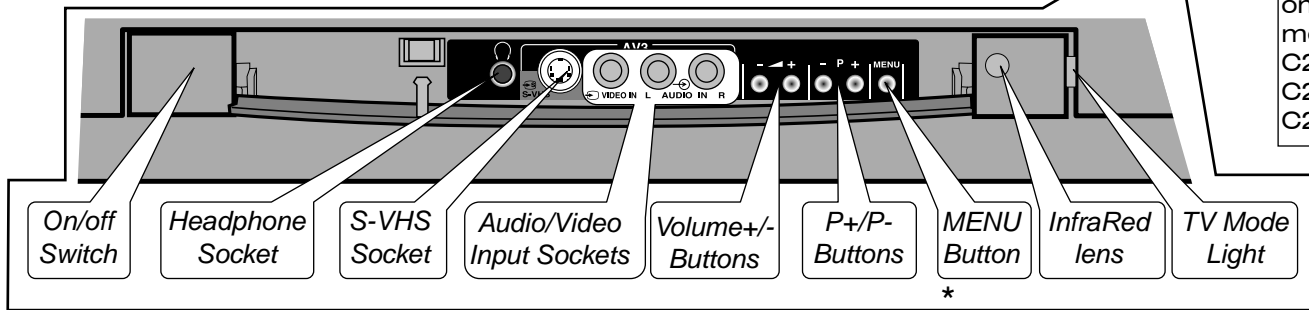

* This button is only available on models
C28W510TN
C28W511TN
C28W510SN

*



***IMPORTANT NOTE** The 18 Volt Output socket is used for connection of HITACHI auxiliary equipment only and under no circumstances should be connected to other external equipment. Failure to observe this may result in serious damage to your equipment.

REAR CONNECTING SOCKETS

The rear of your TV contains an aerial RF input and two scart sockets, AV1 and AV2. The RF/ aerial socket is permanently connected to an RF source i.e. an aerial antenna shown in 'TV Installation section'. The scart sockets are used to connect external equipment such as VCR's, Satellite Receivers / Decoder etc. Connection of this equipment is explained in greater detail in the 'Connecting of External AV Equipment section' of this manual. Also located on the rear of the TV are the Audio Sockets and the *18 Volt Output socket.

Consult your HITACHI dealer with regards to purchasing HITACHI auxiliary equipment.

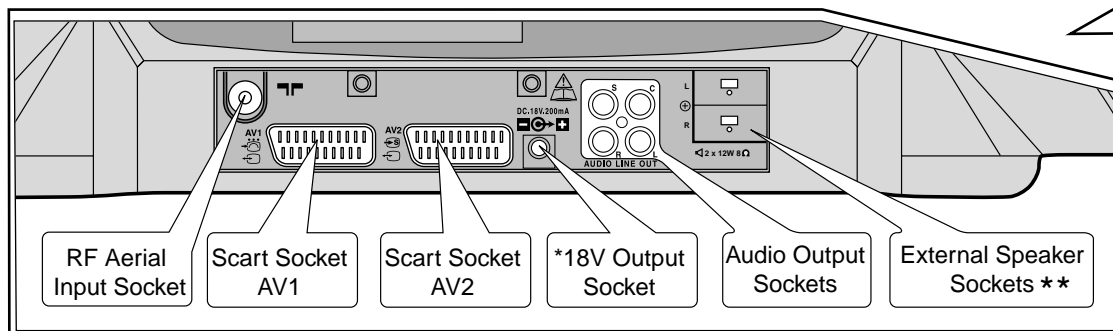
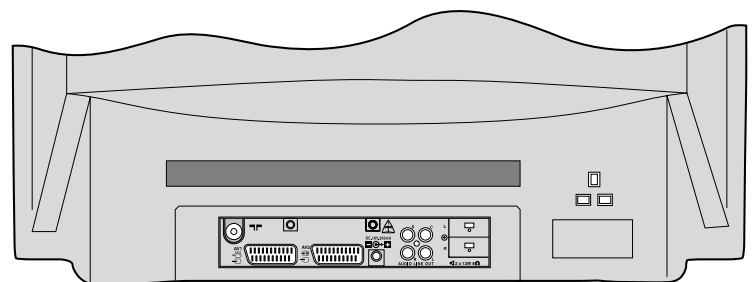

** Din sockets are not available on models
C28W510TN
C28W511TN
C28W510SN

SWITCHING ON

To switch your TV on, press the ON/OFF button shown above. If the TV fails to display anything on the screen, but the red TV mode light appears bright, then the TV is in Stand by mode. Press the Stand by button on your handset to activate the TV. The red TV mode light will then dim and you should allow the TV a few seconds for a picture to appear.

SIGNAL QUALITY - If poor or noisy signals are experienced from your TV during normal operation, fit the supplied Relay RF cable between your VCR and TV. This measure will improve the picture quality on your TV.

To automatically tune this TV to your local broadcasting stations follow the step by step guide below. Once the TV has found all your local stations, then they are automatically assigned into the following order:

1. BBC1; 2: BBC2; 3: ITV; 4: CH4/S4C; 5: CH5 (subject to availability); 6: Satellite.

Alternatively, if you are familiar with local broadcasting frequency or CH numbers, then these can be entered manually. Please refer to the Manual Tuning Procedure section of this booklet.

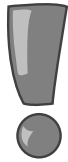

IMPORTANT NOTE: If you have a VCR or a Satellite receiver connected to this TV please ensure that they are switched on before Autotune commences. In the case of a VCR, insert a pre-recorded tape and begin playback of your equipment. With a Satellite receiver, select SKY NEWS. These measures ensure that all your equipment is tuned in during the AUTOTUNE procedure. (Satellite equipment installation is explained in the 'Connecting of External AV Equipment section').

Note: The VCR programme number should always be set to 0

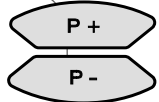
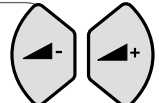
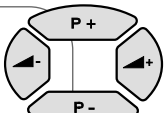
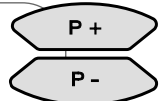
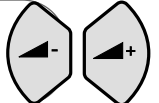
- 1 Press and **HOLD** the MENU button until Main Menu with INSTALL is shown 
- 2 Highlight INSTALL using the up/down buttons (if INSTALL is not shown follow step above once more). 
- 3 Press the left/right buttons select INSTALL. The INSTALL menu is shown. 
- 4 If language setting is incorrect, use up/down buttons to highlight LANGUAGE, and select using the left/right buttons. 
- 5 Use the up/down buttons to highlight AUTOTUNE. 
- 6 Use the left/right buttons to begin AUTOTUNE. 

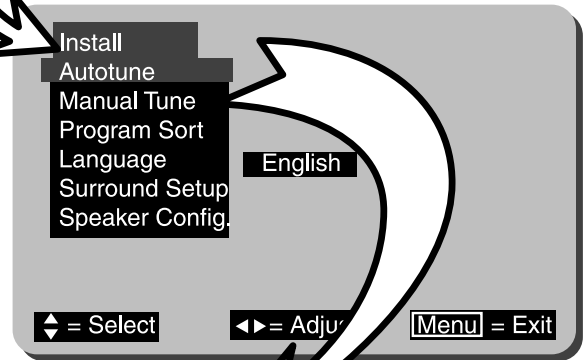
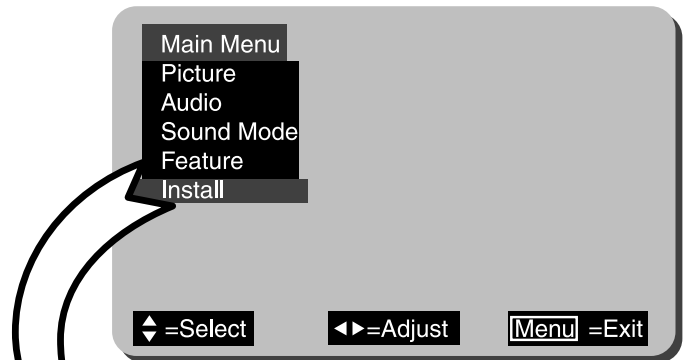





Completed Autotune example.

Automatic Tuning cont.

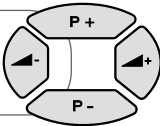
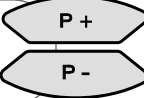
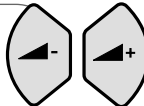
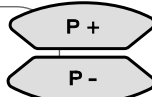
Program Sort

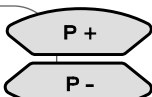
The PROGRAM SORT menu allows the user to swap programme numbers from one location to another. If necessary follow the steps below.

- 1 Press and **HOLD** the MENU button until Main Menu with INSTALL is shown 
- 2 Use up/down buttons to **highlight** INSTALL and use the left/right buttons to **select**. 
- 3 Use the up/down buttons to **highlight** PROGRAM SORT. 
- 4 Use left/right buttons to **select** PROGRAM SORT. 
- 5 The PROGRAM SORT menu is displayed.
- 6 Use the up/down buttons to **highlight** Program to change (example shows Program 3 ITV) 
- 7 Press the 'CH' button to **select** (selection bar turns RED in colour) 
- 8 Use the up/down buttons to **highlight** Program to be replaced (example shows Program 1 BBC1) 
- 9 Once highlighted press CH key once more to confirm selection (selection bar returns to BLUE) 
- 10 Repeat above to swap other programs, or repeatedly press MENU button to return to TV operation. 

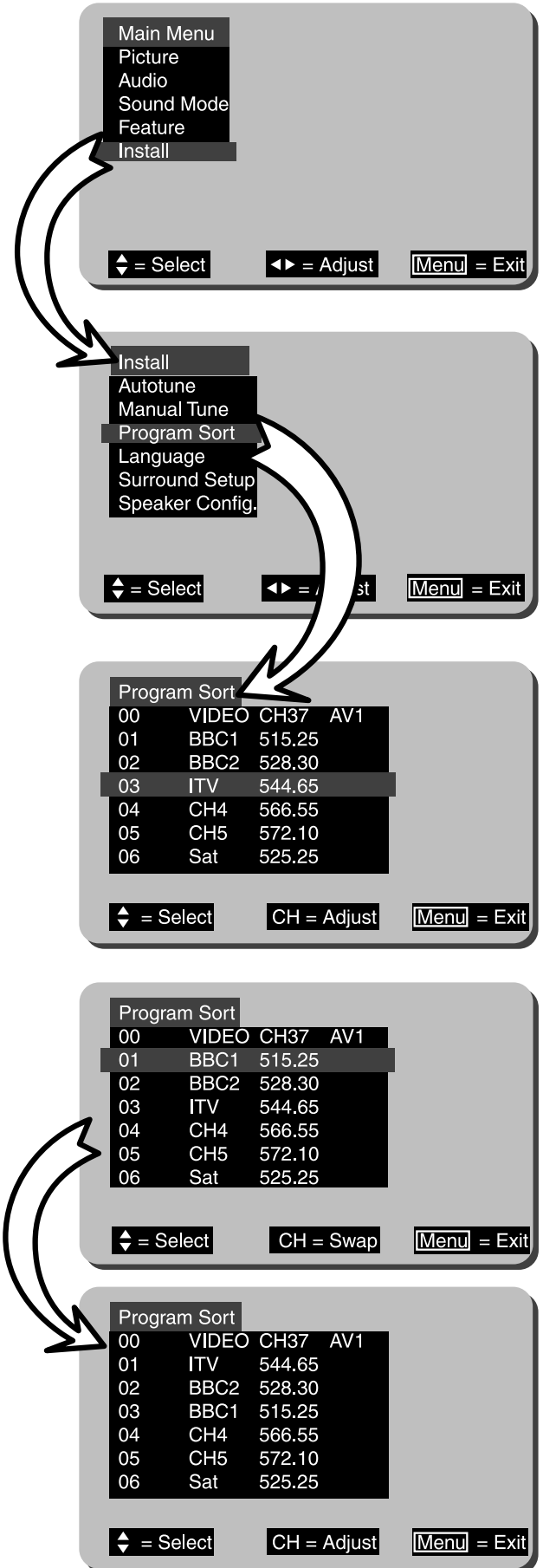

In this example BBC1 on Program 1 has been selected so that it may be swapped with Program 3 (ITV).

If desired, you may manually tune this TV. There are several methods of Manual Tuning, these include Search Tuning / Fine Tuning and Frequency or CH manual input (this requires you to know your local broadcasting frequency or CH number). This section will also deal with items such as assigning AV sockets to program numbers and Program Naming.

Search Tuning / Fine Tuning

This section deals with locating broadcasting stations using the Search Tuning and combined Fine Tuning facility. Fine Tuning may be required after Search or Automatic Tuning is complete.

1 Press and **HOLD** the MENU button until Main Menu with INSTALL is shown



2 Use up/down buttons to **highlight** INSTALL and use the left/right buttons to **select**.

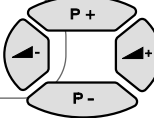

3 Use the up/down buttons to **highlight** MANUAL TUNE.

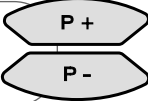

4 The MANUAL TUNE menu is displayed (bottom right).

5 Use the up/down/left/right buttons to **highlight** frequency bar of programme N° to Search Tune.

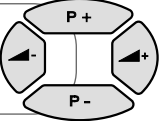

6 Press 'CH' button to **select** (bar turns RED)



7 Press the left/right buttons to begin SEARCH TUNE.



8 When a broadcast is found either repeatedly press the MENU button to store and exit to TV



OR

9 To continue SEARCH TUNE simply press the left/right buttons the TV will start searching once more..

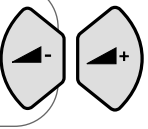

To FINE TUNE press the up/down buttons until the picture becomes clear.

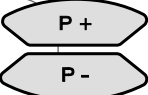



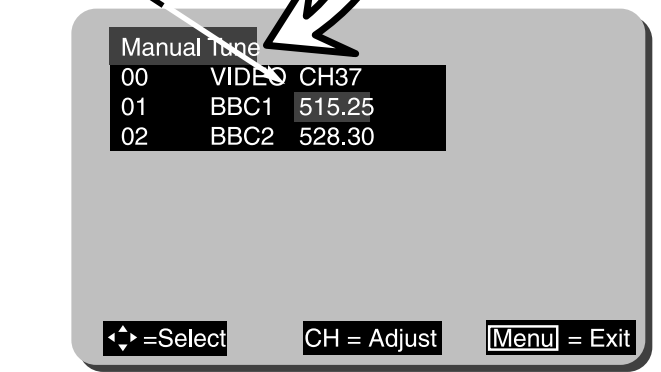
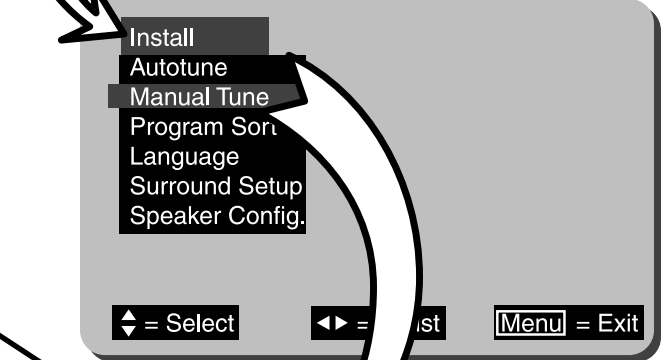
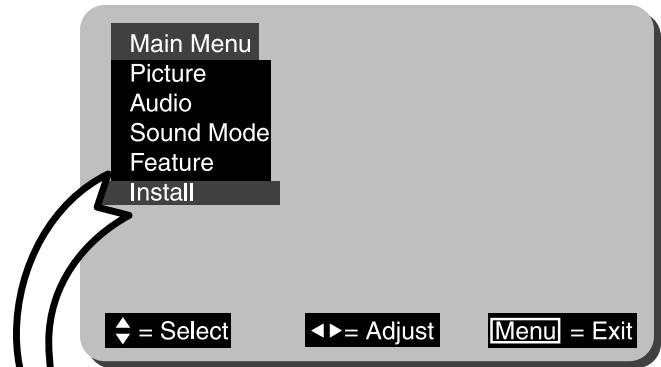





10 When complete repeatedly press the MENU button to exit, or repeat above to Search/Fine Tune other program numbers if necessary.





Manual Tuning cont.

Entering Known Frequencies



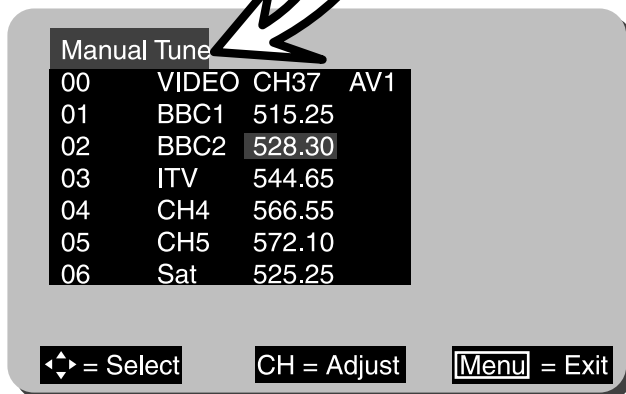
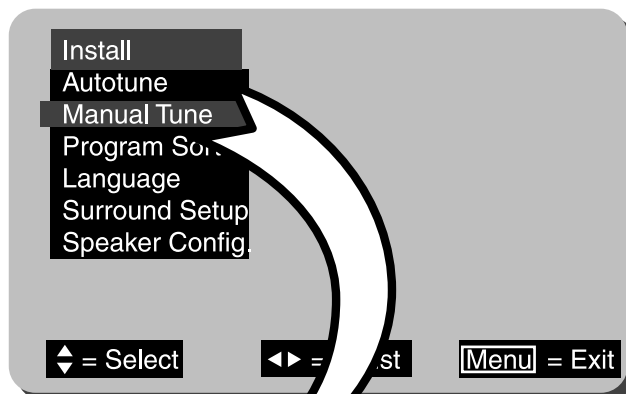





Broadcasting stations transmit the signal to your TV on a particular defined frequency i.e. 525.25MHz. These frequencies can be entered manually if known, and you can obtain this information by calling your local operator. In addition to frequency transmission a corresponding CHANNEL N° is also used e.g. CH34, and this too can be directly input to your TV if known. (The S-- number has no function on this TV).

- 1 Press and **HOLD** the MENU button  until Main Menu with INSTALL is shown. Use up/down buttons  to highlight INSTALL - select by pressing the left/right buttons. 
- 2 Use up/down buttons  to **highlight** MANUAL TUNE, **select** by using the left/right buttons. 
- 3 Use the left/right/up/down buttons to highlight the frequency of the program number you wish to enter. 
- 4 Press the 'CH' button on your hand-set once - the column changes RED to indicate selection. 
- 5 Repeatedly press CH key to select CH- - or ---.--, and enter the known number using 0-9 keys. 
- 6 Once the number has been entered, press the MENU key once more and the display turns BLUE. This is now stored. Press MENU to exit. 



Assigning AV Prog. N°s

When AV sockets are commonly used, for example, if you view camcorder recorded events frequently, then we suggest assigning a dedicated program number on your TV. This can be any program number that has not already been assigned. Follow the step by step guide below.



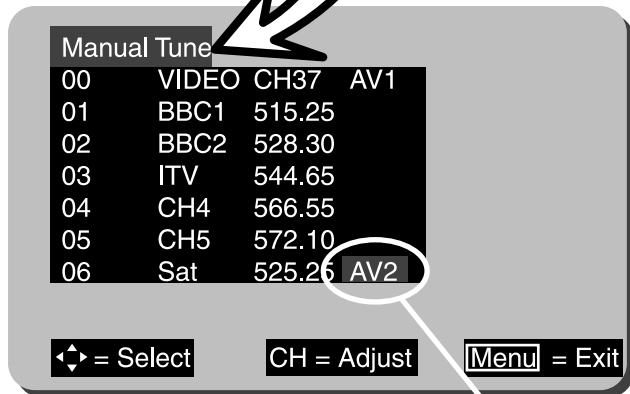
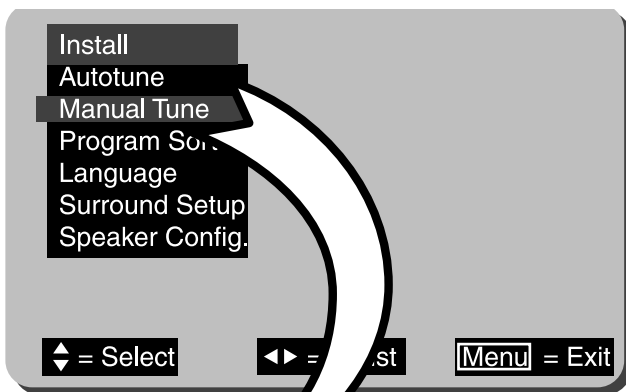







- 1 Press and **HOLD** the MENU button  until Main Menu with INSTALL is shown. Use up/down buttons  to highlight INSTALL - select by pressing the left/right buttons. 
- 2 Use up/down buttons  to **highlight** MANUAL TUNE, **select** by using the left/right buttons. 
- 3 Use the left/right/up/down buttons to highlight the AV column of the program number you wish to use. 
- 4 Once highlighted press the 'CH' button to allow changes to be entered. 
- 5 Select between each AV mode using the left/right buttons 
- 6 Repeat above to enter other AV sockets or repeatedly press MENU button to store and exit to TV mode. 

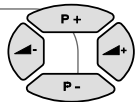

AV2 assigned to Program 6

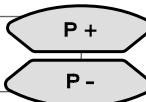
Program Naming

After Tuning in, most broadcasting station names appear on screen i.e. BBC1, BBC2, ITV etc.. However, you may change or add program names whenever you desire. To add or change program names follow the simple step by step guide below.



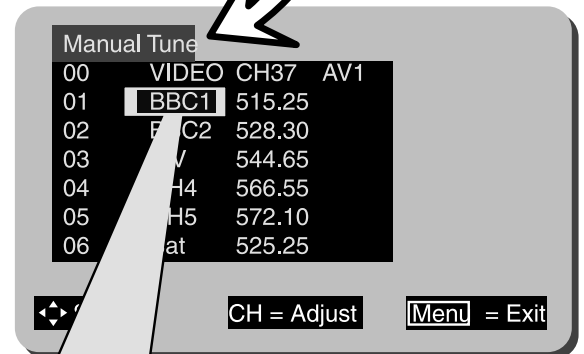
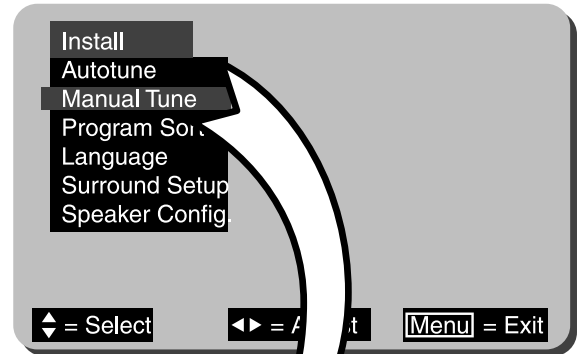

- 1 Press and **HOLD** the MENU button  until Main Menu with INSTALL is shown. Use up/down buttons  to highlight INSTALL - select by pressing the left/right buttons. 
- 2 Use up/down buttons  to **highlight** MANUAL TUNE, **select** by using the left/right buttons. 
- 3 Use the left/right/up/down buttons to highlight the program name you wish to change. 
- 4 Press the 'CH' button to select program name you wish to change (the first digit will blink). 
- 5 Use the up/down cursor keys to scroll through the characters. 
- 6 Once the first character has been entered select next digit using the right button and repeat above step. 
- 7 You may use up to 5 characters for any one Programme Name. Press MENU button to store. 
- 8 Repeat above steps to assign other Program Names or repeatedly press MENU button to exit to TV mode. 

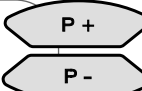
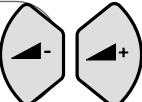
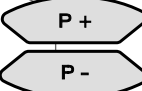
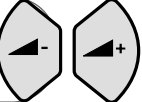

When selected the character will blink on and off.

Picture and Audio Controls

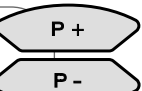
Picture settings are controlled via the TV's on board Menu system. These levels have already been preset at the factory and should require no adjustment. However, your personal viewing preferences may vary from these settings and alteration should be performed as follows:-

- 1 Press the MENU button on your handset until the MAIN MENU appears. 
- 2 Use the up/down buttons to **highlight** PICTURE. 
- 3 Use the left/right buttons to **select** the PICTURE option. 
- 4 Highlight the control to be adjusted using the up/down buttons. 
- 5 Use the left/right buttons adjust your selection. 
- 6 Select and adjust controls as necessary, once complete press MENU button repeatedly to exit 
- 7 To obtain the MORE sub menu highlight MORE using the up/down cursor keys. 
- 8 Select and adjust controls as necessary, once complete press menu button to exit. 

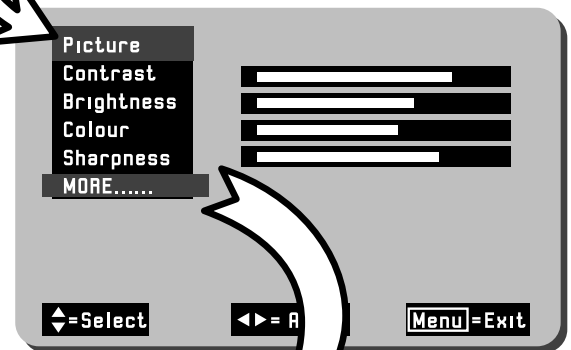
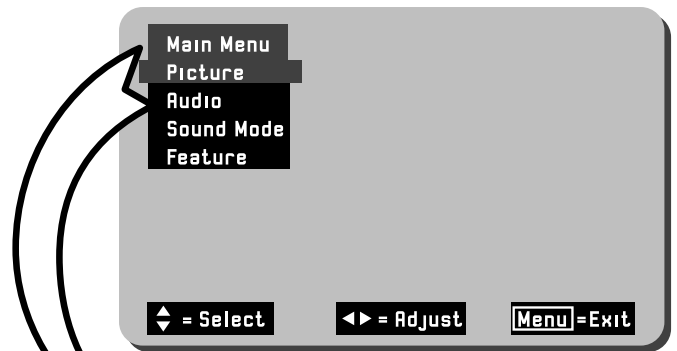

Picture Menu

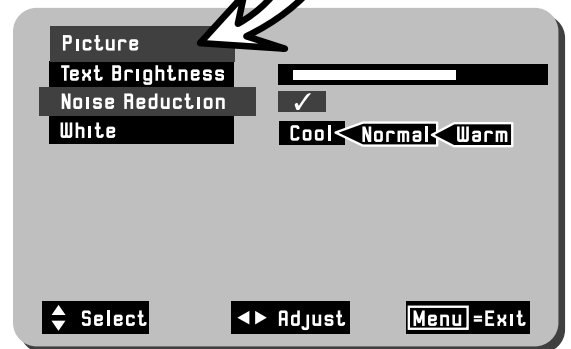

Picture Sub Menu

Function Controls

CONTRAST:

BRIGHTNESS:

COLOUR:

SHARPNESS:



***HUE:**

*(Hue control appears on-screen only if an NTSC signal is received via the AV sockets).



More Functions

TEXT BRIGHTNESS : This function allows the user to adjust the text brightness of On Screen Display windows and Teletext pages.

NOISE REDUCTION :Noise Reduction improves picture quality when a signal becomes weak or when viewing poorly recorded VCR tapes. When selected a ✓ is displayed.

WHITE: This feature controls the colour temperature displayed on the picture tube.

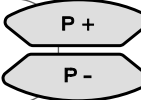
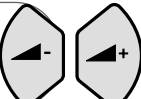
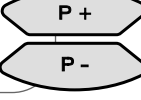
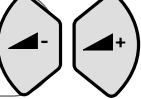
The Sound Menu is accessed via the TV's on-board MENU system, and allows the user to control such features as Volume, Bass, Treble, Balance and Bass Boost. These settings have already been preset at the factory, however, your personal listening tastes may differ from those set. Please follow the guide below for adjustment and setting.

- 1 Press the MENU button on your handset until the MAIN MENU appears. 
- 2 Use the up/down buttons to **highlight** AUDIO. 
- 3 Use the left/right buttons to **select** the AUDIO option. 
- 4 Highlight the control to be adjusted using the up/down buttons. 
- 5 Use the left/right buttons adjust your selection. 
- 6 Select and adjust controls as necessary, once complete press MENU button repeatedly to exit 

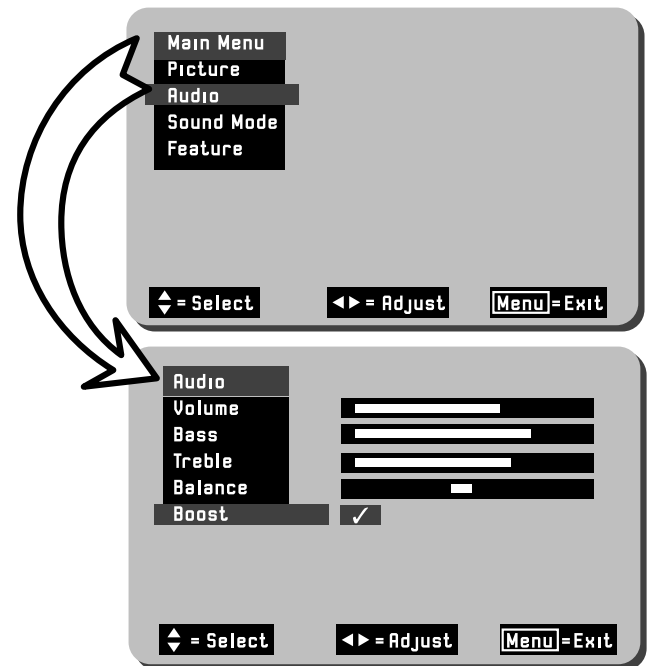

Function Controls

VOLUME:

BASS:

TREBLE:



Minimum setting



Maximum setting

BALANCE:



Left Speaker



Right & Left Speakers



Right Speaker



NOTE: The balance control is disabled whilst in Dolby® Pro Logic and Dolby® Pro Logic Theatre modes

BASS BOOST: When selected a ✓ is displayed.

INTERNAL SPEAKER OPTION

Through innovative design and complex internal circuitry, HITACHI have produced this television which recreates superb Dolby Pro Logic cinematic sound. However, to enhance your viewing pleasure when using only the TV's own internal speakers, we have created the 3DS system (3 Dimensional Spatial sound). The 3DS system gives a much wider spread of sound from the TV giving the impression of sound coming from the sides of the room rather than the in built speakers, whilst the important centre dialogue channel is unaltered, still appearing to come from the centre of the screen.



Activating the 3DS sound spatializer is simple, press the button marked  on the handset to activate, one press more will de-activate. When activated a '' symbol appears in the top right hand corner of the screen indicating that 3DS is on. When de-activated the  symbol is displayed on-screen (see below).

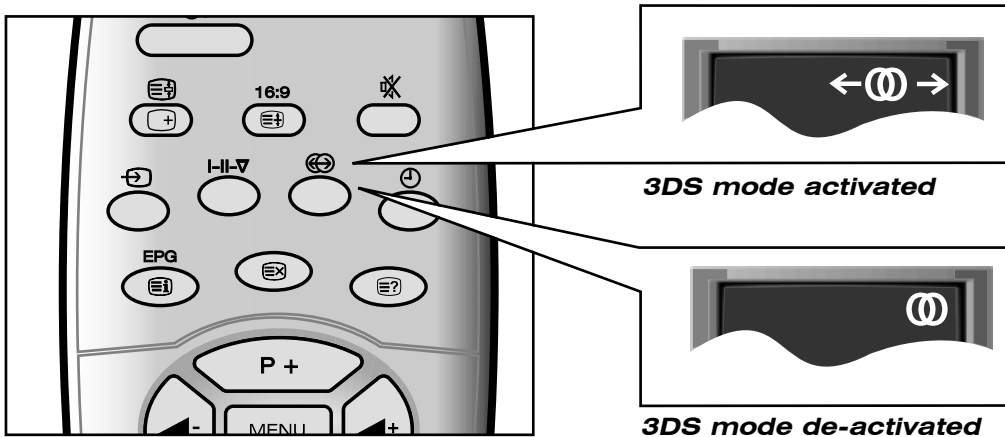

NOTE: In order to appreciate the effect of 3DS it is essential that you are listening to at least a stereophonic program with active left or right information. For example, certain programs containing only speech will appear to have no effect when 3DS mode is selected.

EXTERNAL SPEAKER OPTION

Place the external speakers around the television in a position which best suits your environment. Connect the left sided speaker connection to the socket marked 'L' at the rear of your television, and connect the right sided speaker to the socket marked 'R' at the rear of your television (see illustration).

Please Note

Once speakers are connected, you will lose sound from your TV's internal speakers. For more details on sound see 'Speaker Configuration Menu section.'

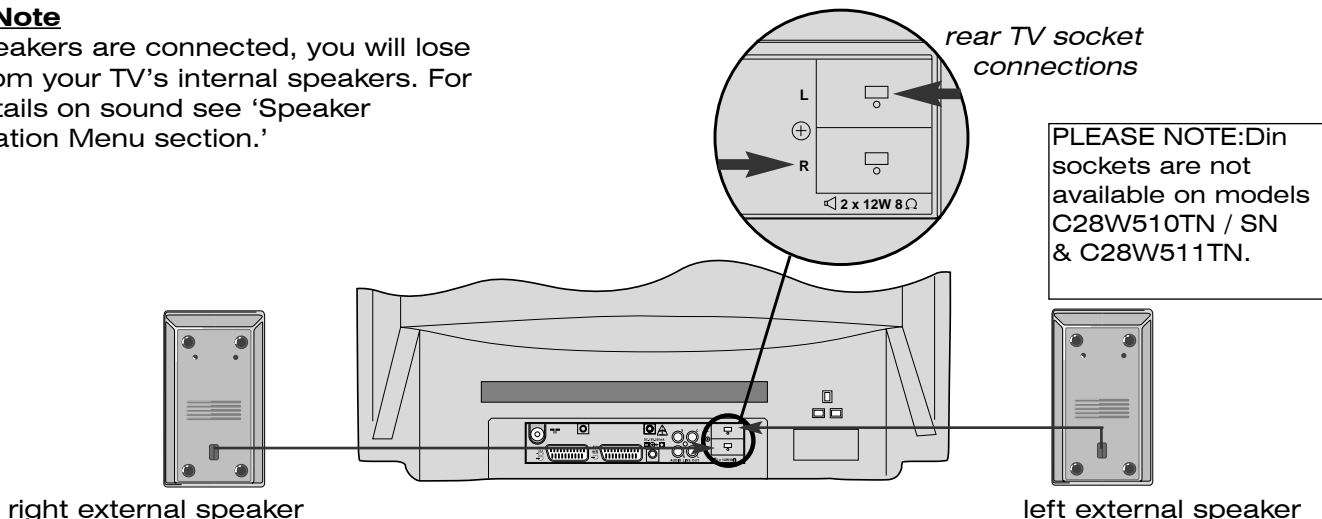

Speaker Configuration Menu

The Speaker Configuration menu allows the user to access various centre speaker modes. This is particularly useful if an external amplifier is connected to the Centre PHONO Socket. In addition to these options, you may want to replace the TV's internal speaker sound to a full external amplified speaker setup. In this case the user can mute the TV's speakers from within the Speaker Configuration Menu, allowing sound only to be heard through the external amplified sound sources. Follow the step by step guide below:
Follow the guide below describing options with and without external amplifiers connected:

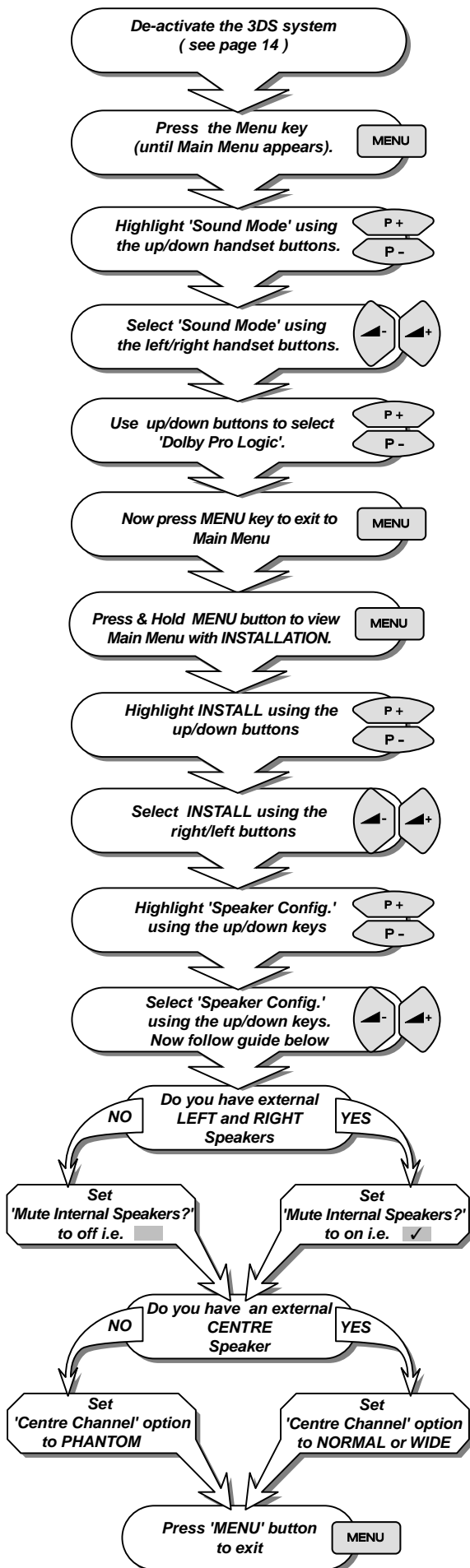

Option 1: (PHANTOM) If you do not have any external amplifiers connected to the TV then select the PHANTOM mode permanently. Phantom allows the TV to create centre dialogue information using the TV's left and right internal speakers. (NORMAL and WIDE have no effect when there are no external centre amplifiers connected [See Notes below]).

Option 2: (PHANTOM) If there are external surround amplifiers connected but no centre amplifier connected, then select PHANTOM mode. This again allows the TV to create centre dialogue information using the left and right internal speakers. (NORMAL and WIDE have no effect when there are no external centre amplifiers connected [See Notes below]).

Option 3: (NORMAL) In option 3, it is presumed the user has a limited bass response centre amplifier connected. If you feel that this best describes your setup then select NORMAL. This mode will anchor dialogue to your centre amplifier whilst relaying bass response through the TV's internal left and right speakers [See Note below].

Option 4: (WIDE) This option assumes there is a good bass response centre amplifier connected to your TV. If this option describes your setup then select WIDE from the Speaker Configuration Menu. In this mode all bass response and dialogue is fed to the centre amplifier [See Notes below].







Speaker Configuration Menu - note the displayed information window, this briefly describes the mode you have selected.

PLEASE NOTE:
In 2 speaker mode i.e. using only internal TV speakers with 3DS activated, the CENTRE channel option will display PHANTOM and cannot be changed to any other mode. Whilst in HALL or STEREO modes the 'Centre Channel' option displays 'OFF', and also cannot be changed to any other mode.

Sound Mode Menu

The Sound Mode selection menu allows the user to select between various sound effects. These effects enhance your viewing pleasure, particularly when viewing movies, sports events and concerts etc.. The guide below provides a description of the Sound Modes and what mode is suggested for viewing particular programs.

- 1 Press the MENU button on your handset until the MAIN MENU appears. 
- 2 Press the YELLOW colour coded button to view SOUND MODE menu.
- 3 Select desired sound mode by using the up/down buttons. 

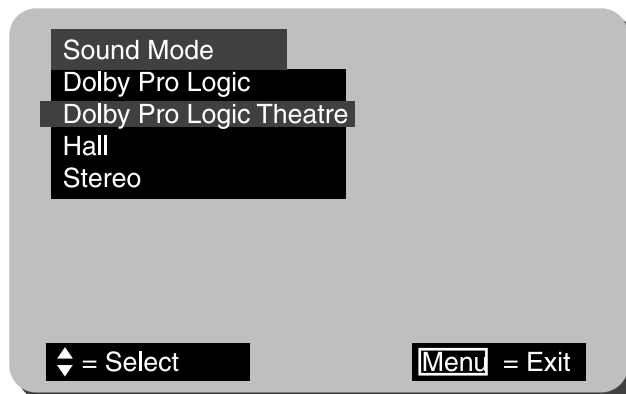
- 4 After selecting the desired sound mode, exit to TV mode by repeatedly pressing the MENU key. 



DOLBY PRO LOGIC (Internal Speaker Mode)

In this mode virtual surround sound can be created using just the TV's internal speakers. Activate 3DS to enable virtual surround sound. This mode is also particularly suitable for films and programmes that display the DOLBY SURROUND caption. (This mode is recommended for the majority of TV viewing).

DOLBY PRO LOGIC (External Surround Amplifier Mode)

In this mode full cinematic sound is achieved using the TV's internal circuitry, combined with your choice of external surround sound amplifier and speakers. (Please Note: The 3DS system should be de-activated for this mode see 'HITACHI 3DS System Section'). This mode is particularly suited to action movies and dramas that display the DOLBY SURROUND caption.

DOLBY PRO LOGIC (Theatre)

This mode creates a larger sound field for those programmes that have little surround sound content. It is particularly effective when used in conjunction with external surround amplifiers, however, if you are using the TV internal speakers only, activating the 3DS system will also provide a pleasing aural sound.

HALL (External Surround Amplifier Mode)

HALL mode creates an ambient sound effect, especially when viewing mono broadcasts. Again this mode is very effective when used in conjunction with external surround amplifiers. Activate the 3DS mode whilst using the TV's internal speakers to obtain equally pleasing sound from your TV.

Select this mode when viewing classic films or drama events, which were recorded in mono.

STEREO

When STEREO mode is selected, the TV produces high quality stereo sound. Select this mode when viewing general TV programs and films. (3DS sound can be activated in this mode to provide a much wider stereo image).

NOTE:

1. Dolby Pro Logic can only be achieved by the addition of an external surround sound amplifier and speaker system. These are available from your HITACHI dealer.

2. Activating 3DS whilst using external surround amplifiers will cause the external surround channels to mute.

3. Activating and de-activating 3DS can only be achieved whilst no menus are on-screen (see 'HITACHI 3DS System Section').

Additional NICAM features

Stereo

This effect produces NICAM digital stereo sound from the TV. Use this mode for the majority of TV viewing. When selected the STEREO symbol is displayed in the top right hand corner of the TV screen as shown.

See also Hitachi 3DS System.



Monaural

In monaural mode the TV transmits a single sound source. The TV will automatically select this sound when a mono signal is found. Some stereo signals can become poor in adverse weather conditions, and mono should be selected to avoid poor sound. Use the  key to switch to mono (the symbol below appears when switched).









At Hitachi we appreciate the fact that not all living area's are the same, therefore the Surround Setup menu allows the user to balance the sound by adjusting the volume level to each channel, thus accommodating various room layouts.

In addition to this the menu also has a Surround Delay mode, this enables the viewer to select the optimum surround sound delay depending on your seating position relative to the TV (not available when 3DS is active).

*Please note that the Surround Set-up menu is only available in **Dolby® Pro Logic** and **Dolby® Pro Logic Theatre** modes, and thus will automatically default to **Dolby® Pro Logic** when selected.*

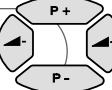
NOTE:When the SET-UP menu begins, the TV's sound is replaced with a noise signal. This is easier to balance than normal TV sound, and will cycle between the centre, left, right and surround channels (the centre channel cannot be adjusted unless an external amplifier for the centre channel is connected and is adjusted from PHANTOM to WIDE or NORMAL modes in the 'Speaker Config.' menu). If 3DS is active the surround PHONO output becomes muted.

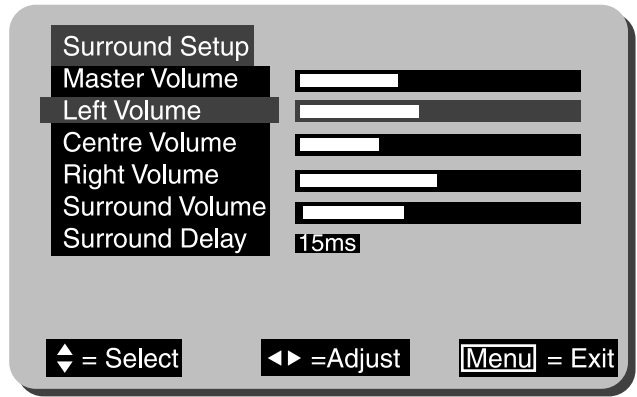

- 1 Press and **HOLD** the MENU button  until Main Menu with INSTALL is shown. Use up/down buttons  to highlight INSTALL - select by pressing the left/right buttons. 
- 2 Use up/down buttons  to **highlight** SURROUND SETUP, **select** by using the left/right buttons. 
- 3 Use the left/right/up/down buttons to adjust the values of your choice 
- 4 Repeatedly press MENU key to exit 



When the TV automatically cycles through the various sound channels, we suggest that you listen to the TV sound for a few moments before adjusting any of the channels. By doing this you may be able to determine which channel needs adjusting. Once you have adjusted the selected level, leave the TV to cycle through the Set-up menu a few times more, this will then determine whether you have applied the correct amount of volume level to the selected sound channel.

Surround Delay

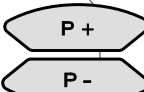
The Surround Delay mode enables the viewer to set the optimum surround sound delay from the TV. There are three levels to select and these are dependant on how close your viewing position is to the TV. Each setting is displayed as a millisecond value (ms) and are configured as 15ms, 20ms and 25ms. If you feel that your seating position is relatively close to the TV (example 1 below), then set the Surround Delay to 15ms. The 20ms setting should be used if you believe your seating position is midway between the TV and the rear sound source (example 2 below). Set the Surround Setup to 25ms if the seating position is relatively close to the rear sound source (example 3 below). Setting these modes is explained below. **Please note that 3DS should be de-activated before the Surround Delay mode is set.**

- 1 Enter the Surround Setup Menu as described above and select Surround Delay using the up/down cursor keys 
- 2 Use handset buttons left and right to select between 15, 20 and 25ms. 
- 3 Repeatedly press MENU key to exit 

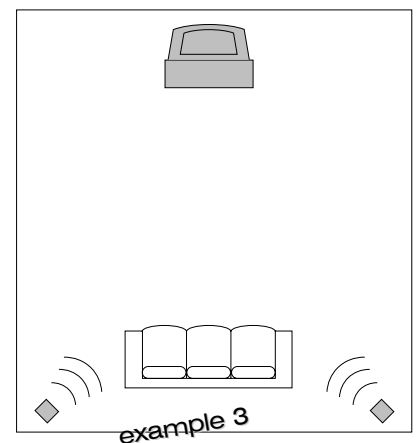
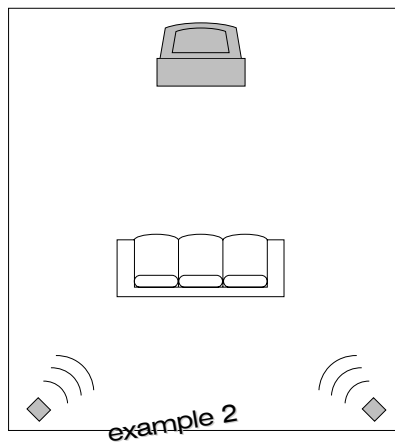
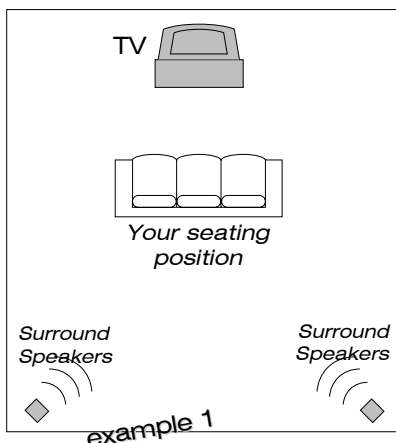
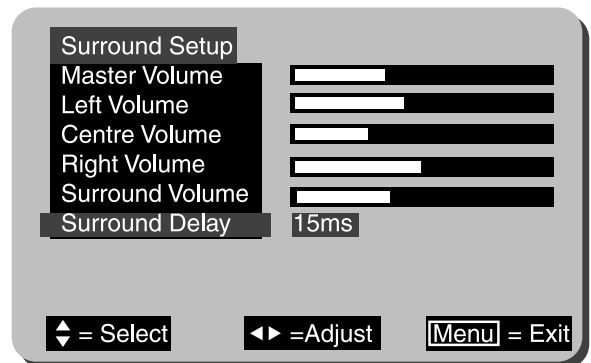

Connecting External Audio Equipment

If desired you may want to customise your TV by adding external surround speakers. This TV will accommodate external surround speaker systems via external sockets on the rear of the TV. The addition of external surround speakers will enhance your viewing and listening pleasure even further, and we strongly recommend you purchase HITACHI systems to compliment your HITACHI TV (contact your dealer for advice). The illustrations (below) will guide you on the correct installation and settings for external surround speaker set-ups. If you decide to purchase additional amplifiers and speakers then please follow these simple guidelines listed below:

1. If you have purchased just 2 amplifiers and speakers then these are best installed as rear surround speakers, as the TV will use its own internal speakers to create the front left, right and centre channels.
2. Please ensure that you purchase and install the correct rated range of amplifier and speaker for the TV - (front-centre speakers 10 Watt or greater) and (rear surround 5 Watt or greater). Your HITACHI dealer can advise you on the correct amplifier and speaker choice for your TV.

! IMPORTANT ! The 18V power output socket on the rear of this TV is specifically designed for Hitachi Accessories. Under no circumstances connect any other accessory to this socket, as this could cause serious irreparable damage to your equipment. Before attempting to connect any external equipment, ensure that the TV is switched OFF.

OPTION 1

Option 1 describes and illustrates the connection of Rear Surround Amplifiers & Speakers.

1. Switch off TV.
2. Connect Surround speakers as shown and position as indicated in the illustrations below.
3. Switch TV on.
4. Follow instructions in the '**Speaker Configuration Menu Section**' to obtain **Speaker Configuration Option**, and ensure Internal Speakers ARE NOT muted i.e (), also set Centre Channel to PHANTOM.
5. Use the Surround Set-up Menu to adjust the volume level on the Surround Speakers if required.

The TV uses internal speakers to provide left and right channels, and also creates its own centre channel. The rear surround speakers enhance your listening pleasure.

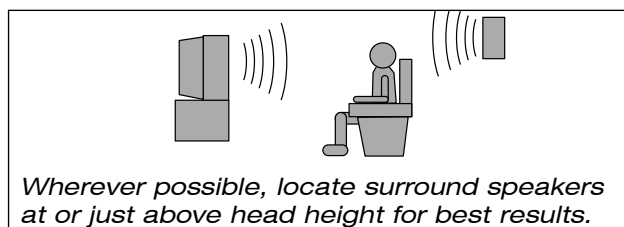
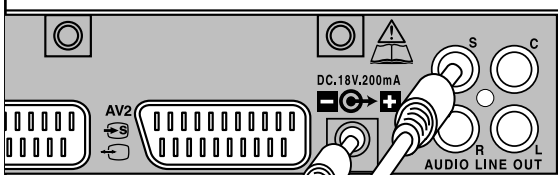

Surround Speaker & *Stand

Surround Speaker & *Stand

OPTION 2

Option 2 describes and illustrates the connection of Rear, Front and Centre Surround Amplifiers & Speakers.

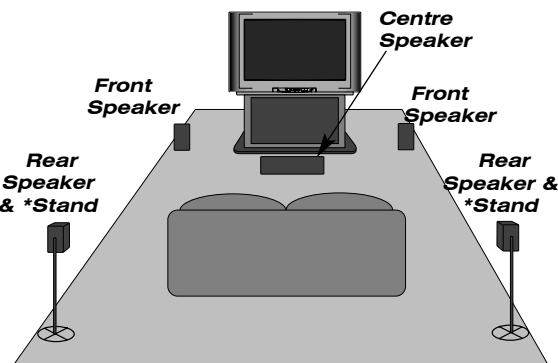
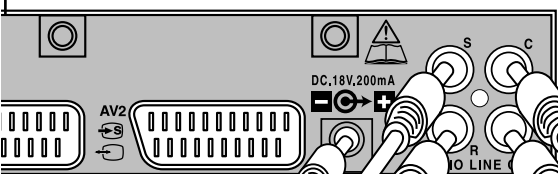

1. Switch off TV.
2. Connect Surround, Left, Right and Centre speakers as shown and position closely to illustration below.
3. Switch TV on.
4. De-activate 3DS and follow instructions in the '**Speaker Configuration Menu Section**' to obtain **Speaker Configuration Option**, and ensure Internal Speakers ARE muted i.e. (), also set Centre Channel to WIDE or NORMAL.
5. Use the Surround Set-up Menu to adjust the volume level on the Surround Speakers and Centre speaker if required.

In this configuration full Dolby Pro Logic Sound is achieved using 5 external speakers.

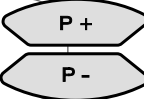

Solid Background

The Solid Background feature controls the appearance of the OSD (On Screen Display) window environment, with either a solid or transparent appearance to the OSD. There are two modes to select from and these are simply ON and OFF. Follow the guide below.

- 1 Press the MENU button on your handset until the MAIN MENU appears. 
- 2 Press the BLUE colour coded button to view FEATURE menu.
- 3 Select SOLID BACKGROUND mode by using the up/down buttons. 
- 4 Adjust the controls ON or OFF using the up or down handset buttons. Press MENU to exit. 

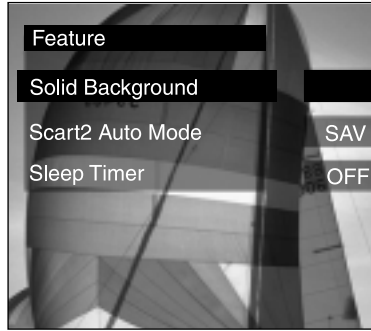

With Solid Background deselected the OSD window becomes transparent, allowing you to view the TV picture behind the OSD.

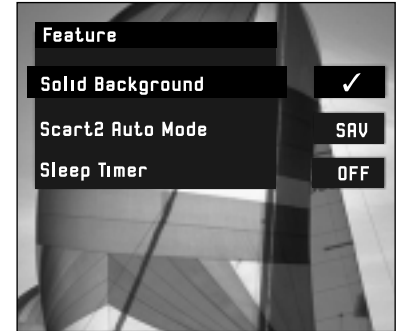

With Solid Background selected the OSD window becomes solid.

Scart2 Auto Mode

This feature is used to set the condition of Scart 2 Audio/Video input socket. If, for example, you regularly connect external equipment such as S-VHS (Super VHS) Video recorders or camcorders to AV2, then the TV can be set to SAV mode to accommodate such equipment. Standard AV mode can also be set if desired.

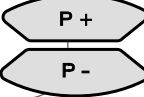
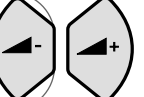
- 1 Press the MENU button on your handset until the MAIN MENU appears. 
- 2 Press the BLUE colour coded button to view FEATURE menu.
- 3 Select SCART2 AUTO MODE mode by using the up/down buttons. 
- 4 Adjust the controls by using the left or right handset buttons. Press MENU to exit. 

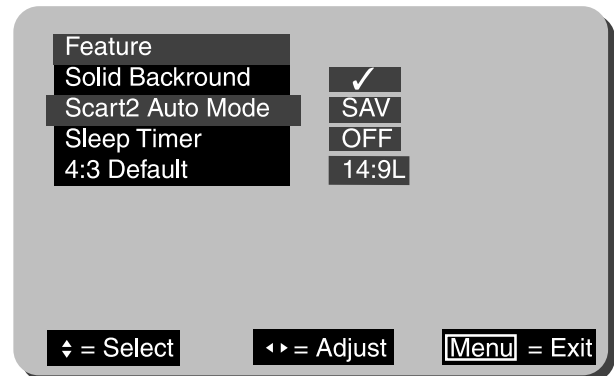

Sleep Timer Function

The Feature Menu also incorporates a Sleep Timer Facility. This allows the user to input a set amount of time before the TV automatically shuts down in to Stand by mode. The amount of time is input in 5 minute intervals, to a maximum of 120 minutes (2 hours). When there is only 60 seconds remaining a countdown appears in the top right hand corner of the screen.

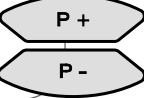
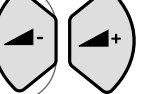
- 1 Press the MENU button on your handset until the MAIN MENU appears. 
- 2 Press the BLUE colour coded button to view FEATURE menu.
- 3 Select SLEEP TIMER mode by using the up/down buttons. 
- 4 Adjust the time value by using the left or right handset buttons. Press MENU to exit. 

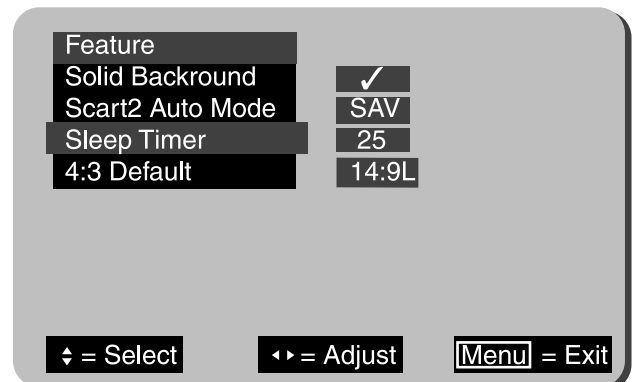

An example of the Sleep Timer function with 25 minutes entered is shown.

NOTE: The 4:3 default mode relates to Wide Screen modes. Please refer to the 'Wide Screen Modes Section' for instructions on settings

Wide Screen Modes

The various screen modes below and on 'Wide Screen Modes Section' are available on this model. Each of these modes are accessed using the 16:9 button  on your handset



example 1

AUTO

Auto mode automatically detects various screen formats that are transmitted in either conventional (4:3) or wide screen (16:9/14:9L). After detecting which signal is being transmitted the TV will automatically switch to the correct screen ratio.

In example 1 (left) a 4:3 conventional picture format is shown, note the black bars to the sides of the screen, this is consistent with screen compression.

4:3 mode can also be manually selected if desired.



example 2

Example 2 (left) illustrates a 16:9 Wide Screen picture format. This type of picture fills the entire TV screen. The 16:9 mode can also be manually selected if desired.



example 3

AUTO mode can also detect 14:9L ratio signals, when this mode has been selected thin black bars appear to the sides of the screen (example 3).

NOTE: Other screen formats may be transmitted by certain broadcasters, these are 14 x 9L True Wide Screen and 16 x 9L/14 x 9L with subtitles. Your TV is able to detect these formats and adjust the set automatically (subject to WSS transmitting).

Hitachi recommend that AUTO is selected for the majority of TV viewing.

NOTES: The function of the AUTO mode is dependent on whether the Wide Screen Signalling (WSS) is transmitting, check with your local operator for availability.

When WSS is not active the picture mode will default to the Feature settings (see 'Wide Screen Modes Section')

PANORAMIC

Panoramic mode emulates that of a Wide Screen broadcast for 4 x 3 transmissions. This is achieved by maintaining the proportions of the centre of the screen while extending the images on the sides of the screen (example 4).

This mode is generally recommended if AUTO is not selected.



example 4

MANUAL SETTINGS

Some modes can also be manually selected if some pictures appear distorted or stretched, or subtitle information becomes lost. Follow the guide below to apply the correct setting.



16 x 9L

The 16:9 Letterbox mode is used to expand a 16:9 letterbox style picture so that it uses the full screen to display the picture. Letterbox type pictures are identifiable by the black bars that appear on the top and bottom of the screen and some objects appear stretched (see example 5). Once selected, the 16:9L mode displays the picture as example 2 on 'Wide Screen Modes Section'.



14 x 9L

When viewing pictures in the 14:9L Letterbox mode (example 6) thin black bars appear at the top and bottom of the screen, and images become slightly elongated. By selecting 14:9L mode the user can expand the TV picture to display more of the screen (see example 3 above).



If viewing movies or programmes containing screen subtitles whilst in 16 x 9L or 14 x 9L modes, the subtitle may become lost to the bottom of the screen. To overcome this problem, simply press the SUBTITLE button  once. The SUBTITLE feature compresses the bottom of the screen allowing the subtitles to be viewed, as in example 7.

If, however, you wish to view Teletext subtitles a further press of the SUBTITLE button is required, this will then restore the screen to its original setting.



NOTE: Whatever Wide Screen mode was set before the TV is switched off will be the same condition when it is switched back on. The references to the Wide Screen modes are purely for guidance purposes only - your preferences may vary to those listed.

4:3 Default

The 4:3 default setting in the FEATURE Menu allows you to set which screen mode the TV defaults to when the AUTO function is selected but WSS (Wide Screen Signalling) is not transmitting. This allows the user to select between the various wide screen modes as a default.

1

Press the MENU button on your handset until the MAIN MENU appears.

MENU

2

Press the BLUE colour coded button to view FEATURE menu.

3

Select 4:3 DEFAULT mode by using the up/down buttons.

P +

P -

4

Adjust the time value by using the left or right handset buttons. Press MENU to exit.

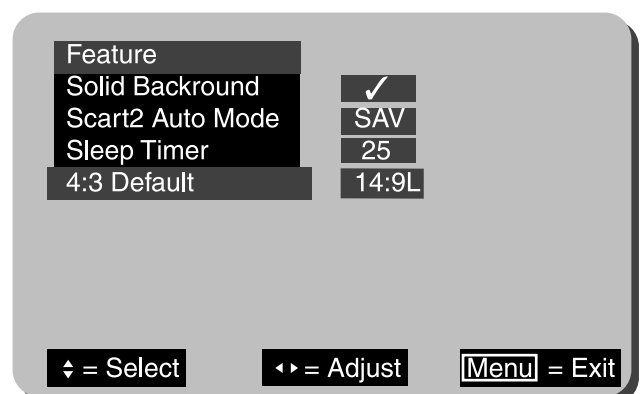
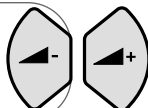

Connecting External AV Equipment

Your TV has various input sockets for external equipment such as Video Cassette Recorders, Satellite Receiver/Decoder, Camcorders, Computer Equipment etc.. Equipment that is connected temporarily i.e. Camcorders can be connected via the front control panel input sockets. However, equipment such as VCR's and Satellite IRD's, that are more or less permanently connected to your TV, are connected via the AV1 or AV2 scart sockets on the rear of the TV.

CAMCORDER CONNECTION: Connecting a camcorder to your TV is simple. Firstly, identify the type of camcorder and it's connecting plugs. If it is a standard 8mm type camera then it is likely to have 'RCA' type sockets. If, however, you have S-VHS or Hi8 type camera then this may have a S-VHS/Hi8 plug, and this will have to be placed in the corresponding S-VHS/Hi8 socket on the TV. Open the front control panel door on the TV, and connect your equipment as shown in the illustration below. Switch your TV on, and repeatedly press the TV/AV (→) button on your handset until AV3 or SAV3 (for S-VHS equipment) is displayed on-screen. Now begin playback operation of your equipment.

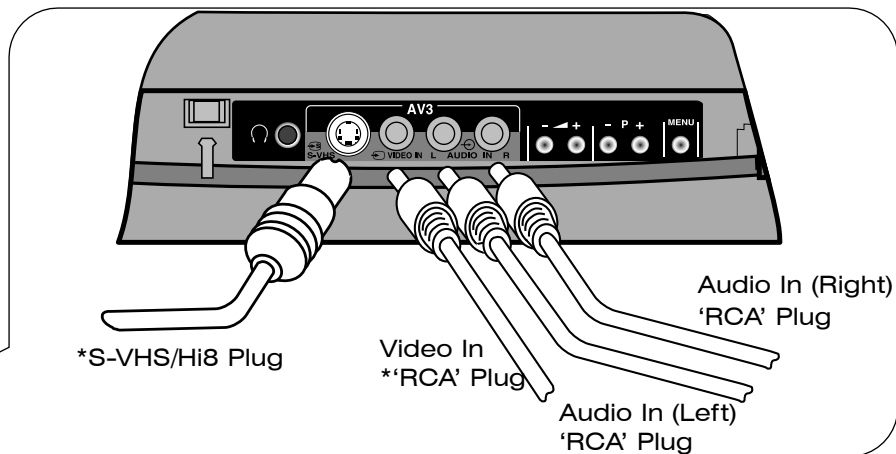

* If your camcorder has both S-VHS/Hi8 and 'RCA' type plugs, then connect all plugs except the Video In 'RCA' plug.

COMPUTER EQUIPMENT: If computer equipment is to be connected to this TV, use AV1 as the RGB input socket located on the rear of the TV and select RGB using the RED colour coded key on your handset.)

PLEASE NOTE: Prolonged use of computer equipment or games on this TV may cause permanent damage to your picture tube. To avoid such damage, reduce the brightness and contrast to an acceptable minimum level and limit the duration of equipment operation.

SATELLITE CONNECTION: There are two basic methods of connecting a satellite system to your TV. Method 1 explains connection of satellite equipment directly to the TV, where as Method 2 refers to connection via a VCR.

METHOD 1

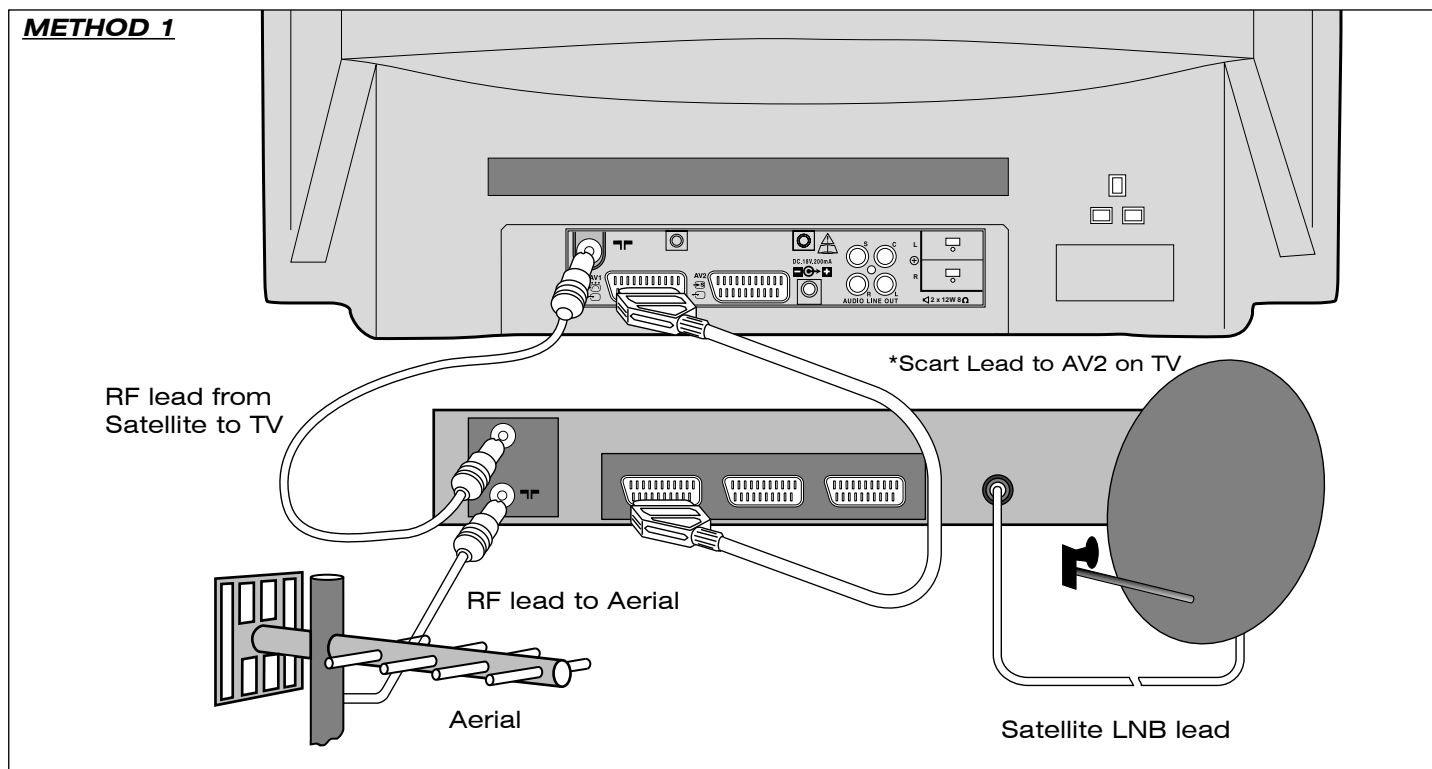

METHOD 2

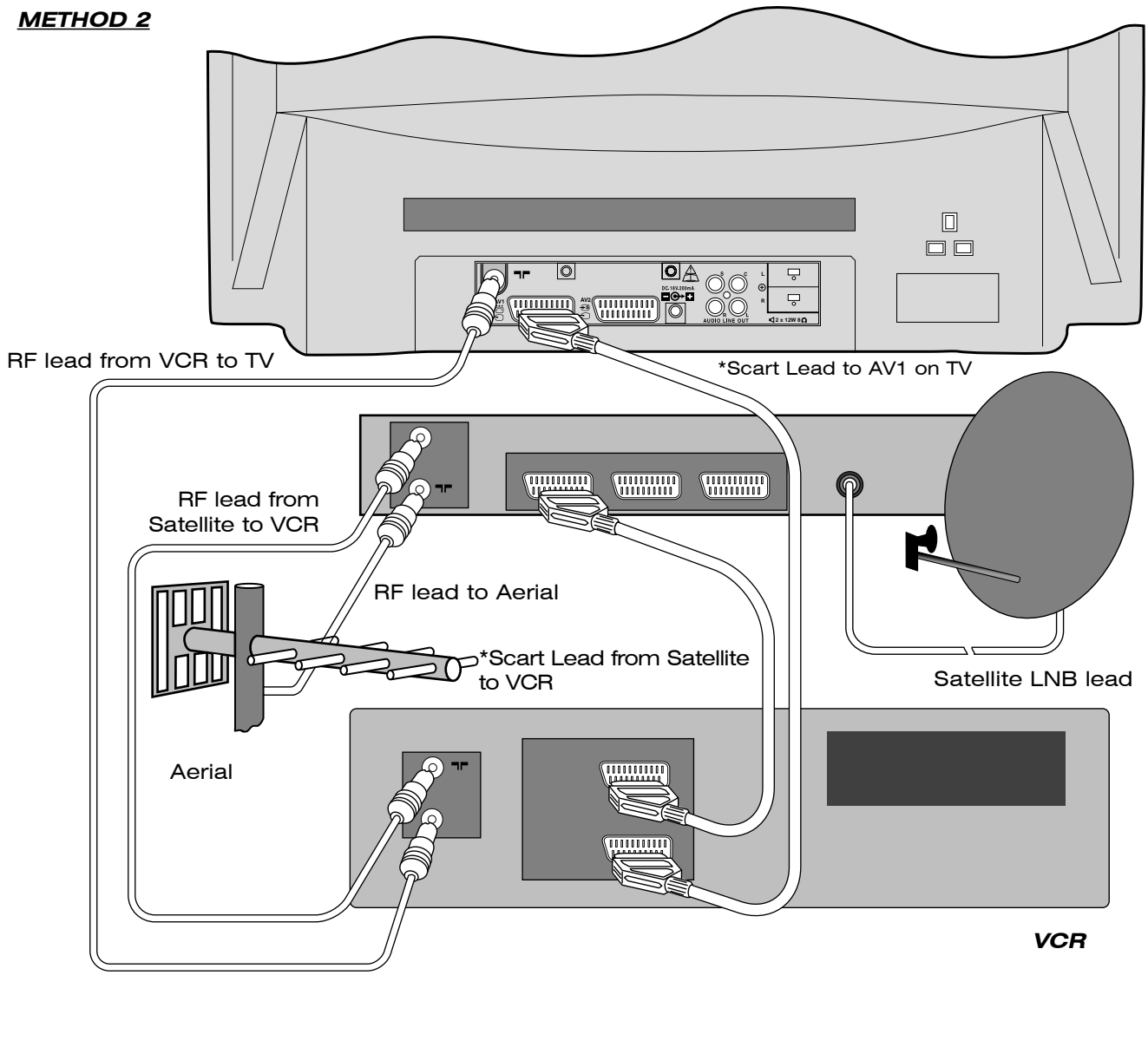

NOTE: S-VHS video equipment should be connected to the AV2 Scart socket located on the rear of the TV. A dedicated program number may then be assigned to AV2, allowing easier access to view external equipment broadcasts. How to assign AV sockets to dedicated program numbers is explained in the **'Manual Tuning Section'**. Alternatively, repeatedly press the TV/AV button on your handset until SAV2 is displayed on-screen. Now begin playback operation of your equipment.

HEADPHONE CONNECTION:

To use headphones with this TV, simply open the front control cover door and insert the headphone jack plug (3.5mm) into the corresponding socket marked . The TV sound will then be switched to the headphones.

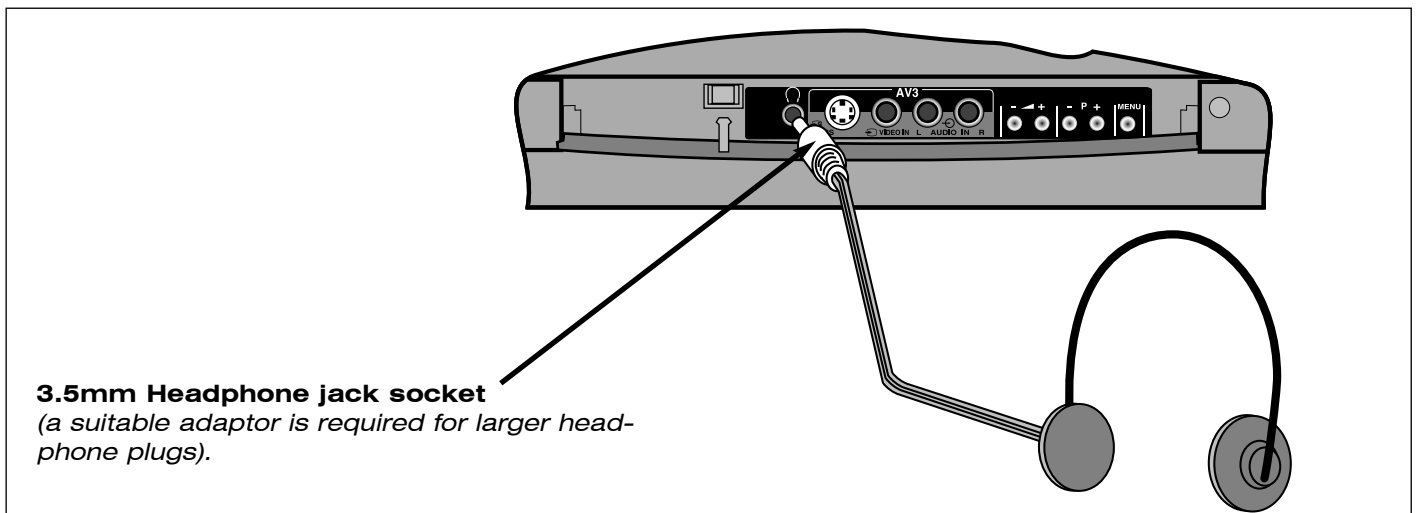

Handset Controls

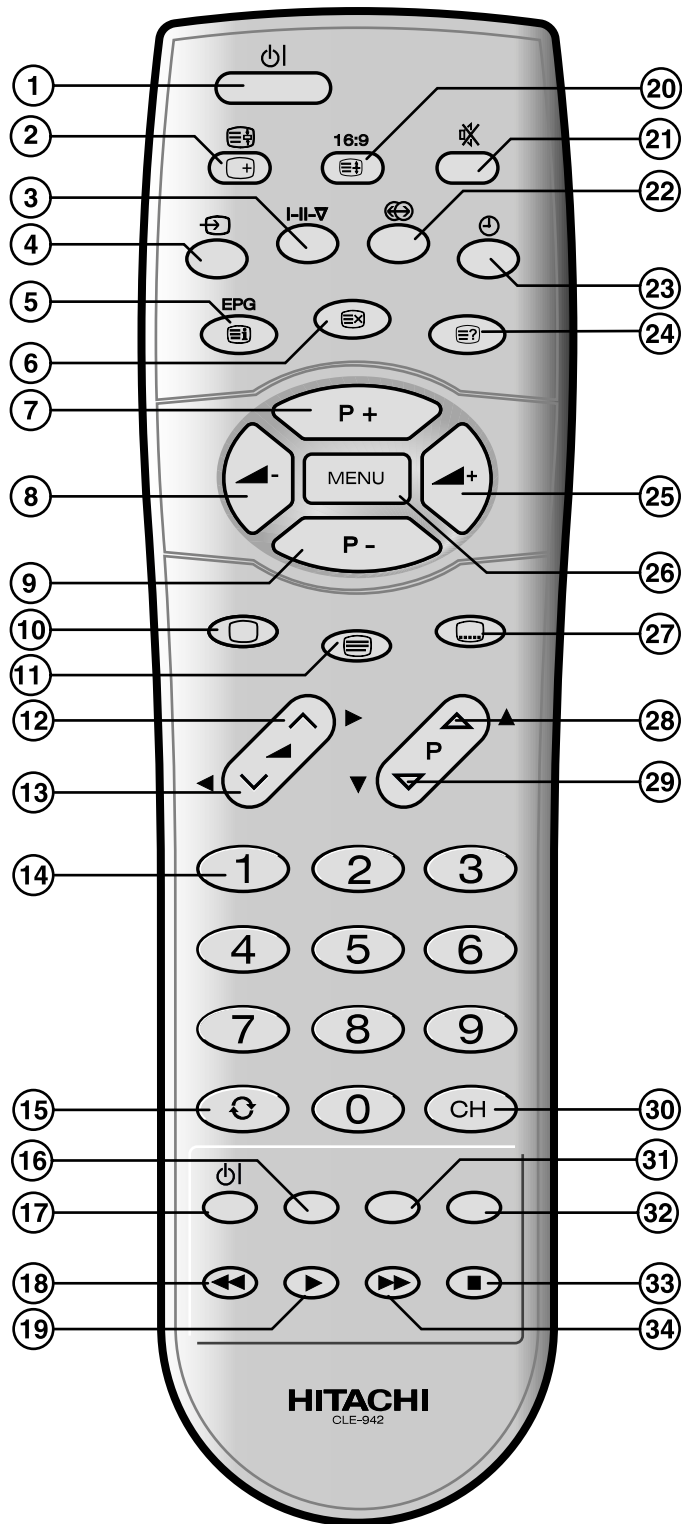

The remote control handset supplied has several different functions. These functions are mainly used for operations whilst in teletext mode. The Teletext modes and functions are in ***bold italic type*** and all functions are briefly explained opposite.

Handset Functions

TELETEXT FUNCTIONS ARE SHOWN IN BOLD ITALIC TYPE.		
1	Stand-by button	Used to switch the TV on and off for short periods of time.
2	Recall/Hold	Press Recall to view current TV status. Press Hold to freeze Teletext page.
3	Dual Language	This button allows the user to select a dual language function (subject to availability) and switches from Mono to Stereo reception, it also has a colour coded teletext function and OSD† function.
4	AV Input	The TV/AV button allows the user to select either a TV or external source signal i.e. a camcorder etc.. This button also has a colour coded teletext function and OSD† function.
5	EPG/Index	The INDEX function is used whilst in Fastext mode and displays the magazine page on view. The EPG function is not available on this model.
6	Update	The Update button restores the TV screen whilst a Teletext page is searched.
7	P+/Cursor up	When in normal TV operation this button allows the user to step up programme numbers in sequence. In MENU mode this button is the cursor up key.
8	Vol-/Cursor left	When in normal TV operation this button allows the user to reduce the TV volume. In MENU mode this button is the cursor left key.
9	P-/Cursor Down	When in normal TV operation this button allows the user to step down programme numbers in sequence. In MENU mode this button is the cursor down key.
10	Television	This enables the viewer to return to normal TV operation.
11	Teletext	When pressed this button enables the Teletext service.
12	Volume up	When in normal TV operation this button allows the user to increase the TV volume. In MENU mode this button is the cursor right key.
13	Volume down	When in normal TV operation this button allows the user to decrease the TV volume. In MENU mode this button is the cursor left key.
14	Digits 0 to 9	Used for direct programme selection (enter a second digit within 2 seconds for programme numbers above 10 i.e. to obtain programme number 29 enter 2 and then 9). Teletext 3 digit entry.
15	Swap	In TV mode swaps between previous and current programme numbers. In Teletext mode this feature allows the user to recall the last 4 Teletext pages.
16		NO FUNCTION
17	Video Stand-by	Used to switch the VCR on and off for short periods of time.
18	Rewind	Press to rewind a VCR tape.
19	Play	Press to play a VCR tape.
20	16:9/Expand	Used to select between Wide Screen formats. Used to expand text pages.
21	Mute	This feature allows the user to mute the sound temporarily.
22	Stereo	Press to select between Stereo Normal and Stereo Wide modes, also has a colour coded teletext function and OSD† function.
23	Clock	This button allows the user to display the current time on-screen, also has a colour coded teletext function and OSD† function.
24	Reveal	Used whilst in Teletext mode to reveal hidden pages i.e. quiz pages etc.
25	Vol+/Cursor Right	When in normal TV operation this button allows the user to increase the TV volume. In MENU mode this button is the cursor right key.
26	Menu	The MENU button when pressed allows the user to access the TV's menu system.
27	Subtitles	Allows the user to access a subtitle service directly (subject to Subtitle service broadcasting).
28	Program up	When in normal TV operation this button allows the user to step up programme numbers in sequence. In MENU mode this button is the cursor up key.
29	Program Down	When in normal TV operation this button allows the user to step down programme numbers in sequence. In MENU mode this button is the cursor down key.
30	Frequency	Allows the user to directly input known broadcasting CH or frequency numbers.
31		NO FUNCTION
32		NO FUNCTION
33	Stop	Press to stop the VCR tape.
34	Forward	Press to fast forward a VCR tape.

† OSD (On Screen Display).

Teletext Operation

Teletext operation is entered by pressing the TEXT button  on your handset.

A page similar to the one shown on the right will appear. The main page contains numbered topics that are accessed by entering the corresponding three digit code on your handset.

In addition to the above system, at the bottom of the page there are four colour coded popular topics i.e. TV Guides, Weather, Sport etc., however, these may vary between each broadcasting station. To access these topics simply press the corresponding colour coded keys on your handset .

By pressing the P+ or P- keys you may step up or down a page respectively.

If a mistake occurs while entering a number then simply re-enter the desired number.

FAVOURITE PAGE OPTIONS

The TV is capable of storing up to 4 favourite pages. These pages could be your favourite sport or TV page etc., and are accessed by pressing one of the colour coded keys on your handset.

To enter a favourite page first access the TEXT mode by pressing the TEXT key on the handset. Now enter the favourite page mode by pressing the MENU button on your handset (the MENU button allows the user to toggle between FASTEXT and FAVOURITE PAGE modes).

Enter the colour coded key you wish to use as the first favourite page..

Now enter the page number you wish to assign to the desired colour coded key using the 0-9 buttons on your handset.

Once you have completed this step you must now store your selection in the TV's memory. Simply press and hold the selected colour coded key until the entire bottom fastext bar turns white. This is now stored.

If desired, another three favourite pages may be entered by following the above method, utilising the existing colour coded keys.

To view a Favourite Page simply press the MENU key whilst in FASTEXT and press the desired stored page using the Colour Coded keys on the handset.



P100 CEEFAX 2 100 Wed 19 Mar 15:49/06			
BBC		CEEFAX	
CEEFAX AT-A-GLANCE PRESS HOLD			
NEWS HEADLINES	101	LOTTERY	555
NEWS INDEX	102	BACKBEAT	560
ELECTION 97	120	FREETIME	570
NEWS EXTRA	140	GARDENING	573
CITY BBC2	200	COOKBOOK	580
SPORT	300	ON THE BOX	590
WEATHER	400	TV GUIDE	600
TRAVEL	430	TV LINKS	615
CBBC INDEX	500	RADIO BBC1	640
SUB ZERO	501	EDUCATION BBC2	630
NEWSOUND	510	READ HEAR BBC2	640
SHOWTIME	520	COMMUNITY BBC2	630
SWITCHED ON	540	RACING	660
NEWS EXTRA NEWS EXTRA NEWS EXTRA			
Home 141	World 142	Politics 143	
News Heads	Sport	TV/Radio	Weather

The 4 Fastext Topics are shown on the bottom of the screen

VCR Operation



Your handset incorporates controls for operation of HITACHI Video Cassette Recorders. These controls are STAND-BY, PLAY, STOP, FAST FORWARD, and REVERSE, and are located on the bottom of the handset.

To switch your VCR on or off simply press the VCR Standby button 

To halt a cassette tape press the STOP button 

To rewind a cassette tape press REW button 

To begin playback of a cassette tape press the PLAY button 

To fast advance a cassette tape press F/FWD button 

The guide below is intended to help the user to identify common problems which may be encountered during the setup of this TV. If a problem still exists after referring to this guide, please consult your dealer immediately. Under no circumstances remove the rear cover of this TV. There are no user serviceable parts inside and you will be exposed to high voltages, which could cause a severe or fatal electric shock.

Q) My TV fails to switch on.





A) Check that plug is connected to socket and switched on. Check fuse and make sure TV is not in Stand-by mode (see below).

Q) My remote control handset does not work.

A) Ensure there are no obstructions between the handset and the TV infra red lens, or the batteries may be exhausted - replace with new.

Q) The handset won't control my VCR.

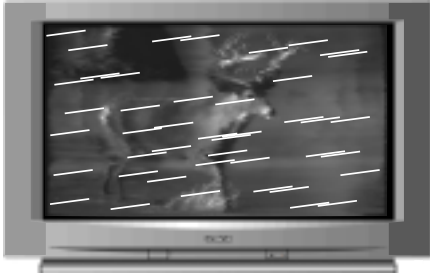
A) The handset is only programmed to operate Hitachi VCR's.

Problem Identification	Possible Reason	Remedy
 Snowy Picture - Poor Sound	<p><i>Aerial has moved out of position</i></p> <p><i>Corroded or poor aerial connections.</i></p> <p><i>Connection of RF lead to TV poor.</i></p> <p><i>Adverse weather conditions.</i></p> <p><i>Transmitter problems.</i></p>	<p><i>Re-align aerial.</i></p> <p><i>Make new connections or renew lead.</i></p> <p><i>Make new connection and/or change RF plug.</i></p> <p><i>None.</i></p> <p><i>Check with local Operator.</i></p>
 Multiple Images - Sound OK	<p><i>Aerial has moved out of position.</i></p> <p><i>TV not tuned correctly.</i></p> <p><i>Adverse weather conditions.</i></p> <p><i>Transmitter problems.</i></p>	<p><i>Re-align aerial.</i></p> <p><i>Re-tune or Fine tune TV.</i></p> <p><i>None.</i></p> <p><i>Check with local Operator.</i></p>
 Intermittent Interference	<p><i>Magnetic interference from electrical or mechanical motors, fluorescent lights, portable radios etc..</i></p>	<p><i>Check devices for shielding and renew if necessary or move further from TV.</i></p>
 No Picture and/or No Sound	<p><i>TV may be in AV mode.</i></p> <p><i>TV in Stand-by.</i></p> <p><i>Picture/Sound controls set to minimum.</i></p> <p><i>Aerial plug removed from TV socket</i></p> <p><i>Incorrect Speaker mode selected</i></p>	<p><i>Press AV/RED button repeatedly or 0-9 buttons to return to TV mode.</i></p> <p><i>Press 0-9 buttons.</i></p> <p><i>Check Picture/Sound controls.</i></p> <p><i>Re-plug aerial lead to socket.</i></p> <p><i>Ensure the correct Speaker Configuration is selected.</i></p>

Guarantee

Thank You for purchasing this Hitachi Television.

In the unlikely event that this product should develop a fault, we undertake to repair or replace any part of the product which fails due to a manufacturing defect within 12 months of the date of purchase provided that...

1. the product has been installed and used only in accordance with the instructions supplied with the product.
 2. the product has not been repaired, maintained, or modified by any person other than a Hitachi authorised dealer.
 3. the product serial number has not been removed or altered.
- this guarantee does not apply to a product acquired second hand or for commercial or communal use.
 - this guarantee does not cover the replacement of exhausted batteries, the adjustment of user controls, or aerial alignment.
 - any parts replaced under this guarantee shall become the property of Hitachi Home Electronics (Europe) Ltd,
 - please note that evidence of the date of purchase will be required before any service under this guarantee is carried out

Use the boxes provided below to record your TV's Model and Serial Number - these are found on the rating plate located on the rear of the TV. Also, record where and when you purchased this T.V. This information will help any future queries you may have and should be used in all correspondence with Hitachi service centres.

MODEL

SERIAL NUM-
BER

DEALER/STORE

DATE PUR-
CHASED

This guarantee does not affect your statutory rights.

*In all cases of difficulty please
consult your Hitachi dealer.*

TV Standard.....	625 line single standard
Channel Coverage.....	UHF channels
Aerial Impedance.....	75 W unbalanced
Picture Tubes.....	28" - 66 cm type 32" - 76 cm type
Mains Voltage.....	220 - 240V AC 50 Hz
Internal Speakers.....	6 x 12 cm type x 2
Power Consumption..... (All Models Stand by <6W)	C28W510/511SN/TN model 120W approx. C28WD2TN2 model 120W approx. C32W510/511SN/TN model 130W approx. C32WD2TN2 model 130W approx.
Weight.....	C28W510/511SN/TN model 34 kg approx C28WD2TN2 model 36 Kg approx C32W510/511SN/TN model 51 Kg approx C32WD2TN2 model 51 Kg approx
Dimensions (W x D x H).....	C28W510/511SN/TN model 790 x 525 x 515 C28WD2TN2 model 782 x 515 x 495 C32W510/511SN/TN model 879 x 569 x 554 C32WD2TN2 model 879 x 569 x 554
Remote Control Batteries.....	2 x HITACHI SUM-3 /equivalent AA

Specifications are subject to change without notice. Weight and dimensions shown are approximate.

Software Notice

It is prohibited for the end user of this product to copy, reverse engineer or reverse compile the software included therein save to the extent permitted by law.

SCART SOCKET AV1

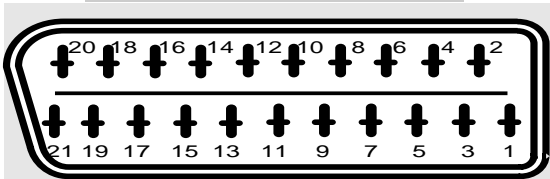

PIN No.	FUNCTION
1	AUDIO OUT (RIGHT)
2	AUDIO INPUT (RIGHT)
3	AUDIO OUT (LEFT)
4	GROUND (AUDIO)
5	GROUND (BLUE)
6	AUDIO INPUT (LEFT)
7	BLUE INPUT
8	SWITCHING INPUT
9	GROUND (GREEN)
10	NOT USED
11	GREEN INPUT
12	NOT USED
13	GROUND (RED)
14	GROUND (BLANKING)
15	RED INPUT
16	STATUS (BLANKING) INPUT
17	GROUND (VIDEO)
18	GROUND (VIDEO)
19	COMPOSITE VIDEO OUTPUT
20	COMPOSITE VIDEO INPUT
21	GROUND

SCART SOCKET AV2

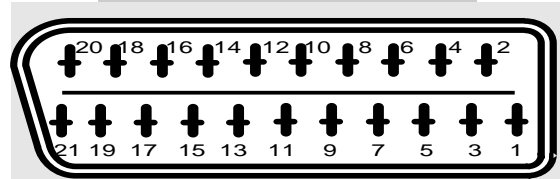

PIN No.	FUNCTION
1	AUDIO OUT (RIGHT)
2	AUDIO INPUT (RIGHT)
3	AUDIO OUT (LEFT)
4	GROUND (AUDIO)
5	NOT USED
6	AUDIO INPUT (LEFT)
7	NOT USED
8	SWITCHING INPUT
9	NOT USED
10	NOT USED
11	NOT USED
12	NOT USED
13	CHROMINANCE GROUND
14	NOT USED
15	CHROMINANCE INPUT S-VHS
16	NOT USED
17	GROUND (VIDEO)
18	GROUND (VIDEO)
19	COMPOSITE VIDEO OUTPUT
20	COMPOSITE VIDEO OR
21	COMPOSITE LUMINANCE S-VHS GROUND

S-VHS SOCKET

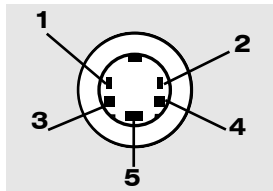

PIN	FUNCTION
1	Chrominance input
2	Luminance input
3	Chrominance ground
4	Luminance ground
5	Frame ground

HITACHI

Environmental Notice

Hitachi are signatories to the commitment made by the consumer electronics industry on reducing energy consumption by televisions and video recorders on standby.

Even though your TV has a low power consumption, you can reduce waste to zero if you switch off the set at the mains after use. Your TV should certainly be switched off overnight or when you are away from home. Other factors should also be considered when operating your TV. Reducing volume settings to sensible levels can reduce power consumption as well as reducing noise pollution, and reducing contrast can provide a more pleasing picture as well as reducing power consumption.

Hitachi Home Electronics (Europe) Ltd. manufacturing site in Wales is a BSI Registered Company, and has been assessed to ISO 9001 Quality Management Standard, certificate FM32366. Your television has been manufactured under the Environmental Quality Management Standard ISO14001, certificate EMS 36168.

The paper used for this Users Guide has been produced from sustainable forests, part of Hitachi's on going commitment to the global environment.

HITACHI

Hitachi, Ltd. Tokyo, Japan
International Sales Division
THE HITACHI ATAGO BUILDING,
No. 15-12 Nishi Shinbashi, 2-Chome,
Minato-Ku, Tokyo 105-8430, Japan.
Tel: 03 35022111

HITACHI EUROPE LTD,

Whitebrook Park
Lower Cookham Road
Maidenhead
Berkshire
SL6 8YA

UNITED KINGDOM

Tel: 01628 643000
Fax: 01628 643400
Email: consumer-service@hitachi-eu.com

HITACHI EUROPE S.A.

364 Kifissias Ave. & 1, Delfon Str.
152 33 Chalandri
Athens

GREECE

Tel: 1-6837200
Fax: 1-6835964
Email: service.hellas@hitachi-eu.com

HITACHI EUROPE GmbH

Munich Office
Dornacher Strasse 3
D-85622 Feldkirchen bei München

GERMANY

Tel: +49-89-991 80-0
Fax: +49-89-991 80-224
Hotline: +49-180-551 25 51 (12ct/min)
Email: HSE-DUS.service@hitachi-eu.com

HITACHI EUROPE S.A.

Gran Via Carlos III, 101-1
08028 Barcelona

SPAIN

Tel: 93 409 2550
Fax: 93 491 3513
Email: atencion.cliente@hitachi-eu.com

HITACHI EUROPE srl

Via Tommaso Gulli N.39, 20147
Milano, Italia

ITALY

Tel: +39 02 487861
Tel: +39 02 38073415 Servizio Clienti
Fax: +39 02 48786381/2
Email: customerservice.italy@hitachi-eu.com

HITACHI Europe AB

Box 77 S-164 94 Kista

SWEDEN

Tel: +46 (0) 8 562 711 00
Fax: +46 (0) 8 562 711 13
Email: csgswe@hitachi-eu.com

HITACHI EUROPE S.A.S

Lyon Office
B.P. 45, 69671 BRON CEDEX

FRANCE

Tel: 04 72 14 29 70
Fax: 04 72 14 29 99
Email: france.consommateur@hitachi-eu.com

HITACHI EUROPE LTD (Norway) AB

STRANDVEIEN 18

1366 Lysaker

NORWAY

Tel: 67 5190 30
Fax: 67 5190 32
Email: csgnor@hitachi-eu.com

HITACH EUROPE AB

Egebækgård
Egebækvej 98
DK-2850 Nærum

DENMARK

Tel: +45 43 43 6050
Fax: +45 43 60 51
Email: csgnor@hitachi-eu.com

HITACHI EUROPE AB

Neopoli / Niemenkatu 73
FIN-15140 Lahti

FINLAND

Tel : +358 3 8858 271
Fax: +358 3 8858 272
Email: csgnor@hitachi-eu.com

Hitachi Europe Ltd

Bergensesteenweg 421
1600 Sint-Pieters-Leeuw

BELGIUM

Tel: +32 2 363 99 01
Fax: +32 2 363 99 00
Email: sofie.van.bom@hitachi-eu.com

HITACHI EUROPE LTD

Na Sychrove 975/8
101 27 Praha 10 – Bohdalec

CZECH REPUBLIC

Tel: +420 267 212 383
Fax: +420 267 212 385
Email: csgnor@hitachi-eu.com

www.hitachidigitalmedia.com