

**MISURO HD LCD TV
WITH DVD PLAYER**

GLCD3206HDV Series

The Gold Technical Support Line: 1902 215 259

Personal Product Support

(Charges will apply at \$2.95 per minute)

GERMIG

Introduction

Thank you for buying this Grundig product, which is designed to give you many years of trouble-free service.

You may already be familiar with using a similar unit, but please take time to read these instructions. They are designed to familiarize you with the unit's many features and to ensure you get the very best from your purchase.

Safety is important

Your safety and the safety of others is important.

Therefore, please ensure you read the "Safety Instructions" **before** you operate this unit.

Warranty

In the unlikely event that your product fails to work normally, please call the below free phone number to discuss the problem with one of our qualified service engineers.

Australia.

Grundig Warranty: 1800 509 394

New Zealand

Grundig Warranty: 0800 450 259

Contents

Introduction	1
Safety Instructions	3
Unpacking	5
TV/Monitor Stand Installation Guidelines	6
Wall Mount Bracket Installation Guidelines	7
View of TV/Monitor	8
Remote Control	10
Installation and Connection	13
TV/Monitor Screen Operation	14
TV Channel Menu and Adjustment	16
DVD Player Operation	26
Other Operation	36
Notes	38
Maintenance	39
Specifications	40
Display Modes	41
Warranty	42

Safety instructions

1. Do not use this apparatus near water.
2. Clean only with a dry cloth.
3. Do not block any ventilation openings. Install in accordance with the manufacturers instructions.
4. Do not install near any heat sources such as radiators, heat registers, stoves, or other apparatus (including amplifiers) that produce heat.
5. Protect the power cord from being walked on or pinched particularly at plugs convenience receptacles, and the point where they exit from the apparatus.
6. Only use attachments/accessories specified by the manufacturer.
7. Unplug this apparatus during lightning storms or when unused for long periods of time.
8. Refer all servicing to qualified service personnel. Servicing is required when the apparatus has been damaged in any way, such as power-supply cord or plug is damaged, liquid has been spilled or objects have fallen into apparatus, the apparatus has been exposed to rain or moisture, does not operate normally, or has been dropped.
9. The apparatus should not be exposed to dripping or splashing and no objects filled with liquids, such as vases, should be placed on the apparatus.
10. If the television is to be built into a compartment or similar enclosed space, the minimum distances must be maintained. Heat build-up can reduce the service life of your television, and can also be dangerous.

Installation notes









- This TV can be connected to AC 110-240 Volts. 50/60 Hz. Never connect to a DC supply or any other power supply.
- Locate the TV in the room where light does not strike the screen.
- Total darkness or a reflection on the picture screen can cause eyestrain. Soft and indirect lighting is recommended for comfortable viewing.
- Allow enough space between the TV and the wall to permit ventilation.
- Avoid excessively warm locations to prevent possible damage to the cabinet or premature component failure.
- Do not cover the ventilation openings when using the TV.

Additional Safety notes

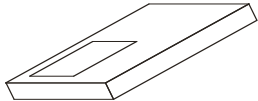
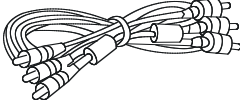
- Never tamper with any components inside the TV, or any other adjustment controls not mentioned in this manual.
- All LCD TVs are high voltage instruments. When you clean up dust or water drops on the LCD PANEL or CABINET, the power cord should be pulled out from the receptacle, then wipe the TV with a dry soft cloth.
- During thunder and lightning, unplug the power cord and antenna cord to prevent damage to your TV.
- All repairs to this TV should only be performed by qualified TV service personnel.

Unpacking

Please make sure that the following items are included with your LCD TV/Monitor. If any item is missing, please contact the warranty line.

 <p>TFT LCD TV/ Monitor</p>	
 <p>Remote control</p>	 <p>Operation manual</p>
 <p>RCA cable</p>	 <p>Power cord</p>
 <p>Stand Support</p>	 <p>Stand</p>
 <p>Screws (a Type 4 x14 mm)</p>	 <p>Screws (b Type 4 x16mm)</p>

TV/Monitor Stand Installation Guidelines

1. Fixing the Support to the Stand by screws (3 pieces a type screws 4 x14 mm) as below figure:

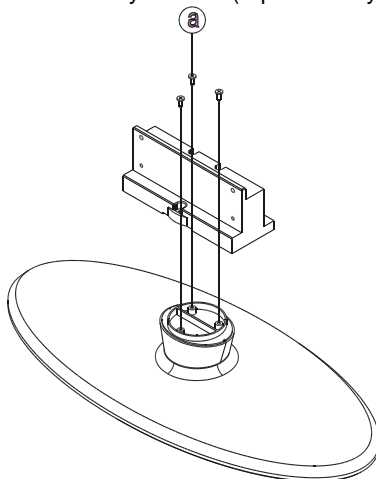

2. Fixing the finished Stand Assy. to the TFT LCD TV Unit by screws (4 pieces b type screws 4 x16mm) as below figure:

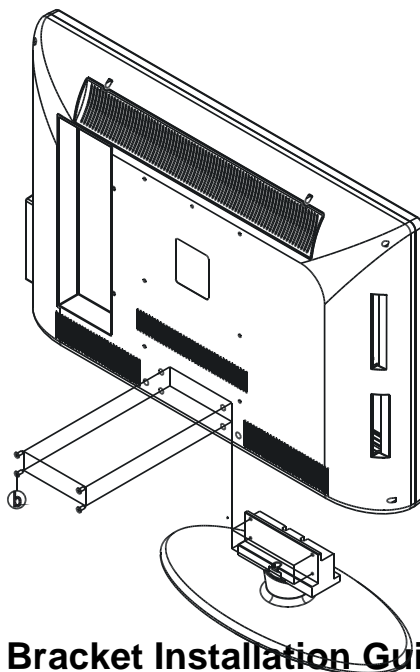

Wall Mount Bracket Installation Guidelines

1. Fixing the Support to the TFT LCD TV Unit by screws (4 pieces b type screws 4 x16mm) as below figure:

2. Using 6 screws to fix the TFT LCD TV Unit on the Wall Mount Bracket.
Please find there are 6 holes on the back of the unit.

I. View of the TV/Monitor

Front view

Back view

1. **Remote sensor**
To receive remote signal from remote control.
2. **STANDBY button / power indicator**
Turn the TV on and into standby mode, in power on mode the indicator will turn to blue and in standby mode the indicator will turn to red.
3. **PLAY/PAUSE button**
To play/pause playback of disc.
4. **STOP button**
To stop playback of disc.
5. **EJECT/CLOSE button**
To eject a disc from the disc slot or load a disc to the player
6. **VOL- button**
To decrease the volume level.
7. **VOL+ button**
To increase the volume level.
8. **CH- button**
To select channels downward in TV mode.
9. **CH+ button**
To select channels upward in TV mode.
10. **MENU button**
To enter menu mode.
11. **SOURCE button**
To select input source.
12. **DVD disc slot**
To load disc for playback.
13. **HDMI 2**
14. **HDMI 1**
15. **PC audio in**
16. **VGA input jack**
To connect to a PC.
17. **Pr input**
18. **Y input**
19. **AV2 video input**
20. **AV2 audio input (Right)**
21. **AV2 audio input (Left)**
22. **AV1 video input**
23. **AV1 audio input (Right)**
24. **AV1 audio input (Left)**
25. **S-Video**
26. **Pb input**
27. **YPbPr audio input (Right)**
28. **YPbPr audio input (Left)**
29. **AV OUT video output**
30. **AV OUT audio output (Right)**
31. **AV OUT audio output (Left)**
32. **COAXIAL OUT**
To connect the input socket on your surround sound system, this jack only output the SPDIF/PCM
33. **ANTENNA jack**
To connect the external aerial.
34. **AC INPUT (AC110~240V 50/60Hz)**

II. Remote Control

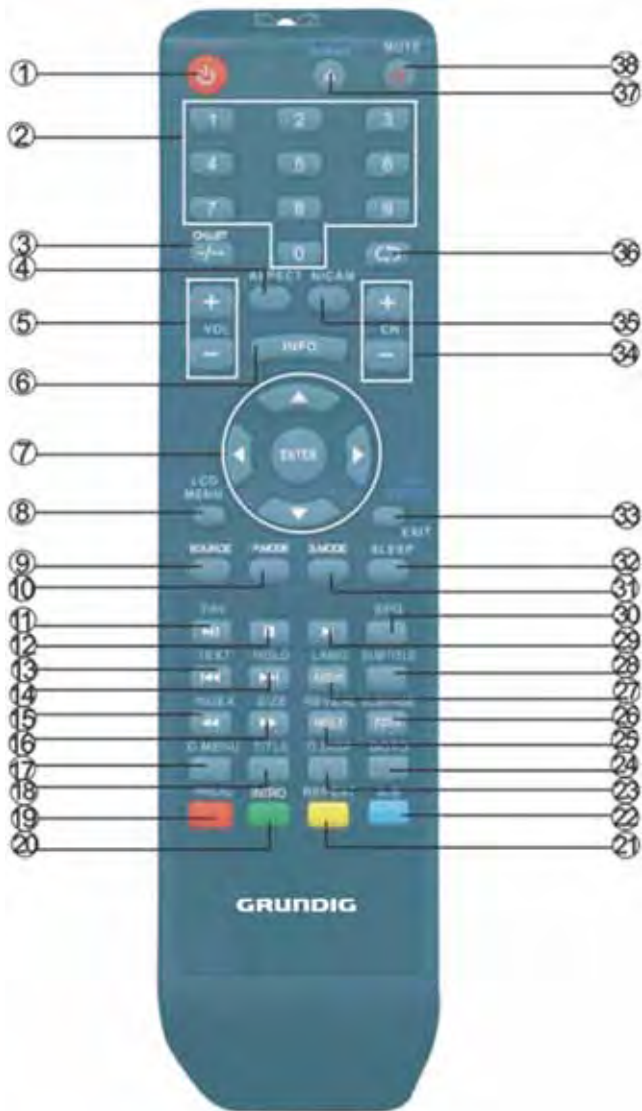

(1) Remote control keys function

- 1. STANDBY:** Turn the TV on and into standby mode.
- 2. Numeric buttons:** To select a channel by number input or input numbers in menus.
- 3. CH.LIST:** To show the channel list and used to input the track number for discs that have more than 9 tracks.
- 4. ASPECT:** To switch the size of the picture.
- 5. VOL+/-:** To adjust the volume up or down.
- 6. INFO:** To display the source and channel's information.
- 7. Navigation buttons:** To select the items of on-screen menus.
- 8. LCD MENU:** To display LCD OSD Menu
- 9. SOURCE:** To display INPUT source.
- 10. P.MODE:** To select the picture mode.
- 11. PLAY/PAUSE:** To play/pause the track being played in DVD mode or show the favorite list in TV mode.
- 12. STOP:** To stop DVD playback.
- 13. TEXT:** To switch on/off teletext in TV mode and skip to previous track in DVD mode.
- 14. HOLD:** Hold on or off for current page display in TELETEXT mode and skip to next track in DVD mode.
- 15. INDEX:** To display the index page in Teletext mode and fast backward playing in DVD mode.
- 16. SIZE:** To change the display size in teletext mode or fast forward playing in DVD mode.
- 17. D.MENU:** To display DVD-disc menu.
- 18. TITLE:** To display DVD title menu.
- 19. PROG:** To enter program setting in DVD mode, display red subject in Teletext mode and select DVB program in DVB mode.
- 20. INTRO:** To INTRO play (play the first 10 seconds of each track) when playing CD discs and display green subject in Teletext
- 21. REPEAT:** To repeat play in DVD mode and display yellow subject in Teletext mode.
- 22. A-B:** To repeat A-B playback or display blue subject in Teletext mode.
- 23. D.DISP:** To display track information in DVD mode.
- 24. GOTO:** To find a play point in DVD mode.
- 25. REVEAL:** To reveal or hide the words in Teletext mode and select angle in DVD mode (Angle function depends on DVD discs).
- 26. SUBPAGE:** To access sub-coded page in Teletext mode and zoom function of DVD playback.
- 27. LANG:** To select a program's language in DVB mode and DVD mode (where available).
- 28. SUBTITLE:** To switch the dialogue at the bottom of the screen.
- 29. I:** Slow motion playback in DVD mode.
- 30. EPG:** To show the Electronic Program Guide menu.
- 31. S.MODE:** To select different sound mode.
- 32. SLEEP:** To set the unit to standby automatically after a set period of time.
- 33. EXIT:** To display the setup menu in DVD mode or exit the current mode.
- 34. CH+/-:** To change channels up or down.
- 35. NICAM:** To turn on/off Nicam in TV mode.
- 36. CYCLE:** Switch between the current channel being viewed and the last channel viewed in TV mode.
- 37. EJECT:** To eject/load the disc in DVD mode.
- 38. MUTE:** To turn the sound on and off.

(2) Remote control battery installation and cautions

Replace battery by following the below steps:

Requires two AAA batteries.

1. Open the battery cover as shown below:



2. Install the battery into the battery tray.

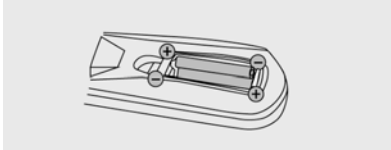

3. Close the battery cover

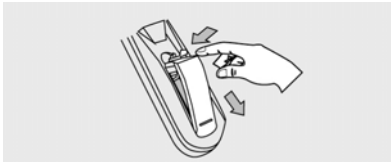

Caution:

1. Keep batteries out of children's reach.
2. Don't attempt to recharge, short-circuit, disassemble, heat or throw the batteries into the fire.
3. Always replace both batteries at the same time. Never mix new and old batteries or batteries of a different type.
4. If you don't intend to use the remote control for an extended period, remove the batteries to prevent possible leakage and corrosion.

Notes:

1. Do not drop, apply shock or step on the remote control.
2. Do not spill water on the remote control.
3. Do not use the remote control for other equipment at the same time.
4. If the TV does not operate when operating the remote control from a close range, you need to replace the batteries.
See above for directions on replacing batteries.

III. Installation and Connection

Connect the LCD TV/monitor

1. Connect the TV RF source to the ANTENNA port. TV RF signal including: Receiving antenna/satellite TV/CATV net. You can use 75Ω coaxial cable to connect the outdoor antenna.

Outdoor Antenna Connection:

Use 75Ω coaxial cable plug or 300-75Ω impedance converter to plug in antenna input terminal on the rear of the cabinet.

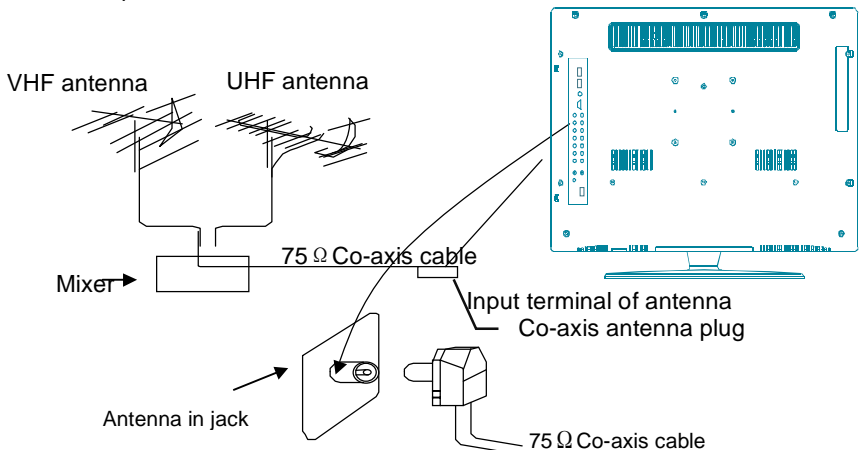

2. Connect the audio sources (Including DVD, VCD, etc.) to the proper AUDIO input jacks 'L' and 'R'.
3. Connect the video source to the VIDEO input jack by RCA cable.

4. Connect the video source to the S-VIDEO input jack of the TV by the S-video cable
5. When using the LCD as a computer screen, connect the PC from the VGA jack of the monitor by the relevant cable.

IV. TV/Monitor Screen Operation

(1) Basic operation

1. Press the **STANDBY** button on the unit or on the remote control to switch on the TV. The power indicator will light up in blue colour. Press the **STANDBY** button again to switch to standby mode, the indicator will change to red.
2. Press the **VOL -** or **VOL +** button to adjust the volume level. Press the **VOL -** button repeatedly to decrease the volume; press the **VOL +** button repeatedly to increase the volume from 0 to 100.

(2) Changing Channels

1. Press the **SOURCE** button on the remote control to select the **ATV** or **DTV** input mode. If you are using the receiver for the first time, an Installation Guide menu will be displayed to guide you through the channel scan, Use the remote control to finish channel scan (you can also refer to Chapter V in this manual for the channel scan operation).



2. Channel '1' will appear on the left top corner of the screen after the channel scanning is finished. Press the **CH-** or **CH+** button to select the previous or next channels or press the **0-9** buttons to enter a channel number directly.
3. Press the button on the remote control to switch between the

present channel to the last channel was viewed.

4. Press the **P.MODE** button repeatedly to cycle through the available video picture modes from the below different types

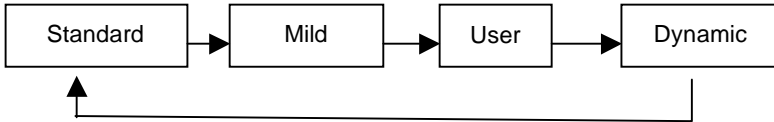

5. Press the **S.MODE** button repeatedly to cycle through the available sound modes from the below different types

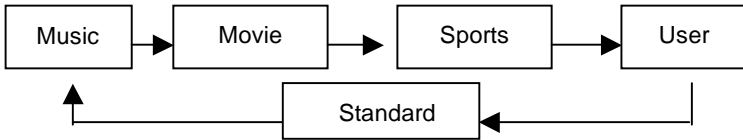

6. Press the **MUTE** button to cut off the sound output, press this button again to resume sound output.
7. Press the **DISPLAY** button to display the preset channel information.

(3) View different input signal sources

Press the **SOURCE** button then press the **▲** or **▼** button to select the available input sources as follow:

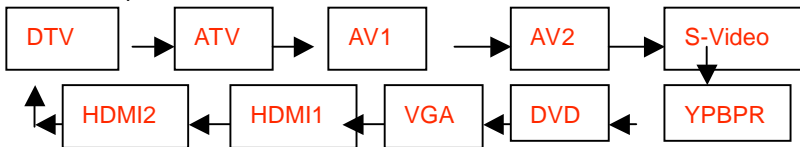

(4) View the TELETEXT program

1. Press the **SOURCE** button to select the DTV mode. Then press the **CH-** or **CH+** button on the remote control to select a DTV channel in order to pick up the TELETEXT signal, if broadcast.
2. Press the **TEXT** button to enter TELETEXT mode, press the **TEXT** button again to exit.
3. Press the **CH-** or **CH+** button to select the previous page or press the 0-9 numeric buttons for the next page.
Note: The first number should not be '0' or '9'.
4. Refer to the chapter of 'Remote Control' to understand other functions of

the TELETEXT buttons.

V. TV Channel Menu and Adjustment

CHANNEL menu

- Press **SOURCE** button to select DTV or TV input.
- Press **LCD MENU** button and the CHANNEL menu will appear.



- Press **▲▼** to select the items: Auto Tuning, DTV Manual Tuning, ATV Manual Tuning, **Program Edit**. Press **ENTER** button to confirm.
- Press the **LCD MENU** button to return to previous menu.
- Press the **EXIT** button to exit the menu.

Auto tuning



DTV Manual tuning

Press ◀▶ to select the channel, then press **ENTER** to start scan.



ATV manual tuning

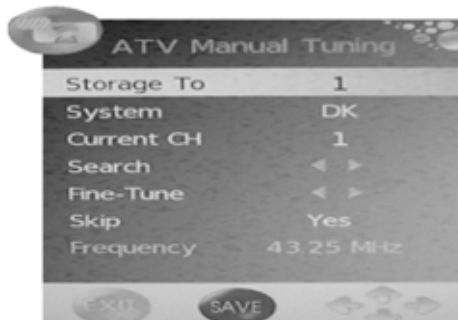

- Press the ▲ or ▼ button to select the items, and press the ► or ◀ button to adjust. See details in the following sub-options.
- Press the **ENTER** button to confirm and press the **LCD MENU** button to return to previous menu or press the **EXIT** button to exit.

Storage To

Press the ► or ◀ button to select the channel number you want to save to.

System

Press the ► or ◀ button to select the TV sound system.

Current CH

Press the ► or ◀ button to select the current channel.

Search

Press the ► or ◀ button to search forward/backward, press the **LCD MENU** or **EXIT** to stop the program searching.

Fine-Tune

Press the ► or ◀ button to fine tuning when the signal level of the current channel is weak.

Skip

Press the ► or ◀ button to turn on/off the switch of skip. When it's set to ON, the current channel will be skipped when you switch channels by pressing the **CH+** or **CH-** buttons.

Program Edit

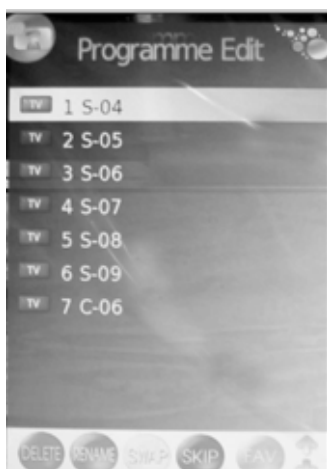

- Press the ▲ or ▼ button to select the channel.

Delete

Press **red** button, DELETE mark will be shown on the current channel; Press **red** button again, the current program will be deleted.

Rename

Press **green** button, RENAME mark will be shown on the current channel; then move cursor by ► or ◀ button, select characters by ▲ or ▼ button, at last press LCD MENU button to confirm this operation and return to previous menu.

Swap



Press **right** or **left** button firstly to move cursor to selected current program channel 1. And press **yellow** button to confirm, SWAP mark will be shown on the current channel

Then press **right** or **left** button firstly to move cursor to target program channel 2. SWAP mark will be shown also. And press **yellow** button to confirm.

Skip

Press **blue** button, SKIP mark will be shown on the current channel, it means the current program will be skipped and could not be searched ; Press **blue** button again, the mark SKIP will disappear, it means you cancel skip program selection.

FAV

Press **FAV** button, a mark  will display on the current item, it means you have selected favorite program ; Press **FAV** button again, the mark  will disappear, it means you cancel current favorite program selection.

PICTURE menu

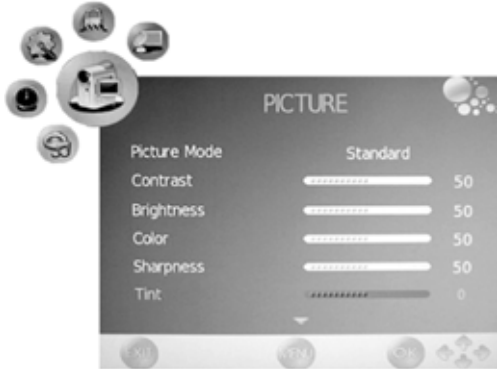

- Press the **LCD MENU** button to display the OSD menu ,then press the ◀ or ▶ button to select PICTURE menu.
- Press the ▲ or ▼ button to select the items in PICTURE menu, press the ▶ button to enter the sub-menu, press the **LCD MENU** button to return to the previous menu or press the **EXIT** button to exit.

Picture Mode

Press the ◀ or ▶ button to select picture modes.

Contrast

Press the ◀ or ▶ button to adjust the contrast.

Brightness

Press the ◀ or ▶ button to adjust the brightness.

Colour

Press the ◀ or ▶ button to adjust the colour.

Sharpness

Press the ◀ or ▶ button to adjust the sharpness.

Tint

Press the ◀ or ▶ button to adjust the sharpness, this option only works in VGA mode and VGA input connected.

Colour Temperature

Press the ◀ or▶ button to select colour temperature: Cool, User, Warm, **Standard.**

Red

Press the ◀ or ▶ button to adjust

Green

Press the ◀ or ▶ button to adjust

Blue

Press the ◀ or ▶ button to adjust

Aspect Ratio

Press the ◀ or ▶ button to select Aspect Ratio: Zoom1, Zoom2, Auto, 4:3, 16:9.

Noise Reduction

Press the ◀ or ▶ button to turn the Noise Reduction function on or off.

SOUND menu

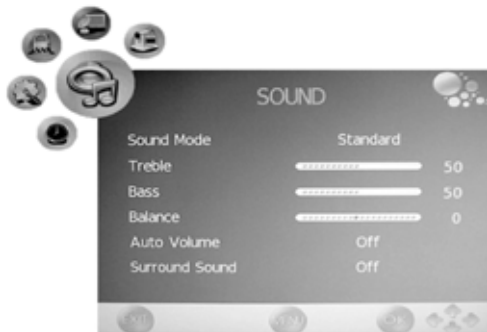

- Press the **LCD MENU** button to display the OSD menu ,then press the ◀ or ▶ button to select **SOUND** menu.
- Press the ▲ or ▼ button to select the items in **SOUND** menu, press the ◀ or ▶ button to enter the sub-menu, press the **LCD MENU** button to return to the previous menu or press the **EXIT** button to exit.

Sound Mode

Press the ◀ or ▶ to select sound mode: User, Standard, Music, Movie, Sports.

Treble

Press the ◀ or ▶ button to adjust the treble.

Bass

Press the ◀ or ▶ button to adjust the bass.

Balance

Press the ◀ or ▶ button to adjust the balance of left/right output channels.

Auto Volume

Press the ◀ or ▶ button to select off or on, when it's set to on, the volume level will be reduced automatically if you set the volume too high.

Surround Sound

Press the ◀ or ▶ button to turn the surround sound effect on or off.

TIME menu



- Press the **LCD MENU** button to display the OSD menu, then press the ◀ or ▶ button to select TIME menu.
- Press the ▲ or ▼ button to select the items in TIME menu, press the ◀ or ▶ button to enter the sub-menu, press the **LCD MENU** button to return to the previous menu or press the **EXIT** button to exit.

Clock

Press the ◀ or ▶ button to select hour and minute, press the ▲ or ▼ button to set the current time.

Off time

Press the ◀ or ▶ button to select on, press the ▶ button to enter the setup sub-menu, then to set the time you want the unit to be turned off, select the time using the ▲, ▼, ◀ or ▶ buttons.

On time

Press the ◀ or ▶ button to select on, press the ▶ button to enter the setup sub-menu, then to set the time you want the unit to be turned on, select the time using the ▲, ▼, ◀ or ▶ buttons.

Sleep timer

Press the ◀ or ▶ button to set the sleep time: 240min, 180min, 120min, 90min, 60min, 30min, 20min, 10min.

Auto sleep

Press the ◀ or ▶ button to select on or off. When it's set to on, the unit will turn to standby mode automatically if there is no signal input for a period of about 5 minutes.

Time Zone

Press the ◀ or ▶ button to set the time zone.

OPTION menu



- Press the **LCD MENU** button to display the OSD menu , then press the ◀ or ▶ button to select **OPTION** menu.
- Press the ▲ or ▼ button to select the items in **OPTION** menu, press the ◀ or ▶ button to enter the sub-menu, press the **LCD MENU** button to return to the previous menu or press the **EXIT** button to exit.

Language

Press the ◀ or ▶ button to select the OSD language, the default language is English.

Audio Language

Press the ◀ or ▶ button to select the Audio language, the default language is English.

Subtitle Language

Press the ◀ or ▶ button to select the Subtitle language, the default language is English.

Country

To show the country you have set when you started auto scan.

Restore Setting

Press the ▶ button to restore, this operation will reset the unit to factory default and all previous settings will be cleared.

LOCK menu



- Press the **LCD MENU** button to display the OSD menu ,then press the ◀ or ▶ button to select LOCK menu.
- Press the ▼ button and enter password, the default password is "0000".
- Press the ▲ or ▼ button to select the items in LOCK menu, press the ◀ or ▶ button to enter the sub-menu, press the **LCD MENU** button to return to the previous menu or press the **EXIT** button to exit.

Lock Channel

Press the ◀ or ▶ button to turn off or on.

Change Password

Press the **ENTER** or ► button and enter the new password.

Block Program

Press the **ENTER** or ► button to enter the program list. Press the ▲ or ▼ button to select the channel you want to lock then press the green button to lock, the lock icon will appear behind the locked channel, to un-lock the channel, select the locked channel and press the green button again, the lock icon will disappear.

Parental Guidance

Press the ◀ or ► button to set program rating to block some of programs.

Hotel Mode

Press the **ENTER** or ► button to enter the hotel mode list. Press the ▲ or ▼ button to select the related item, and set by ◀ or ► button

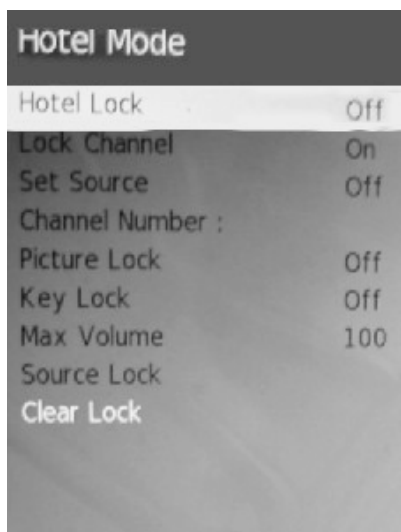

EPG menu

The EPG (Electronic Programme Guide) menu is used to look at what is being broadcast on a DTV or Radio channel at a later point in time. Press the EPG button to access the EPG menu, the detailed program information of the channel currently being viewed will be displayed.

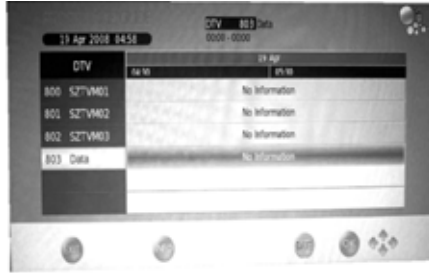

To see what is going to be broadcast after the current programme, press the ► button to change the time and press the ◀ button to move the time back. To view a different channel, press the ▲ or ▼ button. To book a wanted program for later watching, press the blue button to enter setting menu, then press ENTER button to confirm. Press the green button to enter the schedule list. To exit the EPG menu and watch the selected channel, press the **EPG** or **EXIT** button.

VI. DVD PLAYER OPERATION

a. Basic operation

1. Press the **SOURCE** button on the remote control to select the DVD function mode. Insert a disc into the slot of the DVD player and it will start to read the disc automatically.
2. Press the ▲ button on the remote control, the disc will automatically eject.

Note: Insert the disc with reflective data side facing to the front of the TV. Some slight picture and sound noise are produced when the disc is loading, unloading and during playback. This is normal and can be ignored.

HOW TO SELECT THE TRACK

If you want to play the second track or chapter, press the number button “2” directly. Then press the **ENTER** button to play.

HOW TO PAUSE PLAYBACK (STILL PLAYBACK)

Press the **PLAY/PAUSE** button once during playback.
Press the **PLAY/PAUSE** button again to resume normal playback.

HOW TO REMOVE THE DISC



Press the  button on the remote control.

Wait until the disc is completely ejected before removing.

HOW TO STOP PLAYBACK

Press the **STOP** button once, the DVD video player will stop. Then press the **PLAY** button to resume playback of the disc from the same point. Press the **STOP** button twice, and disc will stop completely. Press the **PLAY** button to start the DVD playback from the first track.

FAST FORWARD/ BACKWARD



Press the  or  buttons to toggle between different playback speeds in sequence at x2, x4, x8 or x20. Press the  button to return playing at normal speed.

Note: The sound is not available while playing in this mode.

SKIP TO NEXT/ PREVIOUS TRACK

Press the  or  buttons to select the next track or previous track.

b. Slow Play

Press the **SLOW/STEP** () button when playing, the disc will play at 1/2, 1/3, 1/4, 1/5, 1/6, 1/7 of the normal speed. Press the  button to return playing at normal speed.

Note: The sound is not available while playing in this mode.

c. Zoom Picture

This DVD video player allows you to zoom in/out of a picture as well as shift the zoom point. Press the **ZOOM** button during normal play or when in slow motion. The DVD player magnifies the center of the picture at 2x, 3x, 4x, 1/2, 1/3, 1/4 of the normal picture.

d. Repeat Play

You can use the **REPEAT** button to repeat the play of various sections of

your DVD.

Press the **REPEAT** button once to repeat playing the present chapter.

Press the **REPEAT** button again to repeat playing the present title.

Press the **REPEAT** button third time to repeat playing the whole disc.

Press the **REPEAT** button for the fourth time to cancel repeat play and return to normal play.

Note: For different discs, the REPEAT button may have a different function.

REPEAT A to B SPECIFIC SECTION

You can repeat a specific section by the **A-B** button on the remote control.

Firstly press the **A-B** button at the beginning of the section you want, then press it again at the end of the section. The unit will now repeat playing from A to B. If you want to cancel the repeat section, please press the **A-B** button once again.

Note: Some discs will not respond to the A-B repeat function.

e. Mute

Press the **MUTE** button on the remote control to suppress the sound output while a disc is playing. Press the same button again to resume playing with sound.

f. Menu playback

Press the **D.MENU** button to display disc menu or return to the root menu when playing the DVD discs.

Note:

For different DVD discs, the **D.MENU** button may have different menu display information.

g. Title playback

Press the **TITLE** button when playing the DVD discs, there will be an indication "**TITLE**" on the screen.

Press the **▲**, **▼**, **◀** or **▶** buttons to select your favorite title and press the **ENTER** button to play from the first chapter of selected title.

from the same point.

- If you press the **STOP** button twice the program playing will be cancelled.

j. Selecting the Camera Angles Setting

This DVD video player allows you to select from several different angles.

Press the **ANGLE** button while playing back a scene recorded with multiple angles. You may only press the **ANGLE** button when the angle icon appears on the DVD display. Each time you press the **ANGLE** button, the angle will change.

Notes:

- The angle function will not work on DVD video discs that do not contain recorded multiple angles.
- During still playback, you are able to change the camera angle. However, when you resume to normal playback, the camera angle changes to the new settings.
- The angle icon indicator will illuminate while playing back a title that contains at least one scene recorded with multiple angles.

k. Selecting Subtitles

This DVD video player allows you to display subtitles which are included on the disc.

By Pressing the **SUBTITLE** button during playback, you have the option to select a preferred subtitle from those included on the DVD video disc. To turn off the subtitle function, press the **SUBTITLE** button during playback until the subtitles disappears.

Notes:

- With some DVD discs, you may not be able to turn off the subtitles and they will appear on screen automatically.
- As you press the **SUBTITLE** button, the subtitles may not appear immediately during some screens.

l. Selecting languages

This DVD video player allows you to select a preferred languages which are

included on the Multi-languages DVD discs.

By Pressing the **LANG** button once during playback to display current language, press the **LANG** button again to toggle between different language mode in sequence.

Note: For MP3/CD discs playback, press the LANG button to switch between different audio channels in sequence.

m. MP3/JPEG playback

1. In DVD mode, Insert a MP3 or JPEG CD into the disc slot, the DVD video player will initialize the disc and the directory (folder) will be shown on screen. The first MP3 or JPEG file will be played automatically.



2. Press the **▲**, **▼**, **◀** or **▶** buttons to select the folders, MP3/JPEG files or modes and press the **ENTER** button on the remote control to enter the folder or start playback.
3. When playing MP3 files, press the **▶▶** or **◀◀** buttons during playback to skip the tracks.

Notes:

- When playing MP3 Files, there is no picture display ,only there is audio output.
- When viewing the JPEG pictures, you could press the **▲**, **▼**, **◀** or **▶** buttons to flip or rotate the picture.
- When viewing the JPEG pictures, you could press D.MENU button to enter into preview mode to display 12 pictures. Press **▶▶** or **◀◀** button to select next or last page or press the numeric buttons to view the corresponding pictures.

n. INTRO playback

Press the **INTRO** button to play the first 10 seconds of each track when playing CD discs .

o. Customizing the Function Settings

This DVD video player allows you to customise the performance to your personal preference.

DISPLAYING THE SETUP MENU SCREEN:

The DVD SETUP MENU screen asks you to select a setting category from SYSTEM SETUP, LANGUAGE SETUP, AUDIO SETUP, VIDEO SETUP, SPEAKER SETUP and DIGITAL SETUP. The selected category will provide you with the setting details on the TV screen. Please look at the following for more details.

Press the **DVD SETUP** button to enter the SETUP MENU. Press the **▲, ▼, ◀** or **▶** buttons to select and highlight the category. Then press the **ENTER** button to confirm. Press the **DVD SETUP** button again to return to the root menu or to exit the setting menu.

Note: Functions and menu may change without notice.

1. System Setup

TV SYSTEM

This menu enables you to set the picture format for your TV/DVD between NTSC/ PAL/ AUTO according to your request and local TV system.

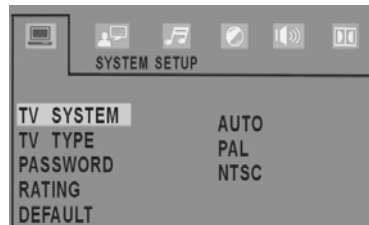

TV TYPE

This menu enables you to select one of the three aspect ratios:

4:3 PS / 4:3LB / 16:9

● **4:3PS(Normal)**

Normal Pan and Scan is used for most normal television broadcasts. It has an aspect ratio of 4:3. Choose this setting when viewing the movies, the picture will fill the screen but

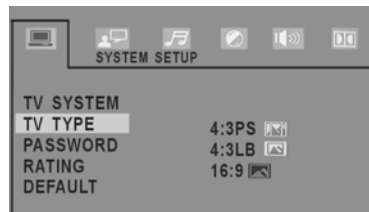

left and right edges of the picture may be cut off from the screen.

- **4:3LB(Normal)**

Choose this setting will allow you to view the movies in its original aspect ratio. the entire frame of the movie will be displayed on screen but will occupy a smaller portion of the screen.



- **16:9 (Wide)**

Choose this setting if you have a widescreen television, this setting will allow the original aspect ratio to be displayed.



Note:

- Playback screen size may be varied according to the disc contents.
- For discs with 4:3 contents, using any mode would only display 4:3 screen
- Screen ratio selection should be according to the connected TV or display aspect ratio.

PASSWORD

This is used to lock and unlock

The RATING setting. The default setting is locked. Enter the default password "0000" by numeric buttons,

then press **ENTER** button to unlock. To change the password just input 4 digits you want in unlock mode.

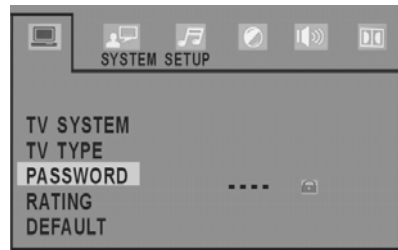

RATING

You could set the rating options according to your preference.

The rating restriction divided in eight different category from KID SAFE to ADULT. The default setting is ADULT.

Note: please refer to PASSWORD to lock/unlock the rating setting.

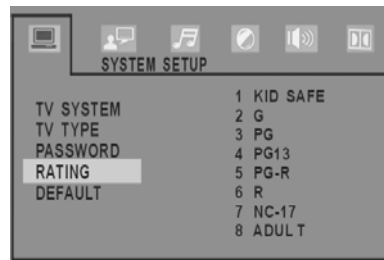

DEFAULT SETTING

Press the **ENTER** button to restore factory default.

Note: The Password and Rating setting can not be restored.

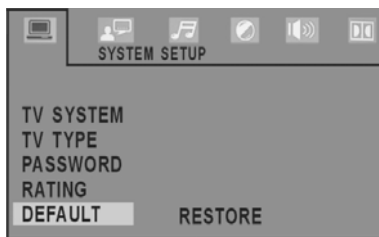

2. Language Setup

Press the **▲**, **▼**, **◀** or **▶** buttons to select the LANGUAGE setup icon, press **ENTER** button to confirm.

You could choose the available languages as displayed on the screen menu.

Note: Audio languages, Subtitle languages and Menu languages are DVD discs specified.

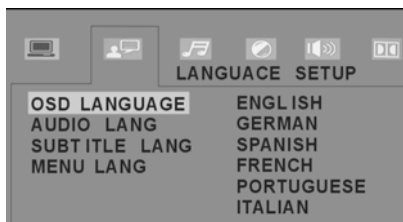

3. Audio Setup

AUDIO OUTPUT

Press the **▲**, **▼**, **◀** or **▶** buttons to select the AUDIO OUT setup icon, press **ENTER** button to confirm.



SPDIF/OFF: No output is sent to the coaxial output. Use this option if you have not connected the coaxial output to any decoder or amplifier.

SPDIF/RAW: When selected, the raw audio contained on the disc is passed directly to the Coaxial output. Use this setting when connecting the coaxial output to a multi-channel decoder/ amplifier.

(REMARK: Please note that SPDIF/RAW output is not available on this model)

SPDIF/PCM: When selected, the audio contained on the disc is passed directly to the Coaxial output in PCM format. This format ensures a very high quality but it does not support the

surround sound effect. Use this setting when connecting the coaxial output to a receiver-amplifier not capable of decoding multi-channel audio.

KEY

Press the ▲, ▼, ◀ or ▶ buttons to adjust the key setting.

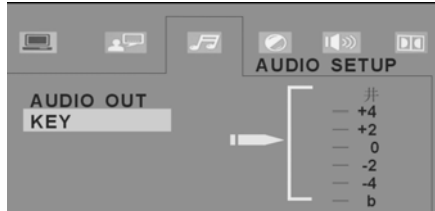

4. Video Setup

Press the ▲, ▼, ◀ or ▶ buttons to Move the cursor. Press **ENTER** button to confirm. You could choose the available range as displayed on the screen menu.

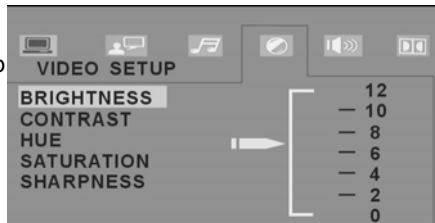

5. Speaker Setup

DOWNMIX

Press the ▲, ▼, ◀ or ▶ buttons to select available one displayed on the menu.



FRONT

Press the ▲, ▼, ◀ or ▶ buttons to select available speaker volume; LARGE or SMALL

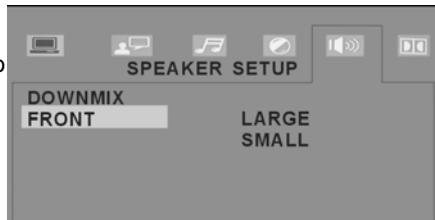

6. Digital Setup

DYNAMIC RANGE

Press the ▲, ▼, ◀ or ▶ buttons to adjust the compression ratio for different audio effect, When

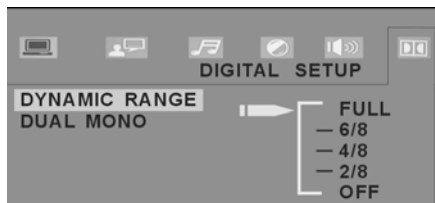

selected FULL, the peak signal value is smallest; When selected OFF, the peak signal value is biggest.

DUAL MONO

Press the ▲, ▼, ◀ or ▶ buttons to select 4 different audio output modes: STEREO / MONO L / MONO R / MIX MONO.



VII. Other Operation

PC audio in operation

This unit has a PC audio input jack. Connect the unit to your PC with the correct audio cable (not included). Ensure the unit is in PC mode and adjust the volume.

Trouble Shooting

Should the unit not function, please check the following table to find out the possible problem. If you still can not solve the problem, please contact the Grundig Warranty line.

a. DVD player

SYMPTOM	CAUSE	POSSIBLE CURE
No sound	Wrong connection or loose connection; System mute.	Check and correct all connections; Cancel mute.
Disc playing abnormally	Disc dirty or scratched	Clean or change the disc.
Disc not playing	Disc placed upside down	Turn the disc the correct side up.
Remote control not working	Obstacles between remote control and the sensor on the unit; Battery has no power; Too far from the TV.	Clear away obstacles; Change battery; Operate at a closer distance.
Does not work	External interference with the CPU.	Pull out the plug and insert again.

b. TV/Monitor

Symptom	Remedy
No power	<ol style="list-style-type: none"> 1. Check whether the power plug is connected to the power supply. 2. Pull out the plug and wait for 60 seconds, and then insert the power plug again and switch on the TV/monitor.
No picture	<ol style="list-style-type: none"> 1. Check whether the antenna is connected properly. 2. Change to another channel. 3. Change the length and the contrast setting. 4. Make sure that the AV picture input cable is connected properly.
No sound	<ol style="list-style-type: none"> 1. Increase the volume. 2. Check whether the TV is in MUTE mode. 3. Make sure that the sound system setting is correct. 4. Ensure the AV audio signal input cable is connected properly.
Color distortion	<ol style="list-style-type: none"> 1. Ensure that the equipment is connected properly. 2. Ensure that the AV video signal input is connected properly.
Picture/sound have interference	<ol style="list-style-type: none"> 1. Check whether the equipment is connected properly. 2. Adjust the antenna if use an outdoor antenna.
Remote control is not functioning	<ol style="list-style-type: none"> 1. Make sure that the batteries are installed with correct polarities. 2. Clean the remote sensor. 3. Ensure that there is no foreign object between the remote control and the sensor. 4. Operate the remote control at a distance no more than 6 metres from the remote sensor
Screen glittering under PC mode	Reset the computer and enter into the safety mode, then select the appropriate screen type by consulting the operation manual.
Screen traversed under PC mode	The phase is not appropriate. Enter into the PC setting and change to correct level.

VIII. Notes

- (1) Please read these operating instructions carefully before you operate this unit.
- (2) When you want to cut off the electricity supply to the unit, please press the **STANDBY** button on the unit, then take out the plug from the wall outlet.
- (3) Don't press any buttons if you are not using the unit. Set the **STANDBY** button to "OFF", and take out the batteries from the remote control if the unit is not being used for a long period of time.
- (4) Be cautious of the safe mark. 
- (5) Repairs are to be referred to qualified service personnel. DO NOT attempt to take apart by yourself.
- (6) Due to a sudden change in temperature or humidity, or when warm air comes into contact with any cold parts in the unit, condensation may form. When condensation forms inside, the unit may not function well. Once condensation disappears, the unit will return to normal functions. Placing the unit in a warm room will help to dry up condensation. This should take 1 to 2 hours, depending on environmental conditions. As condensation may also appear on the disc, it should be wiped from the center towards the outer side using a dry cloth.
- (7) It is dangerous to use warped or broken discs since lasers rotate at high speed. Never use discs repaired with plastic tape or glue, as it will lead to damage. After playing, if you hear a strange noise or the unit flatters, e.g. the disc does not turn smoothly, please stop playing immediately.
- (8) Please remove the disc after use and put into a case, store them in a vertical position. Tilting or piling may lead to warping. Please keep the discs away from direct sunlight, high temperature and humidity.
Do not stick labels onto discs.
Do not scratch the surface of discs.

IX. Maintenance

1). Cleaning the cabinet

Use a soft cloth slightly moist with a mild detergent solution. Do not use a solution containing alcohol, spirits, ammonia or abrasives.

2). Cleaning discs

When a disc becomes dirty, clean it with a cleaning cloth. Wipe the disc from the centre outwards.

Do not use solvents such as benzene, thinners, commercially available cleaners or antistatic spray intended for analogue records.

WARNING:

To prevent fire or shock hazard, do not expose this unit to rain or moisture. Do not remove cover, no user serviceable parts inside, refer servicing to qualified service personnel.



X. Specifications

Model No.		GLCD3206HDV/GLCD3206HDVW/ GLCD3206HDVS
LCD	Screen size	32 inch
	Screen format	16:9
	Resolution	1366*768
	Contrast	1000:1
	Brightness	500 cd/m ²
	Display colours	16.7M
	View angle	176° (horizontal) / 176° (vertical)
	Response time	5 ms
TV	TV system	Digital: DVB-T/ Analog: PAL I/BG/L/DK
	DTV decode	Audio: MPEG2 Audio Layer I&II Video: MPEG2 Transport MP@HL
	DTV de-mod.	Demodulator : COFDM OFDM Mod.: 2K, 8K FFT, SFN and MFN Packed Carriers: 2K/8K Guard Interval: 1/4, 1/8, 1/16, 1/32
	Tuner	Integrated and frequency synthesis
DVD	Compatible with CD/MP3/WMA/JPEG/VCD/DVD formats	
Terminal s	PC VGA	X 1
	PC AUDIO	X 1
	HDMI	X 2
	YPbPr	X 1
	YPbPr audio in L/R	X 1
	AV output	X 1
	AV input 1	X 1
	AV input 2	X 1
	S-VIDEO input	X 1
	Coaxial	X 1
	RF antenna	X 1
Audio output	2*8W	
Gross weight	16 Kgs	
Power supply	AC110~240V, 50Hz/60Hz	
Power Consumption	Max 200W	

- Design and specifications are subject to change without prior notice.

XI. Display modes

Resolution	Horizontal Freq. (KHz)	Vertical Freq. (Hz)
720x400	31.5	70
640x400	31.5	70
640x480(VGA)	31.5	60
640x480(VGA)	37.9	72
640x480(VGA)	37.5	75
800x600(SVGA)	37.9	60
800x600(SVGA)	47.2	72
800x600(SVGA)	46.9	75
1024x768(XGA)	48.4	60
1024x768(XGA)	56.5	70
1024x768(XGA)	60.0	75
1280x1024(SXGA)	63.5	60
1280x1024(SXGA)	80.0	75

1. Modes, which are not listed in the above table, may not be supported. For an optimal picture it is recommended to choose a mode listed in the table.
2. You have 13 available modes compatible with windows.
3. It can happen that the image is disrupted. This can occur as result of a signal from the VGA card, which does not correspond with the usual standard. This is not, however, an error. You can improve this situation by altering any automatic setting or by manually changing the phase setting and the pixel frequency menu.
4. If you switch off the TV/monitor, interference lines can occur on your screen. But it's not a problem, no need to concern about it.
5. To extend the service life of the product, we recommend that you use your computer's power management function.

Note: Design and specifications are subject to change without notice.

Warranty

Please keep your receipt as proof of purchase. This product is warranted for any defect in materials or workmanship for three years after the original date of purchase. This product is for normal domestic and office use only. This warranty does not cover damage from misuse or neglect, accidental damage, vermin infestation, excessive voltages such as lightning or power surges or any alternation that affects the performance or reliability of the product.

In the unlikely event that your product fails to work normally, please contact **Grundig Warranty on 1800 509 394 (Australia) or 0800 450 259 (New Zealand)** and have your receipt of purchase on hand.

This guarantee is subject to the following provisions:

- It is only valid within boundaries of the country of purchase;
- The product must be correctly assembled and operated in accordance with the instructions contained in the manual;
- This product must be used solely for domestic purposes;
- The guarantee does not cover accidental damage;
- The guarantee will be rendered invalid if the product is resold or has been damaged by inexperienced repair;
- The manufacturer disclaims any liability for incidental or consequential damaged.

This guarantee is in addition to, and does not diminish, your statutory or legal rights.

PO BOX 6287

Silverwater NSW 1811

www.grundig.net.au

Grundig Warranty: 1800 509 394 Australia

Grundig Warranty: 0800 450 259 New Zealand

PO BOX 6287
Silverwater NSW 1811
www.grundig.net.au

Ver. 2 13-August-2009