

Contents

Remote Control	2	Teletext	22
Control Panel Buttons and Rear Panel	3	To operate Teletext	22
Preparation	4	To select a page of Teletext	23
Features	4	To Select Index Page	23
Safety Precautions	4	To Select Teletext with a TV Programme	23
Before Switching on your TV	6	Searching for a page while watching TV	23
Power connection	6	To Select Double Height Text	23
Connections to the RF input socket	6	To Reveal "concealed" Information	23
How to connect other devices	6	To Stop Automatic Page Change	23
Inserting batteries in the remote control handset ..	6	To Select a Subcode Page	23
Switching the TV ON/OFF	6	Split Screen	23
To switch the TV on	6	To exit Teletext	23
To switch the TV off	6	To Display the Time	23
Initial Settings	7	Fastext	24
Basic Operations	8	Connect Peripheral Equipment	24
Operating with the buttons on the TV	8	Via the Scart	24
Operating with Remote Control	8	EXT2S Mode	24
Everyday Operation	8	Via Ant Input	24
Information Banner	8	Decoder	24
Electronic Programme Guide (EPG)	9	TV and Video Recorder	24
Displaying The Subtitles	9	Playback NTSC	24
Digital Teletext	10	Search for and store the test signal of the video recorder	25
Over Air Download	10	Camera and Camcorder	25
Widescreen	10	Connect the decoder to the video recorder	25
IDTV Menu System	10	Connecting Headphones	25
Channel List	10	Software Update Socket	25
Installation	12	Antenna Connections	26
Configuration	13	Tips	27
Timers	14	Care of the Screen	27
Language	15	Poor Picture	27
TV Setup	15	No Picture	27
Common Interface	15	Sound	27
Analogue TV Menu System	16	Remote Control	27
Sound Menu	16	No solution	27
Picture Menu	17	Bad picture (in digital mode)	27
Feature Menu	19	Specifications	27
Installation Menu	19	Important Instruction	28
Programme Menu	20		
Other Features	22		
TV Status	22		
Programme Swap (P<P)	22		
Double-digit (- -)	22		
Sound Indicator	22		
Zoom	22		
Mute Indicator	22		
Volume Bar	22		
AV Modes	22		

Remote Control

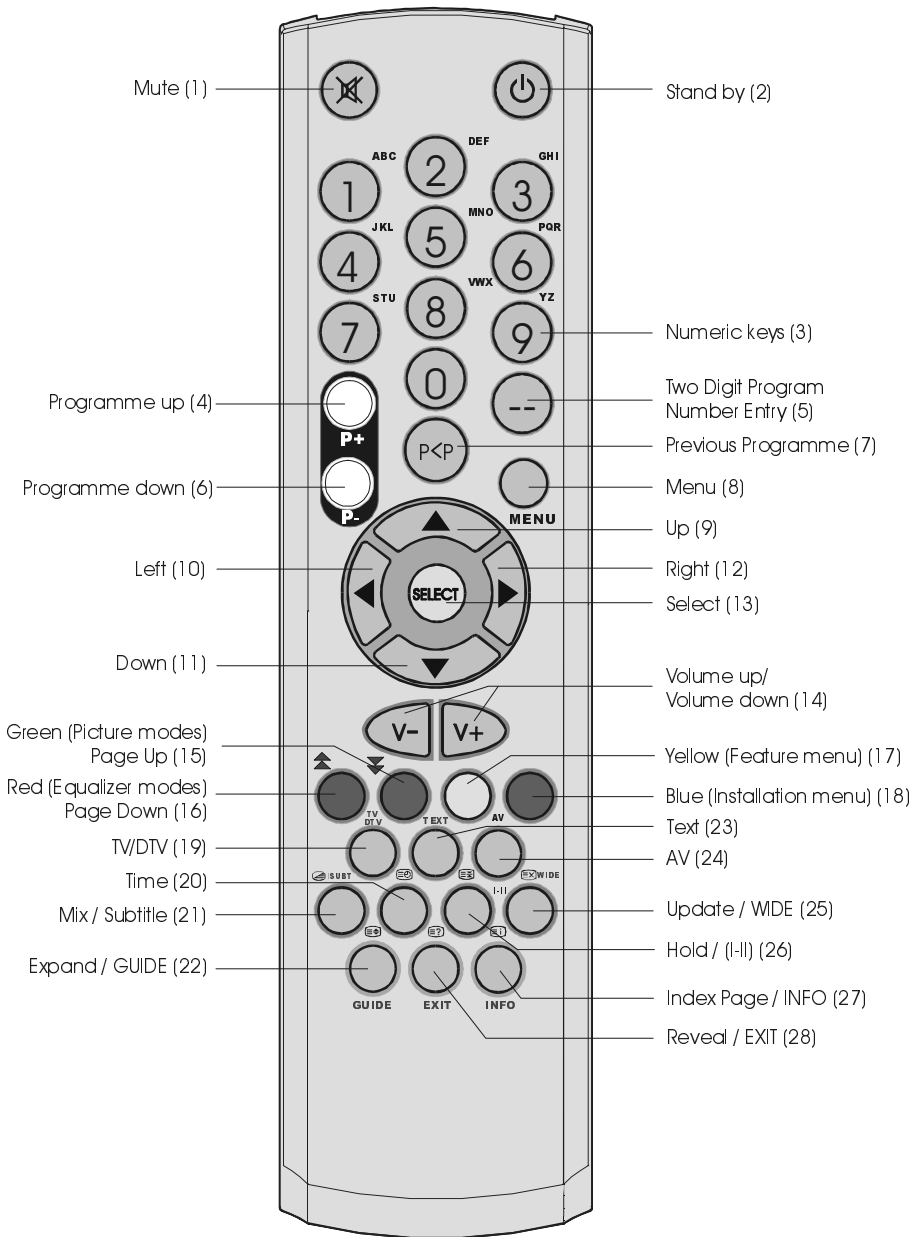

Control Panel Buttons and Rear Panel

FRONT PANEL

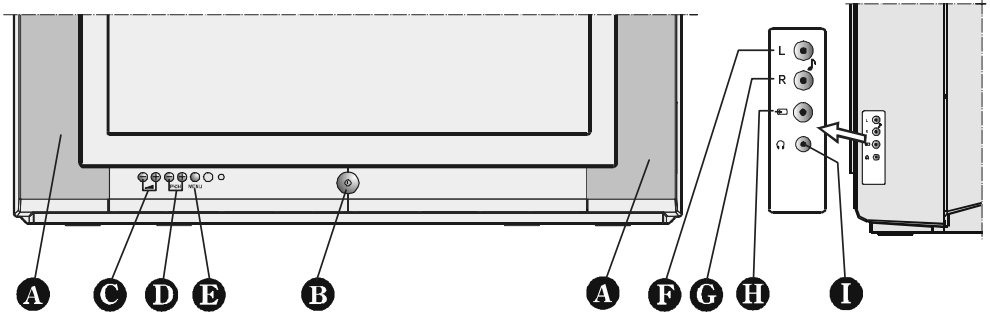

REAR PANEL

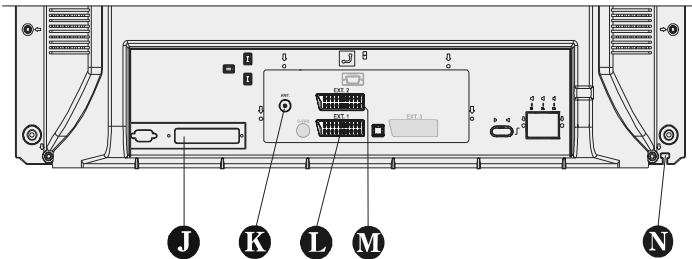

- | | |
|------------------------------------|--|
| A Speakers (left + right) | H VIDEO (↔)= VCR |
| B ⏻ = Power On / Off | I 🎧 = Headphone 3,6 mm Ø |
| C - ▲ + = Volume -/+ | J CI (Common Interface) Slot |
| D - P/Ch + = Program -/+ | K ANT = Antenna (75 Ω) |
| E MENU = Menu | L EXT.1 = Scart Socket 1 |
| F AUDIO L (🎧) = Audio left | M EXT.2 = Scart Socket 2 (with S-Video) |
| G AUDIO R (🎧) = Audio right | N Power Cable |

Preparation

For ventilation, leave a space of at least 10 cm free all around the set. To prevent any fault and unsafe situations, please do not place any objects on top of the set.

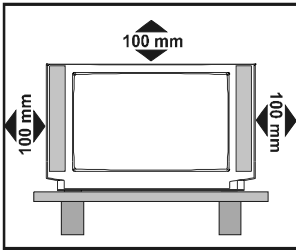

Use this apparatus in moderate climate.

Features

- It is a remote controlled colour television.
- Fully integrated Digital TV (DVB-T)
- 100 programmes from VHF, UHF bands or cable channels can be preset.
- It can tune cable channels.
- Controlling the TV is very easy by its menu driven system.
- It has two Scart sockets for external devices (such as computer, video, video games, audio set, etc.)
- Mono or Stereo sound systems (Virtual Surround) are available.
- Teletext (Fastext, Toptext).
- It is possible to connect headphone.
- A.P.S. (Automatic Programming System).
- All programmes can be named.
- Programme swapping between last watched two programmes.
- Forward or backward automatic tuning.
- Sleep timer.
- Child Lock.
- Automatic sound mute when no transmission.
- When no valid signal is detected, after 5 minutes the TV switches itself automatically to stand-by mode.
- WSS (Wide Screen Signaling).
- NTSC Playback.
- S-Video (via SCART)
- Front-AV in is available.
- Real Flat

Safety Precautions

1. Power Source

The receiver should be operated only from a **230-240V AC, 50 Hz.** outlet. Ensure you select the correct voltage setting for your convenience.

2. Power Cord

The power supply cord should be placed so that it is not likely to be walked on or pinched by items placed upon them or against it. Pay particular attention to cord where it enters the plug, power outlet, and the point where it exits from the receiver.

3. Moisture and Water

Do not use this equipment in a humid and damp place (avoid the bathroom, the sink in the kitchen, and near the washing machine). Do not expose this equipment to rain or water, as this may be dangerous and do not place objects filled with liquids on top. Avoid from dripping or splashing.

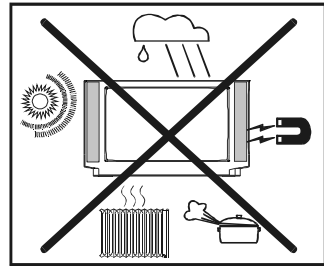

4. Cleaning

Before cleaning, unplug the TV from the main supply, outlet. Do not use liquid or aerosol cleaners. Use soft and dry cloth.

5. Ventilation

The slots and openings on the receiver are intended for ventilation and to ensure reliable operation. To prevent overheating, these openings must not be blocked or covered in anyway.

6. Lightning

In case of storm and lightning or when going on holiday, disconnect the power cord from the wall outlet.

7. Replacement Part

When replacement parts are required, be sure the service technician has used replacement parts which are specified by the manufacturer or have the same specifications as the originals. Unauthorised substitutions may result in fire, electrical shock, or other hazards.

8. Servicing

Please refer all servicing to qualified personnel. Do not remove cover as this may result in electric shock.

9. X-rays

The x-rays generated in this television are shielded sufficiently.

10. Naked Flame Sources

Do not place naked flame sources on the apparatus.

Warning!

Any intervention contrary to regulations, in particular, any modification of high voltage or a replacement of the picture tube may lead to an increased concentration of x-rays. Any television modified in this way no longer complies with license and must not be operated.

Instructions for waste disposal:

- Packaging and packaging aids are recyclable and should principally be recycled. Packaging materials, such as foil bag, must be kept away from children.
- Batteries, including those which are heavy metal-free, should not be disposed of with household waste. Please dispose of used batteries in an environmentally sound manner. Find out about the legal regulations which apply in your area.

**“DO NOT LEAVE YOUR TV AT
STAND-BY OR OPERATING WHEN
YOU LEAVE YOUR HOUSE”**

Cleaning The Screen

Your TV is fitted with a “True Flat” picture tube. The surface of the screen is covered with a foil. Under no circumstances may this be damaged.

To clean

Clean the laminated screen with a soft cotton cloth. Only non-alkaline, thinned soapsuds on a basis of water or alcohol be used to moisten the cloth. Rub the surface gently with the cloth until the surface is completely dry.

Under no circumstances...

may the screen be wiped with conventional glass cleaning fluid.

may the screen be brought into contact with abrasive materials.

may soiling be removed by polishing or scouring.

To clean off sticky substances, the cloth can be moistened with acetone.

Under no circumstances should acetone be used to clean the TV cabinet.

CAUTION

RISK OF ELECTRIC SHOCK



The lightning flash with arrowhead symbol, within an equilateral triangle, is intended to alert the user to the presence of uninsulated “dangerous voltage” within the product’s enclosure that may be of sufficient magnitude to constitute a risk of electric shock of persons.



The exclamation point within an equilateral triangle is intended to alert the user to the presence of important operating and maintenance (servicing) instructions in the literature accompanying the appliance.

Before Switching on your TV

Power connection

IMPORTANT: The TV set is designed to operate on **230-240V AC, 50 Hz**.

- After unpacking, allow the TV set to reach the ambient room temperature before you connect the set to the mains.

Connections to the RF input socket

- Connect the aerial or cable TV plug to the RF input socket located at the back of the TV and connect the cable plug coming out from the TV out socket located at the devices (VCR, DVB etc.) to this socket as well.

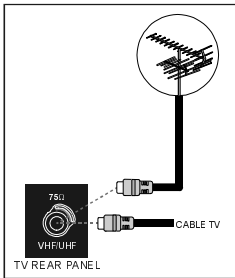

How to connect other devices

IMPORTANT: Switch off the TV before connecting any external device.

Sockets for external connections are at the back and front of the TV. For connection of other devices via Scart refer to the manuals of the related devices.

Inserting batteries in the remote control handset

- Place the batteries in the right directions as seen below.
- Remove the battery cover located on the back of the handset by gently pulling upwards from the indicated part.
- Insert two **AAA (R03)** or equivalent type batteries inside.
- Replace the battery cover.

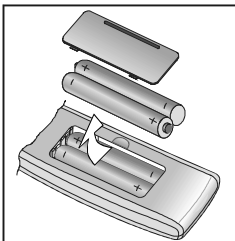

NOTE: Remove batteries from remote control handset when it is not to be used for a long period. Otherwise it can be damaged due to any leakage of batteries.

Switching the TV ON/OFF

To switch the TV on

Your TV will switch on in two steps:

- 1- Press the power button located on the front of the TV. Then the TV switches itself to standby mode and the **RED LED** located on the lower left side of the TV turns on.

- 2- To switch on the TV from stand-by mode either:

Press a digit button on the remote control so that a programme number is selected,

or,

Press Programme Up or Down buttons on the front of the TV or on the remote control, so that last switched off programme is selected.

By either ways the TV will switch on and the **RED LED** will turn **GREEN**.

To switch the TV off

- Press the stand-by button on the remote control, so the TV will switch to stand-by mode and the **GREEN LED** will become **RED**,

or,

Press the power button located on the front of the TV, so the TV will switch off and the **GREEN LED** will turn off.

SILENCE MODE:

When you turn your IDTV off by pressing Stand-by button (on RC), IDTV switches into SILENCE mode.

In the silence mode IDTV searches for a new software. If a new software is found, it is loaded onto the old s/w without any warning message.

You can terminate silence mode any time you want by pressing "O", "P+ / P-" or digit buttons.

Initial Settings

When the TV is turned on for the first time, it is in the digital mode.

Because this is the first time the TV is used, there are no channels stored in the memory and the following message appears on the screen.

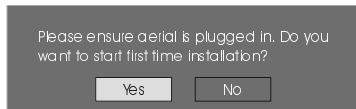

• To start installation process, select “Yes”, to cancel select “No”.

• To select an option “Yes or No”, highlight the item by using ◀ or ▶ buttons and press the “SELECT” button.

The IDTV will automatically tune to the UHF transmission channels 21 to 68 looking for digital terrestrial TV broadcasts and displaying the names of channels found. This process will take about five minutes. To cancel searching, you can press the “MENU” button at any time during the process.

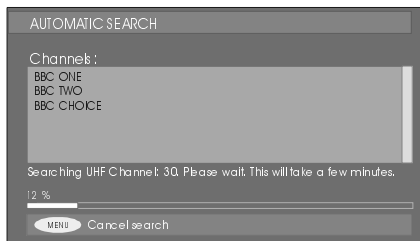

After **Automatic Search** process is completed, the following message asking for analogue channel search appears on the screen.

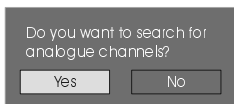

To search for analogue channels, select “Yes”. TV switches to the analogue TV mode and the menu below is displayed to search for analogue channels.

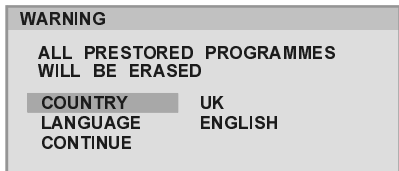

• First select your country by pressing ◀ or ▶ button. This will affect the sort process in APS.

• By pressing the ▲ or ▼ buttons, come to the Language item and select the language in which the menus of the TV will appear. You can see the available lan-

guages by pressing ◀ or ▶ button. As soon as you change the language, the menu items will be displayed in the selected language.

• To select “Continue” use ▲ or ▼ button. By pressing ◀ or ▶ button start the A.P.S.

• When you start A.P.S. the following window will appear on the screen.

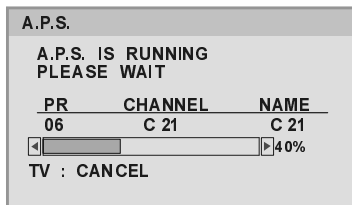

After **APS** is finalized, a programme list will appear on the screen. In the programme list you will see the programme numbers and names assigned to the programmes.

PROGRAM		PR 01			
01	C 12	11	----	21	----
02	C 23	12	----	22	----
03	C 45	13	----	23	----
04	C 47	14	----	24	----
05	C 50	15	----	25	----
06	C 55	16	----	26	----
07	----	17	----	27	----
08	----	18	----	28	----
09	----	19	----	29	----
10	----	20	----	30	----

NAME INSERT
 DELETE AUTOSTORE

If you do not accept the locations and / or the programme names of programmes, you can change them in Program menu. For details see Program menu on page 20.

To display channel list in IDTV, switch to the IDTV via pressing the “TV/DTV” button. Then press the “MENU” button to enter main menu, **Channel List** will be highlighted. Press the “SELECT” button to enter the menu. For detailed information see page 10.

Basic Operations

You can operate your TV using both the remote control handset and onset buttons.

Operating with the buttons on the TV

Volume setting and programme selection can be made using the buttons on the front of the TV.

Volume Setting

- Press “-” button to decrease volume or “+” button to increase volume, so a volume level scale (slider) will be displayed in the lower middle side of the screen.

Programme Selecting

- Press “P/CH+” button to select the next programme or “-P/CH” button to select the previous programme.

Entering MENU

- Press “MENU” button to enter the MENU. In the MENU select sub-menu using “-P/CH” or “P/CH+” button and enter the sub-menu using “-” or “+” button. To learn the usage of the menus, refer to the Menu System section.

Operating with Remote Control

The remote control handset of your TV is designed to control all the functions of the model you selected. The functions will be described in accordance with the menu system of your TV.

Functions of the menu system are described in Menu System section.

Volume Setting

Press “V+” button to increase volume. Press “V-” button to decrease volume. A volume level scale (slider) will be displayed on the screen.



Programme Selecting (Previous or next programme)

- Press “P-” button to select the previous programme.
- Press “P+” button to select the next programme.

Programme Selecting

Press digit buttons on the remote control handset to select programmes between 0 and 9. TV will switch to the selected programme. To select programmes between 10 - 99, you must use the double digit button “_ _”.

“_ _” is displayed on the upper left side of the screen.

After this, you can enter a programme by pressing two digit keys consecutively. If you have not pressed a key within 3 seconds, this function will be ignored and the display will be erased. Likewise, you must enter the second digit within 3 seconds of entering the first digit.

Programme Swapping

- Press “P<P” (programme swap) button to select the last selected programme. This button provides swapping between the last two programmes. For example, select programme 8, then select programme 2. Now, if you press “P<P” button, programme 8 will be selected. If you press the same button again, programme 2 will be selected and so on.

Everyday Operation

Pressing the “TV/DTV” button at any time while watching television programmes will switch the TV set between displaying the digital terrestrial television broadcasting and its normal analogue broadcasting.

Information Banner

Whenever you change channel, using the “P+” / “P-” button or the digit buttons, TV displays the channel picture along with an information banner at the bottom of the screen. This will remain on the screen for approximately three seconds. The information banner can also be displayed at any time while watching TV by pressing the “INFO” button on the remote control.

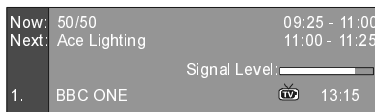

The information banner gives a number of facts on the channel selected and the programmes on it. The name of the channel is displayed, along with its channel list number and an indication of the strength of the signal received on this tuning channel.

Hint

Not all channels broadcast the programme data. If the name and times of the programme is not available then “No Information Available” is displayed in the information banner.

Icons are also displayed in the information banner and if this channel is a favourite channel:

Favourite channel icon .

If the selected channel is locked, you must enter the correct four digit code to view the channel.

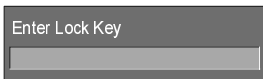

Electronic Programme Guide (EPG)

Some, but not all, channels send information about the current and next events. Please note that event information is updated automatically. If there is no event information data available in channels, only channel names with “No Information Available” banner is displayed.

- Press “GUIDE” button to view the EPG menu.
- In EPG Menu, you can easily see the extended help information by pressing “INFO” button and by pressing this button again you can close this window.



• In the EPG Menu all channels are displayed. Current channel is highlighted. Use ▲ or ▼ buttons to change channels. Also press ▲ or ▼ buttons to make page up/down scroll for the channels.

• If you highlight an event, short event description, extended event description, start and finish times of event are displayed on the screen.

• When the current programme is highlighted, the box is switched to the highlighted channel by pressing the “SELECT” button.

• If you press the “SELECT” button when a next event is highlighted, a reminder is set for the highlighted programme and a clock appears across the highlighted channel line.

Programme reminders can be set to signal that a programme is about to start when you are watching another channel. If you set reminder to a programme, then you will be asked for switching to that channel when the reminder time is reached.

- Press the “MENU” button to view the 7 day EPG.
- Press ▲ or ▼ button to navigate in Channels or Programmes.
- Press ◀ or ▶ button to navigate through the channel and programme list.



• With “RED/GREEN” buttons you can change schedule time. By pressing “YELLOW/BLUE” you can advance the schedule backward / forward of a day.

• If you press “INFO” button you can see the detailed help information easily. And by pressing “INFO” button again you can exit Help menu.

• The starting time for EPG is the current time. You can see the event information for the next two hours. By pressing ▲ or ▼ button, you can go to the next/previous hours while Programmes list is highlighted.

• If you press the “SELECT” button when a next event is highlighted, a reminder is set for the highlighted programme and a clock appears on the screen. Programme reminders can be set to signal that a programme is about to start when you are watching another channel. If you set reminder to a programme, then you will be asked for switching to that channel when the reminder time is reached.



Displaying The Subtitles

With Digital terrestrial broadcasting (DVB-T), some programmes are broadcast with subtitles. Subtitles can be displayed when watching these programmes.

Press the “MENU” button to display the Main menu, highlight the Configuration line using ▲ or ▼ button and press the “SELECT” button to display the Configuration menu.

Highlight the **“Subtitle”** item in Configuration menu and use ◀ or ▶ button to set Subtitle to off or a language. If **“Subtitle”** is on via selecting one language option, pressing the **“TEXT”** button causes the following warning message display on the screen.

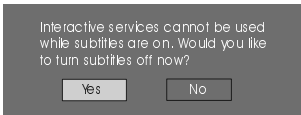

Digital Teletext

With Digital terrestrial broadcasting (DVB-T), in addition to pictures and sound, you can also watch digital teletext.

Digital teletext is sometimes broadcast at the same time as normal broadcasting.

1. Press the **“TEXT”** button.

The digital teletext information appears.

2. Operate it with the coloured buttons, ◀▶/▼/▲ buttons and SELECT button.

The operation method may differ depending on the contents of the digital teletext.

Follow the instructions displayed on digital teletext screen.

- When **“Press SELECT”** button or similar message appears on the screen, press the **“SELECT”** button.
- When the **“TEXT”** button is pressed, the TV returns to television broadcasting.
- With Digital terrestrial broadcasting (DVB-T), in addition to digital teletext broadcasting at the same time as normal broadcasting, there are also channels with just digital teletext broadcasting.
- The aspect ratio when watching a channel with just digital teletext broadcasting is the same as the aspect ratio of the picture watched previously.
- When you press the **“TEXT”** button again, the digital teletext screen is displayed.

Over Air Download

To ensure that your IDTV always has the most up-to-date information, please ensure that after use it is set to its standby mode. At 3AM each day, the IDTV automatically searches for any new information which may be broadcast and will download this to your IDTV automatically. This operation will normally take approximately 30 seconds.

If you want to do this, you need to set Automatic Download to **“Enabled”** in Receiver Upgrade setting. For details see [page 14](#).

Widescreen

Depending on the type of broadcast being transmitted, programmes can be viewed in a number of formats. Press the **“WIDE”** button repeatedly to select between **Auto, 4:3, 16:9, CINEMA, SUBTITLE, ZOOM** or **PANORAMA**.

When **Auto** is selected, the format being displayed is determined by the picture being broadcast.

Please Note: Menu size changes depending on the chosen image size.

IDTV Menu System

The IDTV menu can only be shown when watching Digital terrestrial broadcasting. Press the **“TV/DTV”** button to turn IDTV on while TV is in analogue mode.

Press the **“MENU”** button. The menu below appears on the screen:



Channel List

Using the ▲ or ▼ button on the remote control in Main menu, make sure that the first item, Channel List, is highlighted and press the **“SELECT”** button to display the **Channel List**.

The following operations can be performed in this menu:

1. Navigating the whole list of channels
2. Deleting channels
3. Renaming channels
4. Adding locks to channels
5. Setting favourites

Channel List is the place where the channels are managed.

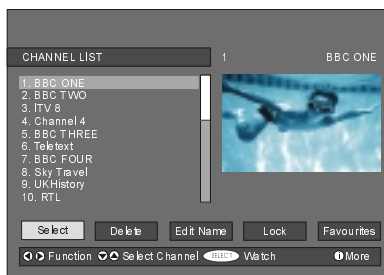

Navigating the whole channel list

Press ▲ or ▼ button for selecting the previous or next channel. You can press ▲ or ▼ button to move page up or page down.

To watch a specific channel, highlight it using ▲ or ▼ button and then press “SELECT” button, while the “Select” item on Channel List menu is highlighted by using ◀ or ▶ button.

Then the name and number of the selected channel will be displayed in the top-left and top-right of the channel display at the top-right of the screen, respectively.

Deleting the channels in the channel list

Press ▲ or ▼ button to select the channel that will be deleted.

Press ◀ or ▶ button to select the “Delete” item on Channel List menu. As seen on Channel List menu, **SELECT** is written next to **Delete** item at the bottom of the screen to indicate that pressing the “SELECT” button deletes the highlighted channel in the channel list.



Press the “SELECT” button to delete the highlighted channel in the channel list. Then the message below appears on the screen.

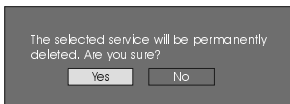

Press ◀ or ▶ button to highlight the desired option. If “SELECT” button is pressed while “Yes” is highlighted, the highlighted channel is deleted. Selecting “No” cancels the delete operation.

Renaming channels

To rename a specific channel, the channel must be highlighted via pressing ▲ or ▼ button and then highlight the **Edit Name** item by pressing ◀ or ▶ button. Press the “SELECT” to activate rename feature.

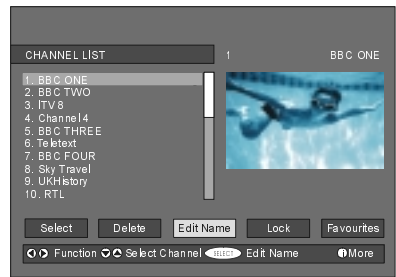

Now pressing ◀ or ▶ button moves to the previous/next character. Pressing ▲ or ▼ button toggles the current character, i.e., ‘b’ character becomes ‘a’ by ▼ and ‘c’ by ▲. Pressing the numeric buttons ‘0...9’ replaces the highlighted character with the characters printed above the button one by one as the button is pressed.

Press the “MENU” button to cancel the editing or “SELECT” button to save the new name.

Adding locks to channels

Channel Locking provides a password-protected access to channels selected by parents. In order to lock a channel you should know the Parental Lock password (default value is set to 0000 in the factory and can only be changed from the **Configuration Menu**).

Select the channel to be locked by highlighting it and select the “Lock” option by pressing ◀ or ▶ button. When the “SELECT” button is pressed, a password box is displayed.

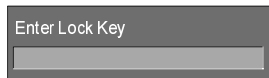
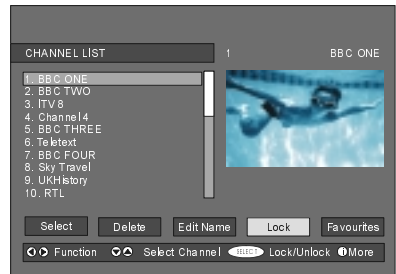

Enter the password using the digit buttons on the remote control. The Lock icon  will now be displayed next to the selected channel. Repeat the same operation to cancel the Lock.

Setting Favourites

You can set various channels as favourites so that only the favourite channels are navigated. To set a favourite you should highlight the “**Favourites**” item at bottom of the Channel List menu.

Use the ◀ or ▶ button to highlight the “**Favourites**” item at the base of the screen and then, in turn, highlight each channel you want to add to the favourites list, using the ▲ and ▼ buttons (or ▲ / ▼ buttons), and press the “**SELECT**” button.

A channel selected as a favourite appears in the main channel list with a favourites icon (😊) against the channel name.

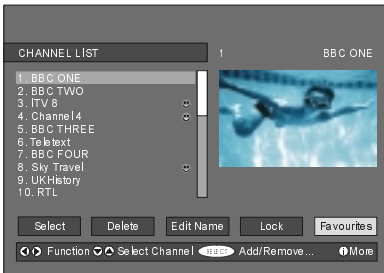

On Screen Help Pressing INFO Button

For all menus press the “**INFO**” button to display the help information about the menu functions. For **Channel List** menu the following message is displayed on the screen.

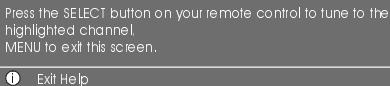

Installation

The Installation menu mainly intends to help you for building a **Channel Table** in most efficient way.

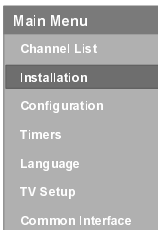

This menu includes the following items:

1. Add New Channels
2. First Time Installation.

ADD NEW CHANNELS:

This tuning menu consists of two parts:

- Automatic Search
- Manual Search



Automatic Search:

Automatic search is started by pressing the “**SELECT**” button in the auto-search pop up menu. All the services are searched and a channel table is created automatically.

All channels found are stored in a sorted form with respect to their channel numbers. Some services may not appear with the correct channel number. At the time of printing, not all broadcasters are sending their channel number information.

Manual Search:

In manual search, the number of the multiplex is entered manually and only that multiplex is searched for the channels. For every valid channel number, signal level, signal quality and network name are shown at the bottom of the screen.

In both manual and auto search any existing channel in the database is not re-stored to avoid redundant duplicates of that channel.

FIRST TIME INSTALLATION

The user can use this item to load default settings, which had been loaded to the receiver at the factory.

To install factory settings, highlight “**First Time Installation**” menu and press the “**SELECT**” button, then you will be asked to confirm for deleting all channels and settings.

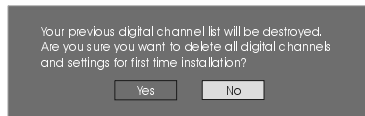
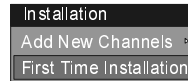

By selecting YES and pressing the “**SELECT**” button, the existing channel table will be deleted.

After factory settings is loaded, “**First Time Installation**” menu will be displayed.

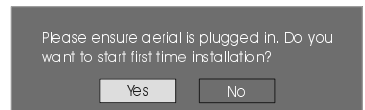

Press the “**SELECT**” button to start installation. After searching is completed for digital channels, a message asking search for analogue channels appears on the screen.

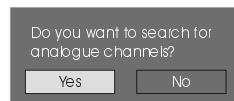

Press the “**SELECT**” button to search for analogue channels. The following menu appears on the screen for analogue channel search.

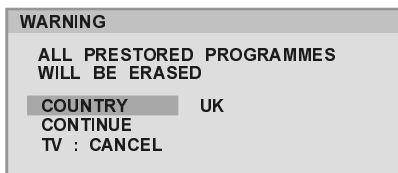

By pressing ◀ or ▶ button, adjust the “**Country**” item.

Press ▼ button to select “Continue” item and ◀ / ▶ or “**SELECT**” buttons to start APS operation.

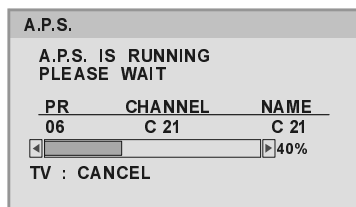

After APS is finalized, the programme table will appear on the screen. In the programme table you will see the programme numbers and names assigned to the programmes.

If you do not accept the locations and / or the programme names, you can change them in the Program menu. (See page 20 for Program table explanation.)

Configuration

Press the “**MENU**” button to display the Main Menu and the ▼ button twice to highlight Configuration, then press the “**SELECT**” button to display the Configuration menu. Press the “**MENU**” button to leave the menu.

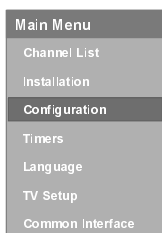

The various configuration functions are displayed in a list, along with a quarter-screen image of the currently selected channel. You can select a function by highlighting the corresponding menu line using the ▲ or ▼ button.



Audio Language

Digital terrestrial television channels can broadcast simultaneous soundtracks in more than one language. This function selects which language soundtrack you will hear when switching to a channel broadcasting with the multiple soundtracks.

Highlight the **Audio Language** line in the Configuration menu and use the ◀ or ▶ button to cycle through the language options.

Subtitle

Digital terrestrial television channels can broadcast subtitles displayed on-screen for the hard-of-hearing. This function selects the desired subtitle language and enables the automatic display of subtitles whenever subtitle information is broadcast.

Highlight the Subtitle line in the Configuration menu and use the ◀ or ▶ button to cycle through “**Off**” and language options.

Favourite Mode

This function enables or disables the favourite channel list mode. See Channel List menu Favourites on page 12.

Use ◀ or ▶ button to turn on/off favourite mode. If the “**Favourite Mode**” is on, in normal operating mode pressing “**P+**” and “**P-**” buttons will only navigate through the channels that were previously defined as favourites in Channel List.

EPG Preference

Digital terrestrial television channels can broadcast simultaneous Next&Now and 7-Day electronic programme. Highlight the EPG Preference line in the Configuration menu and use the ◀ or ▶ button to select **Next&Now** or **7-Day**.

Receiver Upgrade

The IDTV can be upgraded via the configuration menu, entered from the main menu.

In the Configuration menu, highlight the “**Receiver Upgrade**” item by pressing ▲ or ▼ button and press the “**SELECT**” button to start upgrade process.

There are two possibilities for Receiver software to be upgraded: **automatic** and **manual**.

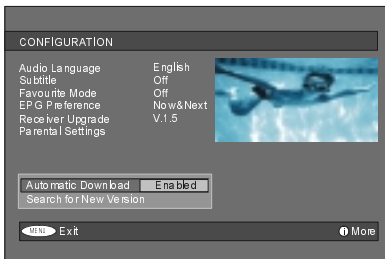

Automatic Download (Automatic upgrade)

Automatic Download can be enabled or disabled by pressing ◀ or ▶ button. If it is enabled, then there are two ways for automatic upgrade. The first one is checking the existence of a new software every time the IDTV goes to standby. The second one is waking up at 03:00 a.m. every night, provided that the IDTV is left in standby mode. Both automatic upgrade methods result in standby mode either upgraded or not.

If the automatic upgrade is set to "Disabled" then this function will not work.

Search For New Version (Manual upgrade)

Manual upgrade starts if the "Search for New Version" item is highlighted by using ▲ or ▼ button and activated via pressing the "SELECT" button.

After "Search for New Version" is activated, the IDTV tunes to each frequency that have been stored in its database and looks for the new software.

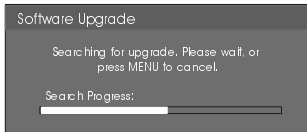

Parental Settings

Some channels broadcast material which you do not want younger members of the family to watch. Any channel can be 'locked' so that it cannot be selected for viewing without first a four-digit PIN code being entered. In this way any channel not suitable for younger viewers can be protected.

This function enables or disables the menu protection system and allows the PIN code to be changed.

Use ▲ or ▼ button to go to Parental Settings option. Press the "SELECT" button to enter Parental Settings Menu. A box asking for the lock key is displayed.

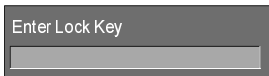

There is only one key which is set to "0000" initially. Enter lock key. If wrong Lock key is entered, the following message is displayed on the screen and it is returned back.



If it is correct, the Parental Settings Menu including following items is displayed:



There you can set/reset locking for the Main Menu, or the Installation Menu to restrict access. If the menu lock is disabled, there will be free access to the menu system. Also in this menu you can change the lock key and set/change parental lock mode.

Disabled: All menus are unlocked.

Main Menu: Main menu is accessible only with the correct lock key. So the user cannot add, delete, rename, move channels, cannot set timers.

Installation: Installation menu is locked, so the user cannot add channels.

Changes will be updated after exiting Configuration Menu.

Timers

Display the Main Menu by pressing the "MENU" button. Highlight the **Timers** line by pressing ▲ or ▼ button and press the "SELECT" button to display the Timer menu.

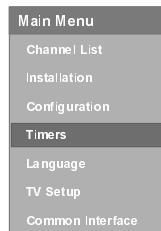

Up to five separate timer events can be set and each is displayed in the Timer screen, showing the event number, the channel to be selected, the start time, end time, date and the mode - whether that event is active (and will be acted on) or not.

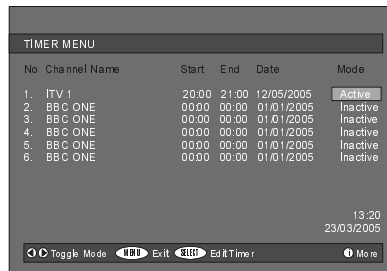

• To set an event, highlight its mode button using the ▲ or ▼ button and press the "SELECT" button to display the timer entry window.

Name:	3. ITV 1
Start:	00:00
End:	00:00
Date:	03/06/2005
Mode:	Once

• Here the five settings of channel name, start time, end time, date and frequency mode can be set. You can move freely between each setting using the ▲ or ▼ buttons.

• The channel name is set using the ◀ or ▶ button to display the channel which broadcasts the programme.

• The start time, end time and date are each set with the digit buttons on the remote control in 24-hour format.

• The frequency mode determines how often the receiver operates this event and is set with the ◀ or ▶ button to be either **Once**, **Daily**, or **Weekly**.

If an invalid number for the start or end times or the date is entered, "Entered time is not valid" message appears on the menu.

Language

Some programmes are broadcast in two or more languages simultaneously. The language heard can be selected from the Language Menu.

• Press the "MENU" button to display the Main Menu and use ▲ or ▼ button to highlight the Language line and press the "SELECT" button.

Main Menu
Channel List
Installation
Configuration
Timers
Language
TV Setup
Common Interface

• Use the ▲ or ▼ button to highlight the soundtrack language required and press the "SELECT" button. Normal viewing, with the required language soundtrack, can be resumed by pressing the "MENU" button.

Languages
English

• If the programme has no alternative language soundtrack broadcast, the Language Menu will not be available, but a message, "**No Multi Language Available**" is displayed briefly.

TV Setup

To be able to go through TV functions, you can use this item.

The digital TV Setup menu screen is accessed from the main menu. Press the "MENU" button to display the main menu and use ▲ or ▼ button to highlight "TV Setup", press the "SELECT" button to display TV Setup menu screen.

Main Menu
Channel List
Installation
Configuration
Timers
Language
TV Setup
Common Interface

Detailed information about Sound, Picture and Feature menus are in AnalogueTV Menu System section on page 16.

Common Interface

• Press the "MENU" button to display the Main Menu and use the ▲ or ▼ button to highlight the "Common Interface" line and press the "SELECT" button.

Main Menu
Channel List
Installation
Configuration
Timers
Language
TV Setup
Common Interface

It is required to subscribe to a pay channel company to view the pay channels of the Digital Terrestrial broadcasting.

Obtain the Conditional Access Module (CAM) and the Viewing card by subscribing to a pay channel company, then insert those to the Television using the following procedure.

1. **Switch off the TV and unplug from the mains.**
2. **Insert the CAM, then Viewing Card to the slot that is located on the back cover of the TV.**

• The CAM should be correctly inserted, it is impossible to insert fully if reversed. The CAM or the TV terminal may be damaged if the CAM is forcefully inserted.

3. **Connect the TV to the mains supply, switch on and then wait for few moments until the card is activated.**

• Some CAMs may require the following set up. Please set the CAM by entering the IDTV menu, Common Interface then pressing the "SELECT" button. (CAM set up menu is not displayed when it is not required.)

• To see the viewing contract information:

Enter IDTV; press the "MENU" button, then highlight **Common Interface** and press the "SELECT" button.

• When no module is inserted, "**No Common Interface module detected**" message appears on the screen.

• Refer to the module instruction manual for details of the settings.

Analogue TV Menu System

Your TV has been designed with a menu system, to provide an easy manipulation of a multi-function system. The TV is controlled by choosing the commands, which are displayed on the screen.

Press the "MENU" button. The **MENU** will be displayed in the middle on the screen.

All the selected items in this menu system is indicated with **HIGHLIGHTED** characters.

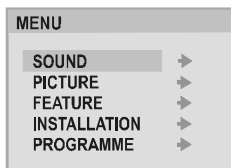

To select a sub-menu use ▲ or ▼ button and press ◀ or ▶ button.

MENU

The menu system is described below.

Direct access to some menus can be achieved using the following buttons on the remote control.

"MENU" Button,	Menu.
Red Button,	Equalizer Modes.
Green Button,	Picture Modes.
Yellow Button,	Feature Menu.
Blue Button,	Installation Menu.
"INFO" Button,	Program Menu.

"MENU" button has two functions; first is opening or closing the menu, and the second is closing the sub-menu and then opening its parent menu.

Sound Menu

- As you enter the **MENU**, sound will be the first selected option. In the **MENU**, select **SOUND** using ▲ or ▼ button, then enter the Sound menu by pressing ◀ or ▶ button.

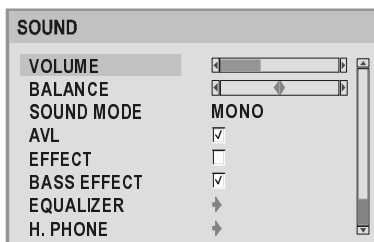

Setting Volume

As you enter the sound menu, Volume will be the first selected option.

- Press ▶ button to increase volume.
- Press ◀ button to decrease volume.

Or you can directly change the volume settings using "V+" (to increase) or "V-" (to decrease) button.

Setting Balance

It allows adjusting the distribution between the left and right speakers.

- Using ▲ or ▼ button select Balance.
- Press ▶ button to change balance to the right.
- Press ◀ button to change balance to the left.

When balance control is in mid position, the cursor is displayed with two reciprocal arrows.

Selecting Sound Mode

- Using ▲ or ▼ button select Sound Mode.
- Press ◀ or ▶ button to change Mode.

You can select **MONO**, **STEREO**, **DUAL-I** or **DUAL-II** mode, only if the selected channel supports that mode.

In case of bilingual broadcast (Dual Sound), you can select original or dubbed language using mode option.

You can also change sound mode directly by pressing "I-II" button on your remote control.

Setting AVL

Automatic Volume Limiting (AVL) function adjusts the sound to obtain fixed output level between programs, having different sound levels.

Pressing ◀ or ▶ button will turn on or off this feature.

Setting Effect

You can use this feature to switch the sound effect on or off. If the current sound system is Mono and the sound effect is switched on, then the sound will be heard as if it is Stereo. If the current sound system is Stereo, switching this effect on will make the sound deeper. Switching it off will make no change in Mono and Stereo.

Pressing ◀ or ▶ button will turn this feature on or off.

Setting Bass Effect

This function is used to reinforce the bass sound and create a more powerful sound.

By pressing ▲ or ▼ button, select **bass effect**. Press ◀ or ▶ button to turn the bass effect on or off.

Equalizer

To enter Equalizer sub-menu, select Equalizer using ▲ or ▼ button, then enter Equalizer menu by pressing ◀ or ▶ button.

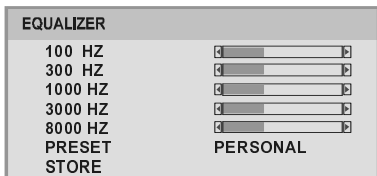

In **Preset** item there are four predefined and one user defined options. These are **PERSONAL**, **MULTIMEDIA**, **MUSIC**, **THEATRE** and **SPEECH**. The predefined options can not be changed by the user. Only the **PERSONAL** option may be adjusted by the user.

There are 5 frequency values to be adjusted: 100 Hz, 300 Hz, 1000 Hz, 3000 Hz and 8000 Hz. To change the values of 5 frequency options, select one of the options by **▲** or **▼** button, and then press **▶** to increase the value or **◀** to decrease the value.

You can also change equalizer modes by pressing the **RED** button on your remote control.

To store the Equalizer settings, press **◀** or **▶** button on **“Store”** option.

To Change Headphone Sound Settings

By pressing **◀** or **▶** button on **H. Phone**, enter the Headphone menu.

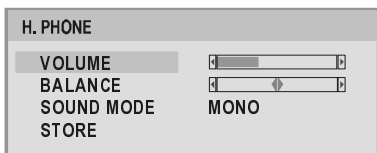

Setting Headphone Volume

- As you enter the Headphone sound menu, Volume will be the first selected option.
- Press **▶** button to increase volume.
- Press **◀** button to decrease volume.

Setting Headphone Balance

- Using **▲** or **▼** button select Balance.
- Press **▶** button to change balance to the right.
- Press **◀** button to change balance to the left.

When balance control is in mid position, the cursor is displayed with two reciprocal arrows.

Setting Headphone Sound Mode

- Using **▲** or **▼** button select **Sound Mode**.

Pressing **◀** or **▶** button will change the current sound mode. (e.g.: If the current sound mode is stereo, it will be stereo or visa versa).

In case of bilingual broadcast, you can select original or dubbed language again using mode menu. So when somebody listens to the original language from the loud-

speakers, somebody else can listen to the dubbed language from headphone.

To Store the Headphone Settings

- Using **▲** or **▼** button select Store. Press **◀** or **▶** button to store current headphone volume and balance. “STORED” will be displayed. The stored values will be valid for all the programmes.

To Store the Settings

- Press **◀** or **▶** button on **“STORE”** option to store Sound menu settings.

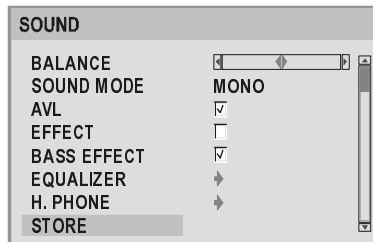

Picture Menu

- Press **“MENU”** button, now you are in **MENU**. In the **MENU**, select **PICTURE** using **▲** or **▼** button, then enter the Picture menu by pressing **◀** or **▶** button.

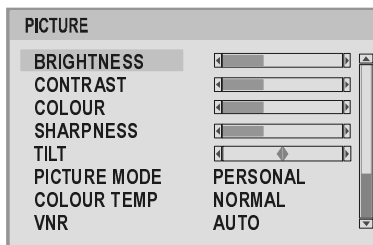
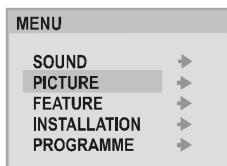

Setting Brightness

- As you enter the picture menu, Brightness will be the first selected option.
- Press **▶** button to brighten the picture.
- Press **◀** button to darken the picture.

Setting Contrast

Contrast is the difference and distribution of light and dark tones in an image.

- Using ▲ or ▼ button select Contrast.
- Press ► button to increase contrast level.
- Press ◀ button to decrease contrast level.

Setting Colour

- Using ▲ or ▼ button select Colour.
- Press ► button to increase colour saturation.
- Press ◀ button to decrease colour saturation.

Setting Sharpness

- Using ▲ or ▼ button select Sharpness.
- Press ► button to sharpen the picture.
- Press ◀ button to soften the picture.

Setting Tilt

This function is used for tilt correction of the picture.

- Using ▲ or ▼ button select Tilt.
- Press ► button to rotate the picture to the right.
- Press ◀ button to rotate the picture to the left.

Setting Hue (In AV mode only)

(During Playback NTSC system, this will appear in AV mode only when NTSC video source is applied. Otherwise, HUE option is invisible in Picture menu.):

- Using ▲ or ▼ button select Hue.
- Press ► button to increase the green tones.
- Press ◀ button to increase the red tones.

Center value is indicated with two reciprocal arrows.

Setting Picture Mode

This item is used to change the picture mode. By pressing ◀ or ► button you may select one of these options: **PERSONAL, SPORT, MOVIE, WEAKSIGNAL.**

You can also change picture modes by pressing the GREEN button on your remote control.

Setting Colour Temp

This item is used for white colour tint adjustment. By pressing ◀ or ► button you may select one of these options: **WARM, COOL, NORMAL.**

Setting VNR (Video Noise Reduction)

This item is used to reduce the image noise and improve the picture quality at weak signals.

- Using ▲ or ▼ button select VNR.
- Press ◀ or ► button to set VNR level to **OFF, MIN, AUTO** or **MAX.**

AUTO adjusts the VNR level to **OFF, MIN** or **MAX** automatically according to the intensity of the noise.

Setting Zoom

You can change the screen size according to the picture aspect ratio. Select the optimum one from the following **ZOOM** modes:

AUTO:

When a **WSS (Wide Screen Signalling)** signal, which shows the aspect ratio of the picture, is included in the broadcast signal or the signal from an external device, the TV automatically changes the **ZOOM** mode to **16:9** mode or **4:3** mode according to the **WSS** signal.

- When the **AUTO** mode does not function correctly due to poor **WSS** signal quality or when you want to change the **ZOOM** mode, change to another **ZOOM** mode manually.

Using the different screen formats

Press the ◀ or ► button to select the different modes: **4:3, 16:9, CINEMA, SUBTITLE, ZOOM** and **PANORAMA.**

You can also access these settings by pressing the "☒" button.

4:3



16:9

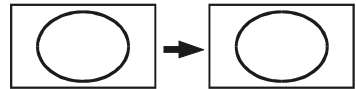

CINEMA

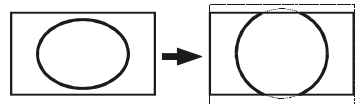

SUBTITLE

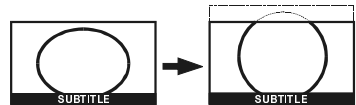

ZOOM

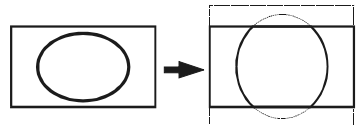

PANORAMA

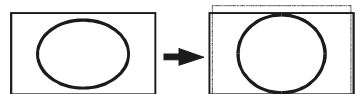

Setting VCR Mode (In AV mode only)

- Using ▲ or ▼ button select VCR Mode.
- When you watch a picture from your VCR and the picture is unstable, you may improve it by changing the "VCR MODE" setting from "ON" to "OFF".

To Store the Settings

- Press ◀ or ▶ button on **STORE** option to store Picture menu settings.

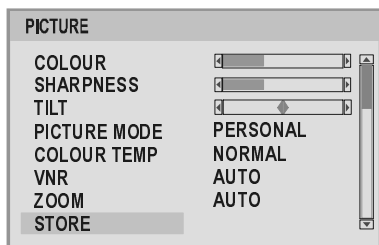

Feature Menu

- To enter the **Feature** menu directly, press the Yellow button, or
- Press "MENU" button, now you are in **MENU**. In the **MENU**, select **FEATURE** using ▲ or ▼ button. Then enter the Feature menu by pressing ◀ or ▶ button.

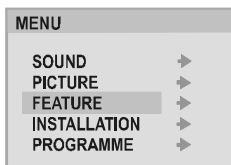

Sleep Timer

As you enter the **Feature** menu, **Sleep Timer** will be the first selected option. Use ◀ or ▶ button to change the Sleep Timer value to **OFF, 5, 10, 15, 20, ..., 115 or 120**.

If sleep timer is activated, at the end of the selected time, the TV goes automatically to stand-by mode.

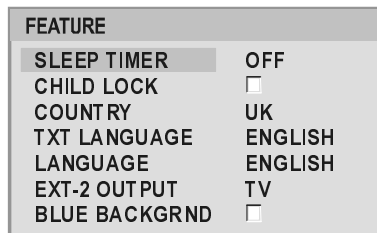

Child Lock

You can use this feature to prevent children turning on TV or changing programs or adjustments etc. without remote control.

The **Child Lock** feature can be set by ◀ or ▶ button to either **ON** or **OFF**. When **OFF** is selected, there will be no difference in the operation of your TV. When **ON** is selected, the TV can only be controlled by the remote control handset. In this case, the front panel buttons (except the Power On/Off button) will not work.

If Child Lock is ON, when one of the front panel buttons (except power button) is pressed, "**CHILD LOCK**" warning is seen on the screen.

Selecting Country

- Using ▲ or ▼ button select Country.
- Press ◀ or ▶ button to select the desired country settings.

Selecting Text Language

Text language can be selected by pressing ◀ or ▶ button on **Txt Language** item.

Selecting Language

Menu language can be selected by pressing ◀ or ▶ button on **Language** item.

EXT-2 Output

- Using ▲ or ▼ button select EXT-2 Output.
- Press ◀ or ▶ button to select the source which will be given. From EXT-2 output, either TV, EXT1, DTV or FAV can be selected.

Blue Background During No-Signal

In case, no valid signal is detected Blue Background is activated. During search process Blue Background is not active. But instead of it there is another feature given; the semi-transparent menu background is made blue.

Blue Background feature can be switched on or off by pressing ◀ or ▶ button.

To Store Settings

In **Feature** menu all settings are stored automatically.

Installation Menu

- To enter the **Installation** menu directly, press the **BLUE** button, or
- Press "MENU" button, now you are in **MENU**. In the **MENU**, select **INSTALLATION** using ▲ or ▼ button. Then enter the Installation menu by pressing ◀ or ▶ button.

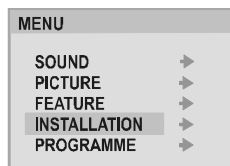

Tuning Mode

Selecting Channel

- Press ▲ or ▼ button to select “**Tuning Mode**”. By pressing ◀ or ▶ button, you can select the mode in which you want the search to be made, “**Channel**” mode or “**Frequency**” mode.

When you select “**Channel**” the display of the Installation Menu will be as below :

INSTALLATION	
PROGRAMME	01
BAND	C
CHANNEL	12
DECODER	<input type="checkbox"/>
FINE TUNING	◀ [] ▶
SEARCH	
TUNING MODE	CHANNEL
STORE	

Selecting Programme

To select programme number, you can use ◀ or ▶ button or Digit Buttons.

Selecting Band

BAND, can be selected either “C” or “S” by pressing ◀ or ▶ button.

Selecting Channel

CHANNEL can be changed by ◀ or ▶ button or Digit Buttons.

For band C,

01 - 17, 21 - 73

For band S,

01 - 41

Selecting Decoder

You can use this mode to connect any decoder to your TV.

- Press the ◀ or ▶ button to turn it ON or OFF.

When you switch Decoder OFF, EXT2 output will be muted. If it is switched ON the EXT-2 output will be the selected video source. Any decoder can be connected to EXT2 to unscramble required video signal.

Decoder setting should be stored separately for each programme.

Selecting Fine Tuning

You can use the Fine Tuning process for fine adjustment (after coarse adjustment), if you are not happy with the image on the screen.

Use ◀ or ▶ button on **FINE TUNING** item, until getting the best image on the screen.

In Channel option, normally the Fine Tuning cursor is placed at the middle on the slider, and this is indicated with two reciprocal arrows.

Selecting Search

- Using ▲ or ▼ button select Search item.
- Press ◀ or ▶ button in order to start channel search. “**SEARCHING...**” is displayed during the search process. Searching is stopped as soon as a station is found or ▲, ▼, ◀, ▶ buttons are pressed.

To Store Settings

Press ◀ or ▶ button on **STORE** option to store Installation menu settings.

Selecting Frequency

- When you select Tuning Mode as “**Frequency**”, the display of the Installation menu will be as below :

INSTALLATION	
PROGRAMME	01
FREQUENCY	175.25 Mhz
DECODER	<input type="checkbox"/>
SEARCH	
TUNING MODE	FREQUENCY
STORE	

Installation menu settings for “Frequency” mode are identical to “Channel” mode except the Frequency adjustment.

Selecting Frequency

FREQUENCY can be changed by ◀ or ▶ button or the Digit buttons.

Programme Menu

- To enter Programme menu directly, press the **INFO** button, or
- Press “**MENU**” button, now you are in **MENU**. In the **MENU**, select **PROGRAMME** using ▲ or ▼ button. Then enter the Programme menu by pressing ◀ or ▶ button.

MENU	
SOUND	➤
PICTURE	➤
FEATURE	➤
INSTALLATION	➤
PROGRAMME	➤

PROGRAM		PR 01	
01	C 12	11	----- 21
02	C 23	12	----- 22
03	C 45	13	----- 23
04	C 47	14	----- 24
05	C 50	15	----- 25
06	C 55	16	----- 26
07	-----	17	----- 27
08	-----	18	----- 28
09	-----	19	----- 29
10	-----	20	----- 30
■ NAME		■ INSERT	
■ DELETE		■ AUTOSTORE	

Moving cursor to four directions you can reach 30 programmes in the same page. You can scroll the pages up or down by pressing the navigation buttons.

By cursor action, programme selection is done automatically.

Programme Number is between 00 and 99. Programme Name has a name string with 5 characters. After autostore process the Programme Names are set to:

- Channel search "C01" or "S01" (band and channel number), as default.

At the bottom of the menu there is a programme sort functions section. Each function is activated by a colour button. **NAME**, changes the programme name. **DELETE**, deletes undesired programmes. **INSERT**, inserts a programme into another programme's position. By selecting **AUTOSTORE**, Autostore menu will be available

NAME:

You can change the name of a selected programme by pressing the **RED** button (**NAME**). First letter of the selected programme is displayed with a highlighted character. To change that letter **▲** or **▼** button can be used, and to select the other letters, **◀** or **▶** button can be used.

After changing the name, press the **RED** button to store the new name or press the **BLUE** button to cancel.

INSERT:

When the **GREEN** button (**INSERT**) is pressed, "**NAME**", "**AUTOSTORE**" and "**DELETE**" functions are erased and the selected programme is displayed with green characters. Use the navigation buttons to select another programme's position. When the **GREEN** button is pressed again, the first selected programme will be inserted into the position of the current selection.

Press the **BLUE** button to cancel the activated "**INSERT**" process.

DELETE:

Press the **YELLOW** button to delete an existing programme. When the **YELLOW** button is pressed again the selected programme will be deleted.

Pressing the **BLUE** button cancels the activated "**DELETE**" process.

AUTOSTORE:

(A.P.S. (Automatic Programming System))

A.P.S. searches and sorts all channels and stores them automatically on your TV, according to the transmission of programme systems in your area.

To enter Autostore menu, press the **BLUE** button.

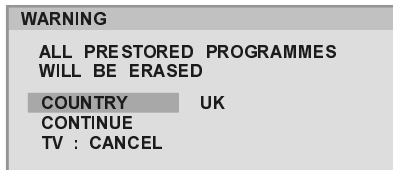

- If you do not want to start **A.P.S.**, you can cancel it by pressing the "**TV/DTV**" button on your remote control.
- First select your country by pressing **◀** or **▶** button. This will affect the sort process in APS.
- To select "**Continue**" use **▲** or **▼** button. By pressing **◀** or **▶** button start the **A.P.S.**
- When you start **A.P.S.** the following window will appear on the screen.

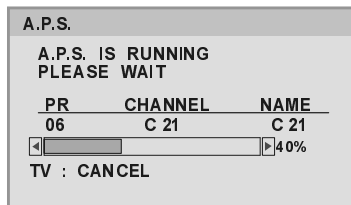

After APS is finalized, a programme list will appear on the screen. In the programme list you will see the programme numbers and names assigned to the programmes.

If you do not accept the locations and / or the programme names of programmes, you can change them in Programme menu.

Other Features

TV Status

Programme Number, Programme Name (or AV) and Sound Indicator are displayed on the left upper side of the screen for 3 seconds when a new programme is entered by a digit button or when "P<P", "P+ / P-", "TV/DTV" buttons are pressed.

Programme Swap (P<P)

This button is used to reenter to the preceding entered programme again. Pressing "P<P" consecutively allows to swap between two programmes.

Double-digit (- -)

- - is displayed when the "Double-Digit" button is pressed.

After this, you can enter a programme by pressing two digit buttons consecutively. If you do not press a button within 3 seconds this function will be ignored and the display will be erased. Likewise, you must enter the second digit within 3 seconds of entering the first digit.

Sound Indicator

This indicator is displayed under the programme number indicator on the screen. "I-II" button is used to select Mono, Stereo, Dual-I or Dual-II.

In Mono broadcast or in forced-mono (for stereo broadcast),

MONO

In Stereo broadcast,

STEREO

If dual broadcast is detected, Dual-I is selected in default.

DUAL-I

Dual-II is selected by Remote Control.

DUAL-II

Zoom

By pressing "EX" (TXT_UPDATE) button (if Teletext is not active) the zoom mode can be changed to "AUTO", "4:3", "16:9", "CINEMA", "SUBTITLE", "ZOOM" or "PANORAMA".

Mute Indicator

It is placed on the upper middle of the screen when enabled, and it stays there until it is disabled.



To cancel mute, there are two alternatives; the first one is pressing the "X" button, thus volume is set to the preceding value, and the second one is increasing the volume level, thus it starts from the minimum level to increase. By decreasing the volume level in mute state, mute will not be ignored, only the volume level will decrease. If mute is canceled after decreasing the volume level, the volume will be valid with the decreased level.

Volume Bar

It is displayed on the lower middle of the screen when a volume button is pressed (Volume buttons on Remote Control or Front panel).



AV Modes

By pressing the "AV" button you can switch your TV to AV modes (except being in Teletext). Pressing this button will switch the TV in one of the optional AV modes: EXT1, EXT2, EXT2S or FAV. EXT2 supports the S-Video mode.

In order to quit the AV mode press the "TV/DTV", digit buttons or "P+ / P-".

Teletext

Teletext is an information system that displays text on your TV screen. Using the Teletext information system you can view a page of information on a subject that is available in the list of contents (index).

On screen display is not available in text mode.

Contrast, brightness or colour control is not available, but volume control is available in text mode.

To operate Teletext

- Select a TV station on which Teletext is being transmitted.
- Press "TEXT" button. Usually the list of contents (index) is displayed on the screen.

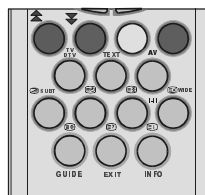

To select a page of Teletext

- Press the appropriate digit buttons for the required Teletext page number.

The selected page number is displayed at the top left corner of the screen. The Teletext page counter searches until the selected page number is located, so that the desired page is displayed on the screen.

- Press ▲ button to move the Teletext screen forward one page at a time.
- Press ▼ button to move the Teletext screen backward one page at a time.

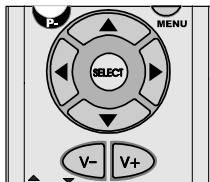

To Select Index Page

- To select the page number of the index (generally page 100), press "100" button.

To Select Teletext with a TV Programme

- Press "TV" button. The text is now superimposed over the programme on the screen.
- Press "TV" button again to return to the Teletext page.

Searching for a page while watching TV

- While Teletext Mode is on, pressing "TV" will change the mode to TV, one more press to "TV" will change the mode from TV to the latest Teletext page we left. In the Teletext mode enter a page number using digit keys and press "TV". Then you will see the "TV" icon flashing on the upper left side of the screen until the requested page is found. Then teletext icon will be replaced by page number to indicate that page has been found. Now you can display this teletext page pressing "TV" button.

To Select Double Height Text

- Press "TV" button for the upper half of the information page to be displayed in double height text.
- Press "TV" button again for the lower half of the information page to be displayed in double height text.
- Press "TV" button once more for the full page of normal height text.

To Reveal "concealed" Information

- Pressing "TV" button once will reveal answers on a quiz or games page.
- Pressing "TV" button again will conceal the revealed answers.

To Stop Automatic Page Change

The teletext page you have selected may contain more information than what is on the screen; the rest of the information will be displayed after a period of time.

- Press "TV" button to stop the automatic page change.
- Press "TV" button again to allow the next page to be displayed.

To Select a Subcode Page

Subcode pages are subsections of long Teletext pages that can only be displayed on the screen one section at a time.

- Select the required Teletext page.
- Press "TV" button.
- Select the required subcode page number by pressing four digit buttons (e.g. 0001).
- If the selected subcode page is not displayed in a short time, press "TV" button. TV programme will be displayed on the screen.
- Teletext page number will be displayed on the upper left corner of the screen when the selected page is found.
- Press "TV" button to display the selected Teletext page.

Split Screen

- To watch a TV programme and teletext at the same time on the screen this function is used.
- While watching a TV programme with teletext transmission press "TEXT" button.
- Teletext is displayed on the screen. Press "TEXT" button again. The screen is divided into two parts. TV program is displayed on the left side of the screen. Teletext is displayed on the right side of the screen.
- To exit split screen press "TEXT" button one more time.

To exit Teletext

- Press "TV/DTV" button. The screen will switch to TV mode.

To Display the Time

- While watching a TV programme with Teletext transmission press "TV" button. The current time information, captured from Teletext will be displayed at the upper right of the screen.
- If the programme being watched does not have Teletext transmission, no information will be displayed.

Fastext

Your TV supports the 7 page Teletext system. When the page number of any of the 7 pages in memory is entered, the system will not search for the requested page; instead it will display the page automatically.

- Press **▲** button to move the Teletext screen forward one page at a time.
- Press **▼** button to move the Teletext screen backward one page at a time.

For Fastext

The subject-heading for the information may have a particular colour.

- Press an appropriate **RED, GREEN, YELLOW** or **BLUE** button in order to reach the relevant page quickly.

For TOP text

TOP text mode of operation will be activated automatically according to the transmission.

- If TOP text transmission is present, colour coded buttons will appear in status row.
- If TOP text transmission is not present, status row will not appear.

The subject-heading for information may be located in coloured box.

In Top mode the **▲** or **▼** commands will request the next or previous page respectively. If TOP text transmission is not available, in case of operation of these commands, wraparound occurs. For example page 100 appears to be one greater than page 199.

Toptext has a special page called HITLIST which can be displayed by pressing the **⏏** button. Use colour buttons on HITLIST page to select a line which will link you to another teletext page.

Connect Peripheral Equipment

There is a wide range of audio and video equipment that can be connected to your TV.

The following connection diagrams show you where the different equipment should be connected at the back or the right side of the TV.

Via the Scart

Your TV set has two Scart sockets. If you want to connect peripherals (e.g. video, decoder, etc.) which have Scarts, to your TV, use optional **EXT.1** or **EXT.2** inputs.

If an external device is connected via Scart sockets TV is switched to AV mode automatically.

EXT2S Mode

If the equipment connected to your TV set supports S-Video (Y/C) output from Scart, you can have a better picture quality by selecting **EXT2S** mode and connecting your equipment to the **EXT.2** terminal of TV. See your equipment's booklet to check if your equipment has such feature.

Via Ant Input

If you want to connect to your TV, peripherals like video recorders or decoders, but the device you want to connect does not have Scart, you should connect it to the ANT input of your TV set.

If the VCR is connected via antenna input it is suggested to use Programme 0.

Decoder

Cable TV offers you a wide choice of programs. Most of them are free, others are to be paid for by the viewer. This means that you will need to subscribe to the broadcasting organisation whose programmes you wish to receive. This organisation will supply you a corresponding decoder unit to allow the programmes to be unscrambled.

For further information ask your dealer. See also the booklet supplied with your decoder.

Connect a decoder with an aerial socket to the TV

- Connect the aerial cable.

Connect a decoder without an aerial socket to the TV

- Connect the decoder to your TV with a scart cable to **EXT.1** or **EXT.2**. When your decoder has a Scart you can obtain better picture quality if you connect a scart cable to **EXTERNAL**.

TV and Video Recorder

- Connect the aerial cables.

Better picture quality can be obtained if you also connect a scart cable to **EXTERNAL** sockets.

Playback NTSC

Connect NTSC VCR player to Scart at the back of the TV.

Connect NTSC VCR player to RCA Jacks at the right side of the TV.

Then, press **"AV"** button to select EXT1, EXT2, EXT2S or FAV.

Search for and store the test signal of the video recorder

- Unplug the aerial cable from the aerial socket “**ANT**” of your video recorder.
- Switch on your TV and put the video recorder on the test signal. (See the handbook for your video recorder.)
- Enter the Installation menu.
- Search for the test signal of your video recorder in the same way as you searched for and stored the TV signals. See Tuning Mode, Search and Store TV channels. Store the test signal under programme number 0.
- Replace the aerial cable in the aerial socket “**ANT**” of your video recorder once you have stored the test signal.

Camera and Camcorder

To connect to Front-AV input (FAV):

Connect your camera or camcorder to **RCA Jacks** at the right side of your TV.

- Connect your equipment to the TV via **VIDEO** (yellow), **AUDIO R** (red) and **AUDIO L** (white) inputs. You should connect the jacks to the input in the same colour.

Connect the decoder to the video recorder

Some video recorders have a special scart for decoder.

- Connect a scart cable to the scart of your decoder and to the special scart of your video recorder. See also the handbook of your video recorder.
- To connect your video recorder to the TV, see TV and Video Recorder section.

If you want to connect more equipment to your TV, consult your dealer.

Connecting Headphones

Use the stereo headphone socket on the lower right side of your TV, to connect headphones.

Software Update Socket

The socket which is seen at the right side of the EXT.1 socket can only be used by the service personnel to update the software of the TV. Please do not try to connect any peripherals or insert any objects to this socket.

Connect Peripheral Equipment

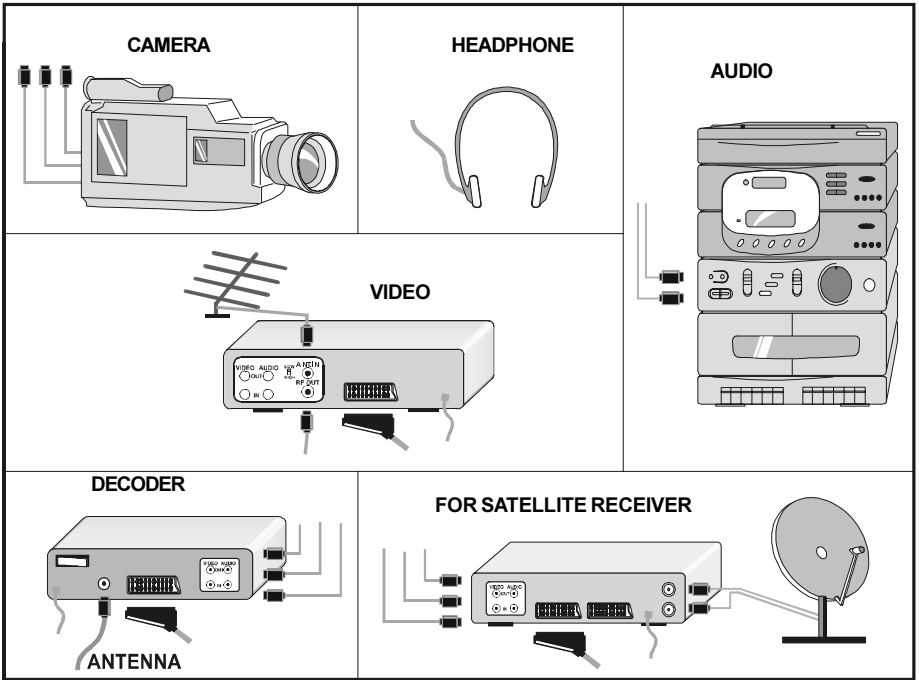

Antenna Connections

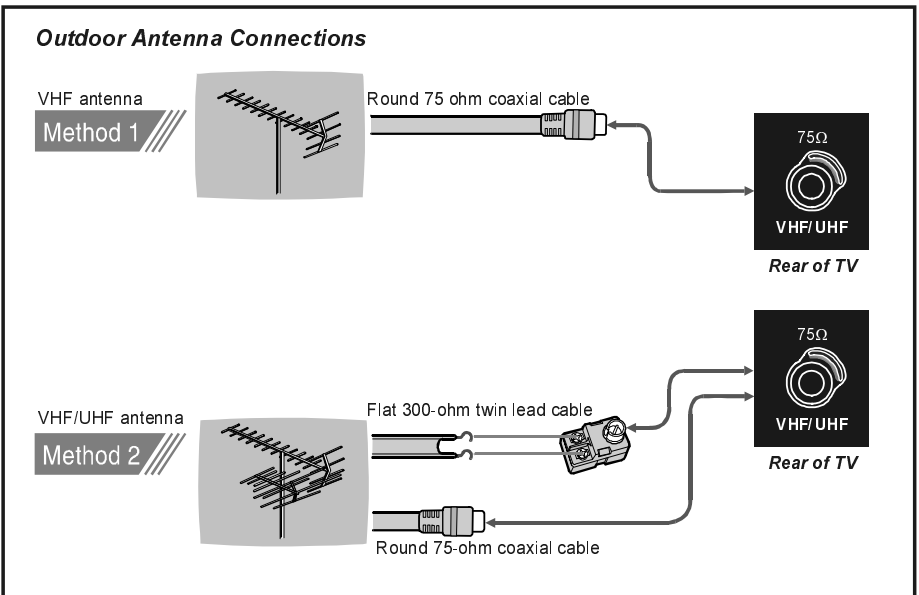

Tips

Care of the Screen

Clean the screen with a slightly damp, soft cloth. Do not use abrasive solvents as they may damage the TV screen coating layer.

Poor Picture

Have you selected the correct TV system? Is your TV set or house aerial located too close to the loudspeakers, non-earthed audio equipment or neon lights, etc.? Mountains or high buildings can cause double pictures or ghost images. Sometimes you can improve the picture quality by changing the direction of the aerial.

Is the picture or Teletext unrecognizable? Check if you have entered the correct frequency.

The picture quality may degrade when two peripherals are connected to the TV at the same time. In such a case, disconnect one of the peripherals.

No Picture

Is the aerial connected properly? Are the plugs connected tightly to the aerial socket? Is the aerial cable damaged? Are suitable plugs used to connect the aerial? If you are in doubt, consult your dealer.

No Picture means that your TV is not receiving any transmission. Have you pressed the correct buttons on the remote control? Try once more.

Sound

You can not hear any sound. Did you perhaps interrupt the sound, pressing "MUTE" button?

Sound is coming from only one of the speakers. Is the balance set to one direction extreme? See SOUND menu.

Remote Control

Your TV no longer responds to the remote control. Press the "TV" button on the remote control once more. Perhaps the batteries are exhausted. If so you can still use the local buttons at the front of your TV.

Have you selected the wrong menu? Press "TV/DTV" button to return to TV mode or press "MENU" button to return to the previous menu.

No solution

Switch your TV set off and on. If this does not work, call the service personnel; never attempt to repair it yourself.

Bad picture (in digital mode)

Although this TV can receive both Digital terrestrial broadcasting (DVB-T) and Analogue terrestrial broadcasting, you may not be able to receive DVB-T depending on the area in which you live.

If the picture freezes a lot, or block effect is seen frequently on screen, probably there is a problem with your reception.

Please contact customer services of your service provider if you are a subscriber.

Specifications

TV BROADCASTING

PAL I/1'

RECEIVING CHANNELS

VHF (BAND I/III)

UHF (BAND U)

HYPERBAND

CABLE-TV (S1-S20 / S21-41)

NUMBER OF PRESET CHANNELS

100

CHANNEL INDICATOR

OSD (ON SCREEN DISPLAY)

RF AERIAL INPUT

75 Ohm Unbalanced

OPERATING VOLTAGE

230-240V AC, 50 Hz

POWER CONSUMPTION (W) (max)

135 Watt

AUDIO OUTPUT

NICAM STEREO

AUDIO OUTPUT POWER (W_{RMS}) (%10 THD)

2x10 W

PICTURE TUBE

28" 16:9

DIMENSIONS (DxLxH) (mm)

D	L	H	Weight (kg)
480	790	500	41

Important Instruction

For your own safety read following instruction carefully before attempting to connect this unit to the mains supply.

MAINS (AC) OPERATION

The wires in the mains lead are coloured in accordance with the following code :

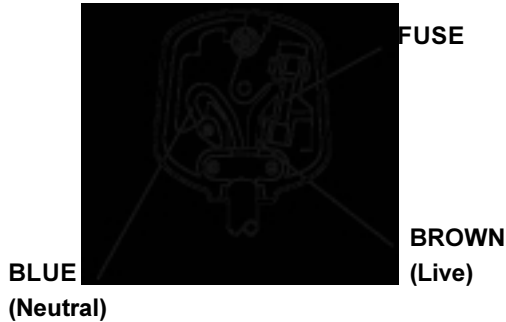

IMPORTANT

As the colours of the wires in the mains lead of this appliance may not correspond with the coloured markings identifying the terminals in your plug, proceed as follows:

The wire which is coloured blue or black must be connected to the terminal which is marked with the letter N or coloured Black.

The wire which is coloured brown or red must be connected to the terminal which is marked with the letter L or coloured Red.

No connection is to be made to the Earth terminal of the plug.

For continued protection against risk of fire, replace only with same type and rating of fuse (ASTA approved 5A 250VAC fuse).

If your product is fitted with a moulded plug which requires replacement please cut off and dispose of safely, then rewire as shown above.

CAUTION

TO PREVENT ELECTRIC SHOCK DISCONNECT FROM THE MAINS BEFORE REMOVING COVER. NO USER SERVICEABLE PARTS INSIDE. REFER SERVICING TO QUALIFIED SERVICE PERSONNEL.

SAFETY PRECAUTION

THIS EQUIPMENT MUST BE DISCONNECTED FROM THE MAINS WHEN NOT IN USE. DO NOT ALLOW THIS UNIT TO BE EXPOSED TO RAIN OR MOISTURE.