

Goodmans

GTV51N16DVD

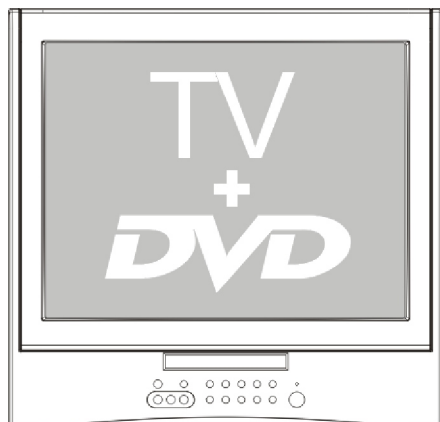

CONTENTS

Before Operation	2
Warning and cautions	3
Location of controls	4
Using the remote control	7
Basic operation	
Switching on/off the TV set	8
Searching channels	9
Full automatic mode	9
Semi-automatic search	10
Manual fine tune	11
Program skip	12
Watching TV	13
Watching TV program	13
Program swap and auto scan functions	14
Convenient picture and sound control functions	15
Multiple picture modes	15
Black stretch and noise reduce	16
Mute	17
Time functions	18
Clock setting and timer on/off functions	18
Sleep timer and program preset	19
Setup function	20
Screen saver and childlock functions	20
AVL and calendar functions	21
Position exchange function	22
Teletext	23
DVD Operation	
Basic Playback	25
Advanced Playback	26
Special Function Playback	27
DVD System Setup	28
Playable Discs	32
Disc Protection and DVD Characteristics	33
Others	
Connection to the external audio and video equipment	34
Trouble shooting guide	35
Specifications	36



Warning and cautions



CAUTION
RISK OF ELECTRIC SHOCK
DO NOT OPEN



CAUTION: TO REDUCE THE RISK OF ELECTRIC SHOCK. DO NOT REMOVE COVER (OR BACK). NO USER SERVICEABLE PARTS INSIDE. REFER SERVICING TO QUALIFIED SERVICE PERSONNEL.

The graphic symbols on the back cover of the set mean the following:



The lightning flash with arrowhead symbol within an equilateral triangle is intended to alert the user to the presence of uninsulated "dangerous voltage" within the product's enclosure that may be of sufficient magnitude to constitute a risk of electric shock to persons.



The exclamation point within an equilateral triangle is intended to alert the user to the presence of important operating and maintenance (servicing) instructions in the literature accompanying the appliance.

WARNING: TO REDUCE THE RISK OF FIRE OR ELECTRIC SHOCK, DO NOT EXPOSE THIS APPLIANCE TO RAIN OR MOISTURE.

INSTALLATION

LOCATE the receiver in the room where direct light does not strike the screen. Total darkness or a reflection on the picture screen can cause eyestrain. Soft and indirect lighting is recommended for comfortable viewing. ALLOW enough space between the receiver and the wall to permit proper ventilation. AVOID excessive warm locations to prevent possible damage to the cabinet or component failure.

CONNECTION

This TV receiver can be connected to 230V- 50Hz, NEVER connect to DC supply or any other power.

AUTOMATIC DEGAUSSING

All colour television receivers are sensitive to magnetic influences, usually caused by either moving the receiver from one place to another or using certain electrical appliances near the receiver. This residual magnetism as it is called, sometimes causes distortion which gives rise to "blotchy" areas of colour in the picture. To avoid these effects the receiver incorporates an automatic degaussing circuit which operates for a short while immediately each time the receiver is switched on using the mains switch. This circuit removes any residual magnetism in the metal parts of the picture tube and therefore ensures that each time the receiver is switched "ON" using the Mains switch, the purity of the colours displayed on the screen remain true and lifelike. If the set is moved or faced in a different direction, the mains switch must be switched off at least 10 minutes in order that the automatic degaussing circuit operates properly.

Warning and cautions

CAUTION

Never tamper with any components inside your set, or any other adjustment controls not mentioned in this manual. All television receivers are high voltage instruments. Your PICTURE TUBE is highly evacuated. If broken, glass fragments will be violently expelled. Scratching, shipping or undue pressure is dangerous and should be avoided. When you dust or wipe the PICTURE TUBE FACE or CABINET, the power cord should be pulled out from the wall then wipe the receiver with a dry soft cloth. All "inside work" on your receiver should be performed only by Professional Service Personnel.

DANGER



Invisible laser radiation when open and interlock failed or defeated. avoid direct exposure to laser beam.

LASER SAFETY

This unit employs an optical laser beam system in the CD mechanism, designed with built in safeguards. Do not attempt to disassemble, refer to qualified service personnel. Exposure to this invisible laser light beam may be harmful to the human eye.

THIS ISA CLASS-1 LASER PRODUCT. USE OF CONTROLS, OR ADJUSTMENTS OR PROCEDURES OTHER THAN THOSE SPECIFIED HEREIN, MAY RESULT IN HAZARDOUS LASER LIGHT BEAM

**CLASS 1
LASER PRODUCT**

Manufactured under license from Dolby Laboratories "Dolby", "Pro Logic" and the double-D symbol are trademarks of Dolby Laboratories. Confidential unpublished works. c.1992-1997 Dolby Laboratories, Inc. All rights reserved.

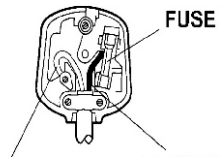

LOCATION OF CONTROLS

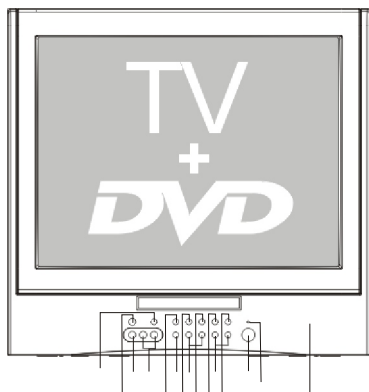

1. Remote control receiving window
2. Menu Button
3. Open / Close Button
4. Volume Button(V-)
5. Volume Button(V+)
6. DVD Play/Pause Stop Button
7. Channel Button(P-)
8. Channel Button(P+)
9. DVD Fast reverse / Fast forward
10. TV / DVD Button
11. Indicator
12. Main power switch
13. Video in

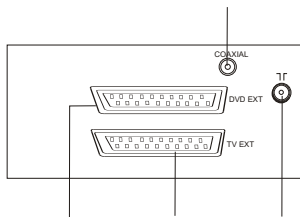

Scart Connector(DVD output)

Scart Connector(TV input and output)

AV SOCKET INFORMATION

1. Front AV: AV1 signal input in TV mode.
2. Scart Connector(TV input and output): in TV mode, containing one AV2 signal input, one RGB signal input and one AV output.
3. Scart Connector(DVD output): in DVD mode, containing one AV (CVBS) output.
4. Coaxial: in DVD mode, coaxial signal (digital and audio) output.

Buttons on the remote control

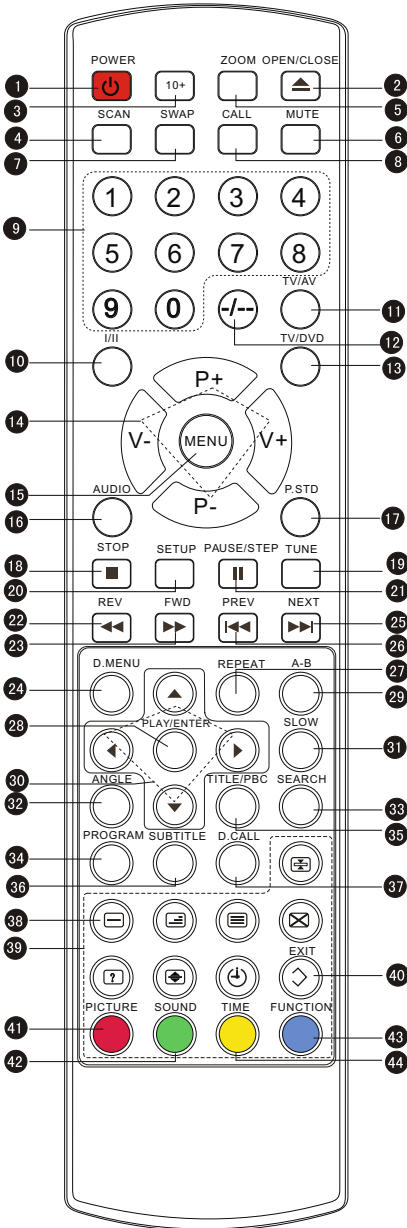

- 1 Stand By
- 2 DVD Open/close
- 3 DVD 10+
- 4 Scan
- 5 Zoom
- 6 Mute
- 7 Former Program
- 8 Call Screen Display
- 9 Program Number
- 10 Nicam / A2
- 11 TV/AV Exchange
- 12 Digital Selector
- 13 TV/DVD
- 14 Volume/Channel Selection
- 15 MENU
- 16 DVD Audio
- 17 Picture Mode
- 18 DVD STOP
- 19 Tune Menu Button
- 20 DVD SETUP
- 21 DVD PAUSE/STEP
- 22 DVD FAST REVERSE
- 23 DVD FAST FORWARD
- 24 DVD MENU
- 25 DVD NEXT
- 26 DVD PREVIOUS
- 27 DVD REPEAT
- 28 DVD PLAY/ENTER
- 29 DVD A-B REPEAT
- 30 DVD Cursor Move button
- 31 DVD SLOW
- 32 DVD ANGLE
- 33 DVD SEARCH
- 34 DVD PROGRAM
- 35 DVD TITLE
- 36 DVD SUBTITLE
- 37 DVD CALL
- 38 (No available)
- 39 TELETEXT BUTTONS
- 40 Exit Screen Display
- 41 PICTURE MENU BUTTON (Red)
- 42 Green Button (Available when in teletext mode only)
- 43 FUNCTION MENU BUTTON (Blue)
- 44 TIME MENU BUTTON (Yellow)

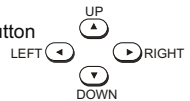

Switching on/ off the TV set

- This section explains the use of the power button and remote handset to turn your unit on and off.

Switching on/ off the TV set

Switching on/ off the TV set

1 Press the Power switch on. The power indicator will light.

2 If the indicator is "Red" press the button  on the remote control. Alternatively you can turn the TV on with P+ or P- buttons, if the "Child lock" is not set .

Note:

1 To turn the set off to "Standby " press  button on the remote control.



4
AUTO
I

2 To turn off the TV fully, press the Power button and release.

Auto switch-off function

Should the signal input from the aerial be interrupted for more than 5 minutes, the TV will automatically switch to "Standby".

If the Tv is in A/V mode or the "background" is set to off (see page 18), the set will not switch to standby.

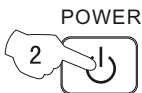

Searching channels

(Continued)

Programme skip

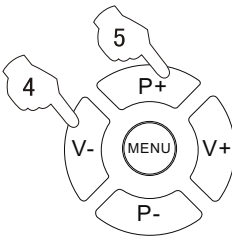
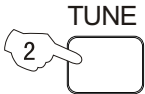
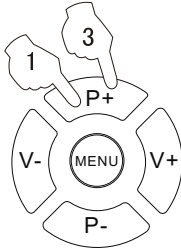

Programme skip

During "Auto tune" some channels may have been received which are of poor quality, noisy or ghosting. These can be removed with "Program Skip".

1 Press the P+/- buttons or PROGRAM NUMBER (0-9) button to choose desired channels (I.E. channel 1) .

```
1
AUTO
|
```

2 Press the TUNE button, the TUNE menu shown on the right display on the screen.

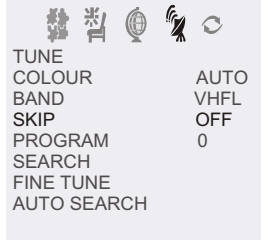

3 Press the P+/- buttons to select "SKIP".

4 Press the V-/+ buttons to turn the SKIP function "ON".

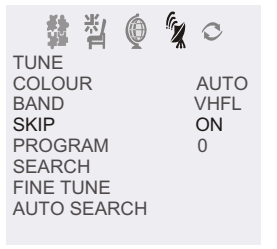

5 Press the TUNE button to close the menu. When you use the P+/- buttons to select channel, this channel will be skipped. However, you can still use the PROGRAM NUMBER buttons to select the skipped channel numbers.

If you want to recover the skipped channel

- 1 Use the PROGRAM NUMBER buttons to select the channel number to be recovered.
- 2 Repeat those steps just now.
- 3 Press the V-/+ buttons to turn the SKIP function "OFF".

Watching TV program

How to select a TV programme

Select the desired program

1 Using "Program number" buttons

- Directly enter the channel number with the numeric keypad on the remote control.
- To select channel numbers from 10 ~ 99 press [-/-] button and enter the two digit channel number
- To select channel numbers from 100 ~ 218 press [-/-] button twice and enter the 3 digit channel number

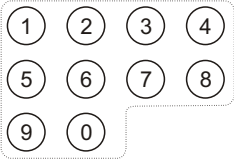

2 Using the P+/- buttons

- Press the P+ button to increase channel number.
- Press the P- button to decrease channel number.

Adjust the Volume level

Press the V-/+ buttons on the remote or the front of the TV set to adjust the volume level. The range is 0~100. When the volume buttons are pressed the volume level is displayed automatically on the TV screen.

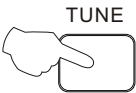
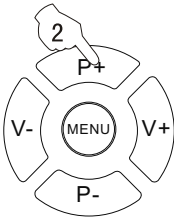

Press the TUNE button, the TUNE menu shown on the right display on the screen.

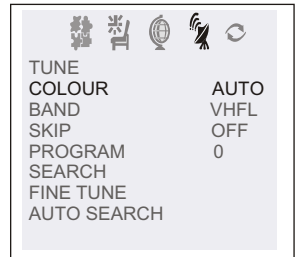

- If the picture colour is incorrect
This may be due to the TV being set to the incorrect standard. Use P+ or P- to select Colour then the V+ /V- buttons to change between Auto, PAL, NTSC and NTSC443. Press the EXIT button to save the setting.

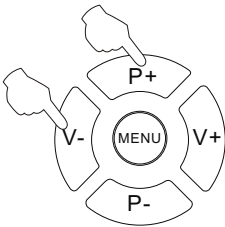

Watching TV (continued)

- !Swap function enables quick swap to the last watched program.
- Auto scan function enables automatic successive scanning of all the programs in

Program swap and auto scan functions

Program swap

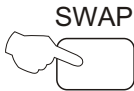

1 Suppose the channel number you used just now is 8 and the channel number you are using is 18 (as shown in the figure).

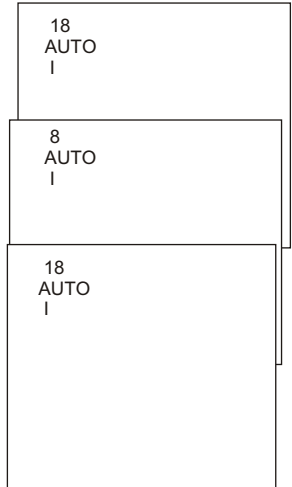

2 If you want to return to the last watched program channel 8, you can simply press the SWAP button.

3 If you want to return to channel 18, press the button again. Through this function, you can easily change between the channel you are using and the channel you used last time.

Auto program scan



1 Press the SCAN button to scan through all the memorized TV channels. The scan will pause for about 2 seconds on each channel.

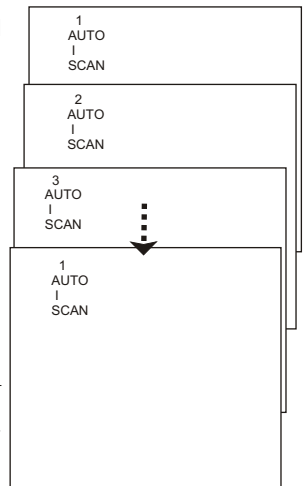

2 If you want to stop the function during auto scanning, simply press the SCAN button again.

Convenient picture and sound control functions

Multiple picture modes

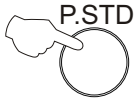

How to select picture modes

You can quickly select the desired picture mode from four preset modes and one customized mode.

Press the P.STD button to select the desired picture quality. Five kinds of picture modes (i.e., "STANDARD", "RICH", "USER", "LISTEN", "SOFT") can be selected in turn.

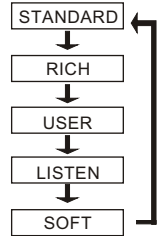

The 5 modes are

- Listen- This is a new feature that blacks out the TV screen when listening to music only channels;
- Soft- Designed for night time low light viewing;
- Standard - Designed for rooms that have good all round lighting;
- Rich- Designed for rooms with high ambient lighting such as daytime sport;
- User- A spare setting that can be adjusted to personal tastes.

PICTURE



How to customize your own picture status

1 Press the PICTURE button, the PICTURE menu shown on the right display on the screen.

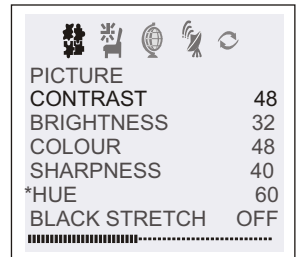

2 Press the P+/- buttons to select the item to adjusted, then press the V-/+ buttons to obtain the desired effect.

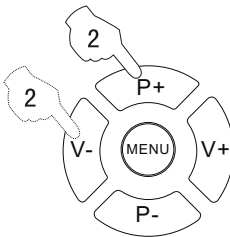

ITEM	Press V -	Press V +
CONTRAST	Weak	Strong
BRIGHTNESS	Dark	Bright
COLOUR	Shallow	Deep
SHARPNESS	Soft	Sharp
*Hue	lean to purple	lean to green

Note:

The "Hue" item only appears when the colour system is NTSC.

Convenient picture and sound control functions



(Continued)

- Black Stretch Automatically increases the contrast range
- Noise Reduce Picture Noise & Grain Reduction Circuit. (Use only on poor reception)

Black stretch and noise reduce



How to select BLACK STRETCH

1 Press the PICTURE button, the PICTURE menu shown on the right display on the screen.

	
PICTURE	
CONTRAST	48
BRIGHTNESS	32
COLOUR	48
SHARPNESS	40
*HUE	60
BLACK STRETCH	OFF
	

2 Press the P+/- buttons to select "BLACK STRETCH".

3 Press the V-/+ buttons to turn the BLACK STRETCH function "ON" or "OFF".

	
PICTURE	
CONTRAST	48
BRIGHTNESS	32
COLOUR	48
SHARPNESS	40
*HUE	60
BLACK STRETCH	ON
	

How to select NOISE REDUCE

1 Press the FUNCTION button, the FUNCTION menu shown on the right display on the screen.

	
FUNCTION	
BACKGROUND	ON
NOISE REDUCE	ON
FADE	ON
CHILD LOCK	OFF
AVL	ON
CALENDAR	ON

2 Press the P+/- buttons to select "NOISE REDUCE".

3 Press the V-/+ buttons to turn the NOISE REDUCE function "ON" or "OFF".

	
FUNCTION	
BACKGROUND	ON
NOISE REDUCE	OFF
FADE	ON
CHILD LOCK	OFF
AVL	ON
CALENDAR	ON

PICTURE

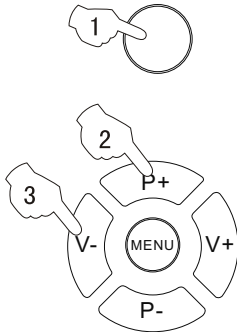

FUNCTION

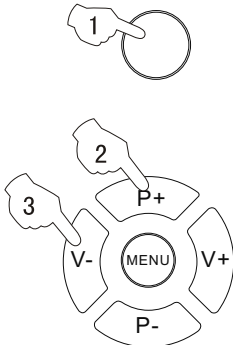

(Continued)

Mute

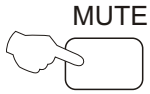

Sound mute

1 Press the MUTE button on the remote control to turn off the sound. MUTE will appear on the top left of the display.

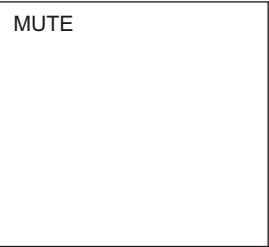

2 Press MUTE again to turn the sound back on.

Clock setting and timer on/off functions

Clock setting

The clock will only work if the TV set is left turned on or in standby. When the set is disconnected from the power supply or is turned off by the main power on the front panel, the clock loses power and will need to be reset when the power is reconnected.

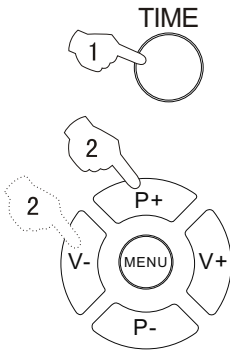

1 Press the TIME button, and the TIME menu display on the screen.

2 Press the P+/- buttons select "CLOCK", then press the V-/+ buttons to adjust the time in hour position; press again the P+/- buttons to select the time in minute position, then press the V-/+ buttons to adjust the value of minutes .

TIME	
CLOCK	17:18
ON TIME	18:00
ON PROG	1
OFF TIME	--:--
SLEEP TIMER	0
REMIND TIME	--:--
REMIND PROG	1

On/off timer

Using on/off timer function, the TV set can automatically turn on to a preset program or shut down in a preset time.

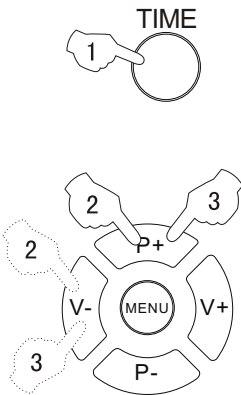

1 Press the TIME button to call up the TIME menu on the screen.

2 Press the P+/- buttons to select "ON TIME", then press the V-/+ buttons to set the value in hour position; press again the P+/- buttons to select the minute position and set the value of the minute. (take 18:00 as an example)

TIME	
CLOCK	17:18
ON TIME	18:00
ON PROG	1
OFF TIME	--:--
SLEEP TIMER	0
REMIND TIME	--:--
REMIND PROG	1

3 Press the P+/- buttons to select "ON PROG", then press the V-/+ or program direct number buttons to select your desired channel (take 8 as an example).

4 Repeat step 1-2 to set OFF TIME. (take 23:00 as an example)

TIME	
CLOCK	17:18
ON TIME	18:00
ON PROG	8
OFF TIME	23:00
SLEEP TIMER	0
REMIND TIME	--:--
REMIND PROG	1

Sleep timer and program preset

Sleep timer

The TV has 18 option settings for "Sleep timer", each setting has a time value of 10 minutes.

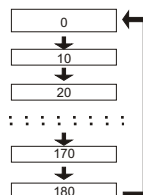

TIME



1 Press the TIME button, and the TIME menu display on the screen.

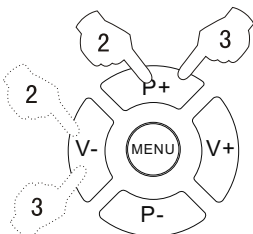

2 Press the P+/- buttons to select "SLEEP TIMER".

3 Press the V -/+ buttons to set the value of the SLEEP TIMER.

TIME				
CLOCK				17:18
ON TIME				18:00
ON PROG				8
OFF TIME				23:00
SLEEP TIMER				120
REMIND TIME				--:--
REMIND PROG				1

REMIND PROG function

Program remind timer, that displays an on-screen reminder prompt, when a program on a different channel is due to start.

1 Press the TIME button to call up the TIME menu on the screen.

2 Press the P+/- buttons to select "REMIND TIME", then press the V -/+ buttons to set the value in hour position; press again the P+/- buttons to select the minute position, and then set the value of the minute. (take 19:00 as an example)

3. Press the P+/- buttons to select "REMIND PROG", then press the V -/+ buttons or the program direct number buttons to set the desired channel (take 18 as an example).

TIME				
CLOCK				17:18
ON TIME				18:00
ON PROG				8
OFF TIME				23:00
SLEEP TIMER				120
REMIND TIME				19:00
REMIND PROG				1

TIME

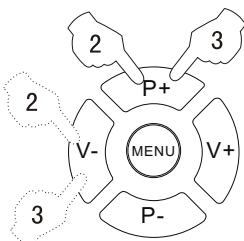

NOTE: For REMIND PROG to operate CHILD LOCK must be turned off.

TIME				
CLOCK				17:18
ON TIME				18:00
ON PROG				8
OFF TIME				23:00
SLEEP TIMER				120
REMIND TIME				19:00
REMIND PROG				18

Screen saver and childlock functions

How to select "Screen saver" function

When the "Background" function is ON a bouncing "No Signal" logo will be displayed on a blue background.

NO SIGNAL

FUNCTION



1 Press the Function button, the Function menu will be displayed on the right of the screen.

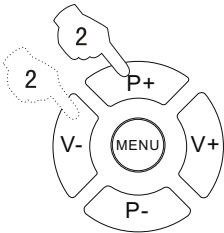

2 Press the P+/- buttons to select "BACKGROUND" and press the V-/+ buttons to turn the BACKGROUND function "ON".

FUNCTION	BACKGROUND	NOISE REDUCE	FADE	CHILD LOCK	AVL	CALENDAR	ON	OFF	ON	OFF	ON

Child lock function

Enables the TV front control buttons to be locked.

1 Press the Function button, the Function menu will be displayed on the right of the screen.

FUNCTION



2 Press the P+/- buttons to select "CHILD LOCK" and press the V-/+ buttons to turn CHILD LOCK function "ON".

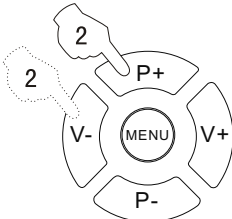

FUNCTION	BACKGROUND	NOISE REDUCE	FADE	CHILD LOCK	AVL	CALENDAR	ON	OFF	ON	ON	ON

NOTE:

All the control panel buttons on the front of the TV are disabled when CHILD LOCK is turned on. The power switch will still turn the TV set off.

Setup function

(Continued)

AVL and calendar functions

AVL function

Automatic Volume Limit Control reduces the effect of large volume changes. For instance, when advertisements come on.

1 Press the Function button, the Function menu will be displayed on the right of the screen.

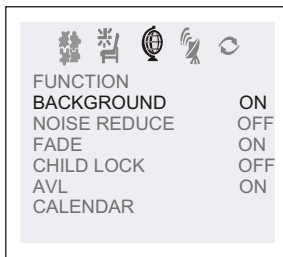

2 Press the P+/- buttons to select "AVL" .

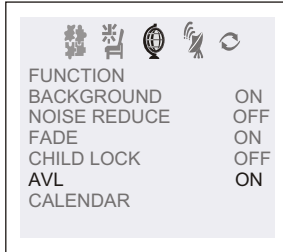

3 Press V-/+ buttons to turn the AVL function "ON" or "OFF".

FUNCTION

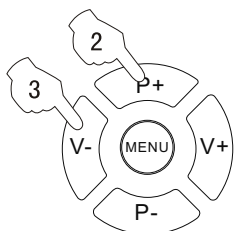

Calendar function

Enables the TV sets internal calendar to be set.

1 Press the Function button, the Function menu will be displayed on the right of the screen.

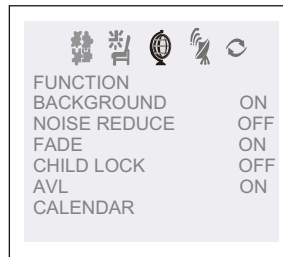

2 Press the P+/- buttons to select "CALENDAR", then press the V-/+ buttons to the CALENDAR display on the screen.



3 Press the P+/- buttons to turn the YEAR/MONTH/DAY, press V-/+ buttons to set or adjust the YEAR/MONTH/DAY.

FUNCTION

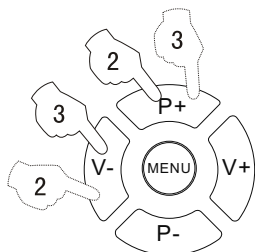

Exchange

Exchange

This feature enables TV programs that may be on a wrong TV channel number to be swapped/exchanged. This feature is very useful when Automatic Search Tuning has been used, to reallocate the found programs to the correct channel numbers.

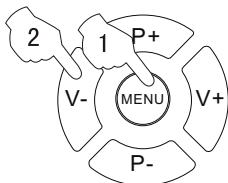

1 Press the Menu button until the "Exchange" menu is displayed on the screen.



2 Press the V-/+ buttons or the PROGRAM NUMBER (0-9) buttons to set PROGRAM 1 TO 6.

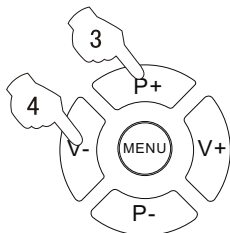

3 Press the P+/- buttons to select "PROGRAM 2".

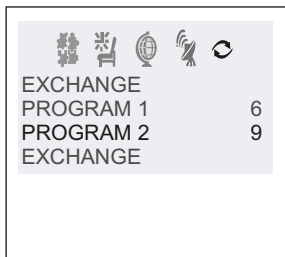

4 Press the V-/+ buttons or the PROGRAM NUMBER (0-9) buttons to set PROGRAM 2 TO 9.

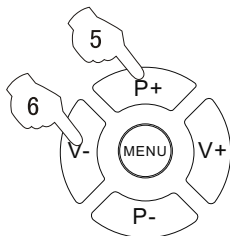

5 Press the P+/- buttons to select "EXCHANGE".



6 Press the V-/+ buttons to set "EXCHANGE".

Teletext

- Teletext is an information system, broadcast by certain channels, which can be read like a newspaper . It also provides subtitles for people with hearing difficulties or those who are unfamiliar with the language in which a particular program is being broadcast (cable networks, satellite channels, etc.). Teletext button on remote can be used in TV mode only. When using DVD or selecting AV1 /AV2, please do not press the text button.

Teletext

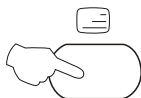
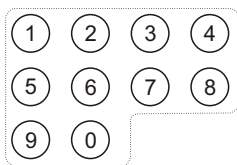
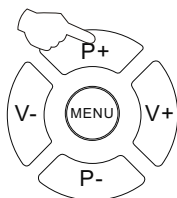

Teletext functions

To select "Teletext" press the Teletext button on the handset. To switch off Teletext, press the button again. "Note all menu functions are not available in Teletext mode". Only a few direct button control functions are available in TELETEXT mode, they are:

- Volume adjustment, but without OSD display.
- Mute function, but without OSD display.

Page up/down

Use the P+/- buttons to browse next or previous page.

Page number entering

To select a Teletext page, enter the page number using the numeric key pad on the remote control, or use the P+ or P- buttons, or the coloured Fast text buttons.

Mix mode

To view the TV picture while in Text mode press the  button, this will superimpose the Teletext data on top of the Tv picture. Press this button again to return to Full text.

Teletext



Cancel mode

This feature allows the TV picture to be displayed while next page to be searched is entered and found. Only the top teletext line is displayed until the page is found. Press the button to hide the teletext information. Either press the  button or the Text button to exit the cancel display mode.

Language change

Pressing the  button will change the Teletext characters between Eastern and Western.

Hold

Pressing the  button will stop the teletext page automatically updating. This feature is very useful where there are several teletext pages or data on the same page number.

Size

Pressing the  button changes between full screen top half bottom half full screen. This feature is very useful as it magnifies the image making the characters easier to read.

Reveal

Pressing the  button will reveal hidden text. This feature is used to reveal information such as answers to Teletext on-line interactive puzzles.

Subcode / Time

By entering its 4-digit number to enter a secondary page; While in normal TV mode only, pressing the button  will display the teletext time in the top right hand corner for a few seconds.

Switch teletext on/off

Press the  button on the remote control to turn teletext On/Off.

Fast text coloured buttons

Fast text automatically displays the four most commonly used pages that the broadcaster thinks that you may want to choose next. Press the same coloured button on the remote control as the coloured link at the bottom of the teletext page to go directly to that page.

Basic Playback

Preparations

- Press the TV/DVD button on the remote control or the TV to enter the DVD status.

Basic playback

1. Press OPEN/CLOSE to open the disc tray, place a disc on the disc tray.
There are two different disc sizes. Place the disc in the correct guide on the disc tray. If the disc is out of the guide, it may damage the disc and cause the DVD player to malfunction.
 - Do not place a disc which is unplayable in this DVD player.
2. Press OPEN/CLOSE to close the disc tray, the playback will automatically start.
 - Some discs do not start automatically. Press PLAY/ENTER to start playback.
3. Some discs may start playback with a menu. Use the cursor buttons on the remote control to select menu options and press PLAY/ENTER to start. You may also press the digit buttons to select a menu option directly. Many DVDs will not allow this during start-up.

Pause playback

1. Press PAUSE/STEP to pause playback (still mode).
The sound will be muted during still mode.
2. Press PLAY/ENTER to resume normal playback.

Stop playback

1. Press STOP ■ button to stop the disc playing. With some discs the player will memorize the stop position, such as DVD's and audio CD's.
2. Press PLAY/ENTER to playback to resume playback from the location where playback is stopped or from the beginning of the disc.
3. Press STOP twice to stop completely.

Previous and Next

During Playing, pressing the PREVI◀◀ key will restart the current chapter and skip chapters backwards with each subsequent press until the start of the disc is reached.
Each press of NEXT ▶▶ key during playing will skip the current chapter and play the next one.

Fast forward and Fast reverse

1. Press FWD ▶▶ to fast forward through the disc.
Each time the FWD ▶▶ button is pressed, the fast forward motion speed changes.
2. Press PLAY/ENTER to resume normal playback.
3. Press REV ◀◀ to fast reverse through the disc.
Each time the REV ◀◀ button is pressed, the fast reverse motion speed changes.
4. Press PLAY/ENTER to resume normal playback.

Single step playback

To "single step" press the "Pause" button, then press "Pause/Step" in continuous steps to view the next frame.

Advanced Playback

Advanced Playback

IMPORTANT NOTE:

ALL DESCRIBED FUNCTIONS ARE FOR DVD DISCS. IF YOU PLAY OTHER FORMATS, THE OPERATION AND DISPLAY ON SCREEN MAY VARY.

SBUTITLE

Press " SUBTITLLE ", the screen will display "SUBTITLE 01/XX XXXXX", "01" indicates the ordinal number of this language; "XX" indicates total number of language; "XXXXXX" indicates the language of country. (the number of language depends on disc). This function can select up to 32 languages displayed on screen.

REPEAT

Press " REPEAT " and Chapter repeat will be displayed on screen, the second press will display Title repeat, the third press will display All repeat, the fourth press will cancel this function.

A-B

Press " A-B " to begin start-point, press again to set an end point and complete setting. The selected section A-B will be repeated. The third press will cancel this function.

ANGLE

When enjoying sports, concert or theatre, press this key to watch same actions in different angles. (Valid for discs possessing this function. Using a disc recorded in multi-angle you can view the scene from different angles,for example,front, side, whole view and exterior scene).

D.MENU

Press this key to display root menu,select item according to your preference. (This function will work with a DVD having a multi-layer menu.)

D.CALL

Pressing this key will cycle through "title elapsed", "title remain", "chapter elapsed", "chapter remain" and "display off". Each displays the appropriate time information.

PROGRAM

When playing discs, press "PROGRAM" to enter program mode. Starting with program number "01" highlighted, press the digit buttons to select the title and chapter number that you want. When finished move the cursor to select "START". This will start the program playback.

SEARCH

Press " SEARCH " once to display Disc Go To --:--, use numeric key to enter the desired time of Disc. Press " SEARCH " twice to display Track Go To -:--, use numeric keys to enter the desired time of track. Press " SEARCH " 3 times to display Select Track --/03, use numeric keys to enter the desired track.

SLOW

Press SLOW to play a disc in slow forward. Each time the SLOW button is pressed, the slow motion speed changes. Press PLAY/ENTER to resume normal playback;

Note: This function is invalid for CD and MP3.

TITLE/PBC

With some DVD discs pressing this key will display the title menu. You can then use the digit buttons to select the item you prefer.

AUDIO

Press this key can change the mode of audio. such as: Audio 1/2: AC 3 2 CH English
Audio 2/2: AC 3 5.1 CH English
Press this button to cycle between Mono Left, Mono Right, Mix-Mono and Stereo.

Note: Do not press this button continuously. Each press must have a 3 second delay.

Special Function Playback

JPEG DISC PLAYBACK

When a disc containing standard JPEG picture files is inserted into the player, a navigation menu will be displayed automatically. Use the UP and DOWN cursor buttons to select a file then press PLAY/ENTER. The slide show will commence. Press PREVIOUS or NEXT to move between pictures. Press pause to stop on the current picture. Press PLAY/ENTER to resume normal playing.

MP3 PLAYBACK

When playing an MP3 disc, a navigation menu will be displayed automatically. In the menu, use UP or DOWN cursor buttons to choose the folder, then press PLAY/ENTER to enter the folder. Use the UP and DOWN cursor buttons to select the file and press PLAY/ENTER. Pressing the LEFT cursor button will take you to the previous screen/menu.

SCREEN SAVER FUNCTION

This unit employs a screen saver mode to help protect the tube during static video pictures. This can be turned off on the GENERAL SETUP PAGE (see Pg. 28)

DVD System Setup

DVD System Setup

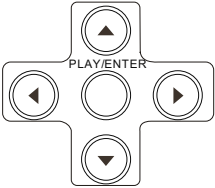
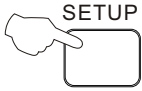

General Setup Process

1. Press the SETUP button, the General Setup Page, Preference Page will be displayed in turn.
2. Press ▲ or ▼ to select the item, then press ► to enter the submenu.
3. Press ▲ or ▼ to setup, then press PLAY/ENTER to confirm.
4. Press SETUP button to exit the menu.

..General Setup Page..			
TV Display	LB	4	3:Ps
Angle Mark	On	4	3:Lb
OSD Lang	ENG	16	9
Spdif Output			
Caption	On		

..Preference Page..			
TV Type	Auto	PAL	AUTO
Parental			NTSC
Password			
Default			

General Setup Page

ASPECT RATIO DESCRIPTION

When using the DVD with the internal TV, select 4: 3/LB.

The following information applies only when the DVD output is connected to an external TV.

..General Setup Page..			
TV Display	LB	4	3:Ps
Angle Mark	On	4	3:Lb
OSD Lang	ENG	16	9
Spdif Output			
Caption	On		
Screen Saver	Off		

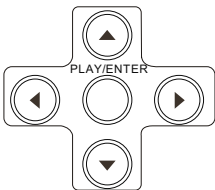

- 4: 3/PS (PS = Pan and Scan)
You may select if you have a normal aspect ratio (4:3) TV, although the 4:3/LB (letter box) is a more common choice. In PS mode, widescreen material will fill the screen, but at the expense of chopping off extreme left and right edges of the original film picture. For this feature to work, the disc must be specially coded. Such discs are uncommon.
- 4: 3/LB (LB = Letter Box)
You may select this if you have a normal aspect ratio (4:3) TV. Widescreen material will be shown in pure unaltered form, allowing the entire picture area of the original film to be viewed without any side cropping. Black bars will appear above and below the picture.
- 16: 9
You may select this if you have a widescreen (16:9) TV. Black bars may still appear above and below the picture even if using a widescreen TV. This is because some film directors prefer to use ultra widescreen aspect ratios e.g. 2.35:1. This will normally be indicated on the DVD packaging.

DVD System Setup(Continued)

DVD System Setup

General Setup Page

ANGLE MARK: Users can select a particular camera angle when playing a DVD which offers multiple angles.

This item allows you to set Angle Mark ON or OFF.

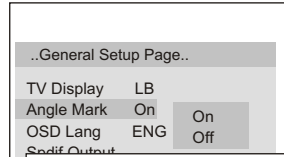

On Screen Display (OSD) Language: Users can select on-screen display language.

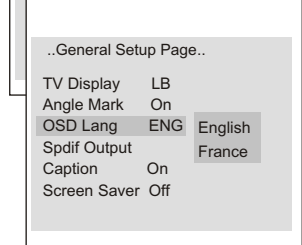

SPDIF OUTPUT MODE: Sets the audio outputs.

This DVD player includes three kinds of audio output:

1. **SPDIF OFF:** An analog surround sound format is output through the back-panel connections for 2-CH audio out or 5.1 CH audio out.
2. **SPDIF/RAW or SPDIF/PCM:** This surround sound format is output to a Dolby Digital/DTS decoder through the coaxial connector on the back panel of the product.

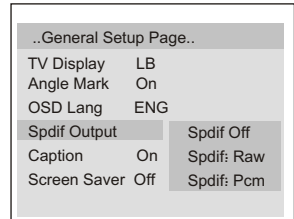

CAPTIONS: This function allows you to display or hide the caption.

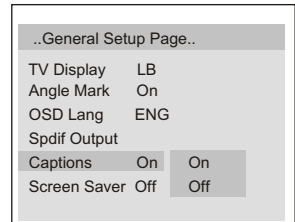

SCREEN SAVER: If the screen saver is on, then there will be an animated picture of DVD on the screen whenever the DVD player is idle for more than 3 minutes .

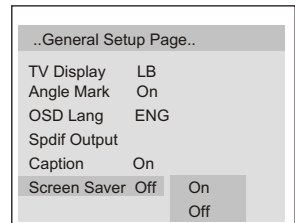

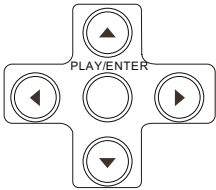
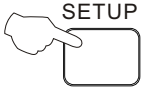

Preference Page

The Preference Page is only available when there is no disc in the player. These settings are applied consistently to all discs which are inserted and played.

TV TYPE: This player supports different TV output, including MULTI(Auto), NTSC, and PAL systems. Usually please set to MULTI.

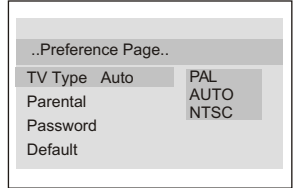

PARENTAL: The parental control function works in conjunction with the different censorship classes assigned to DVDs. These classes help to control the types of DVDs that the family watches. There are up to 8 censorship classes for DVDs.

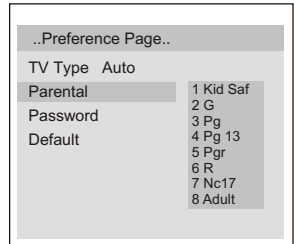

Note:

- 1 To change this setting you must enter your password. (Initial password is 1234)
- 2 When set to OFF, all discs may be viewed.

PASSWORD CHANGE:

You can change your password by entering 4 digits. You must confirm the 4 digits before the new password can be accepted.

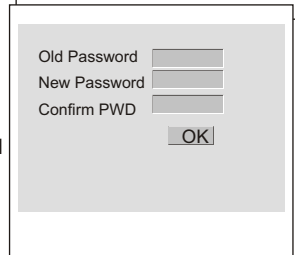
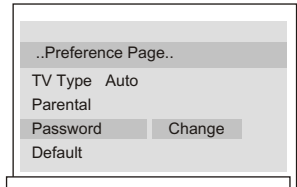

NOTE: If you forget your password or a password is accidentally set enter 1369 as the password. This will enable you to regain control.

DVD System Setup(Continued)

DVD System Setup

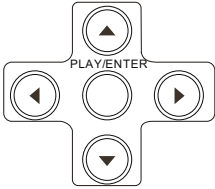
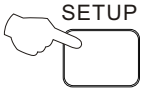

DEFAULT: Resets all settings (except password and parental lock status) for this DVD player back to the manufacturers original settings. Press ENTER to perform the reset.

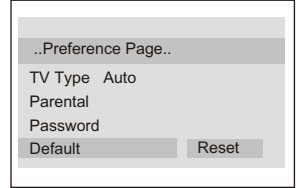









Note:

Some functions may not be available depending on the type of disc.

Playable Discs

The following discs can be played:

DISCS	LABEL	CONTENTS	DIMENSION
DVD VIDEO		Audio +Video (moving picture)	12cm
			8cm
AUDIO CD		Audio	12cm
			8cm
HDCD		Audio	12cm
			8cm
MP3		Audio	12cm
			8cm
JPEG		Video(picture)	12cm
			8cm
KODAK CD		Video(picture)	12cm
			8cm
CD-R		Audio or Video (moving picture)	12cm
			8cm
CD-RW		Audio or Video (moving picture)	12cm
			8cm
CD+G		Audio(picture)	12cm
			8cm

- You cannot play discs other than those listed above.
- You cannot play discs of non-standardized discs, even if they may be labelled as above.
- The performance of CD-R or CD-RW disc is depend on the way of disc-burning. In a few cases, their performance may be not very well or even no performance.

Disc Protection and DVD Characteristics

ON HANDLING DISCS

- Do not touch the playback side of the disc.
- Do not attach paper or tape to disc.

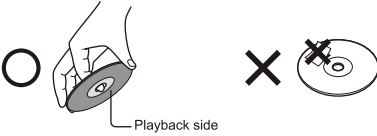

ON CLEANING DISCS

- Fingerprints and dust on the disc cause picture and sound deterioration. Wipe the disc from the centre outwards with a soft cloth. Always keep the disc clean.



- If you can not wipe off the dust with a soft cloth, wipe the disc lightly with a slightly moistened soft cloth and finish with a dry cloth.
- Do not use any type of solvent such as thinner, benzene, commercially available cleaners or anti-static spray for vinyl Lps. It may damage the disc.

ON STORING DISCS

- Do not store discs in a place subject to direct sunlight or near heat source.
- Do not store discs in place subject to moisture and dust such as a bathroom or near a humidifier.
- Store discs vertically in a case. Stacking or placing object on discs outside of their case may cause warping.

STRUCTURE OF DISC CONTENTS

Normally, DVD discs are divided into titles, and the titles are sub-divided into chapters. Audio CD are divided into tracks.

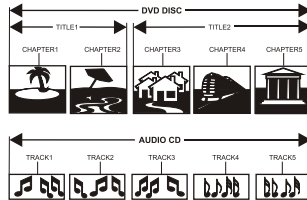

Each title, chapter, or track is assigned a number, which is called title number, chapter number or track number respectively.

There may be discs that do not have these number.

Compare DVD disc with other discs:

	DVD				LD	SVCD	VCD	CD
Encode method	Digital/MPEG II				Analog	Digital	Digital/MPEG I	Digital
Capacity	Single-side single-layer 4.7G	Double-side single-layer 8.5G	Single-side double-layer 9.4G	Double-side double-layer 17G	Single-side 60 minutes double-side 120 minutes	650MB	650MB	650MB
Playing Time	133 minutes	242 minutes	266 minutes	484 minutes		45 minutes	74 minutes	74 minutes
Disc diameter	12cm/8cm				30cm/20cm	12cm	12cm	12cm/8cm
Horizontal resolution	More than 500 line				No more than 430 line	No more than 350 line	No more than 250 line	
Picture proportion	Multiple kinds				One kind	One kind	One kind	
Subtitle	32 kinds				16 kinds at most	4 kinds		
Language	8 kinds				4 kinds at most	4 kinds at most	2 kinds	2 kinds
Sound quality	48KHz, 96KHz/ 6, 20, 24bit				44.1KHz/ 16bit	44.1KHz/ 16bit	44.1KHz/ 16bit	44.1KHz/ 16bit

Connecting to the other video and audio equipment

- You can attach other equipment such as another TV or other audio amplification equipment to the scart/digital coaxial sockets at the rear of the set to enjoy higher quality sound and picture.

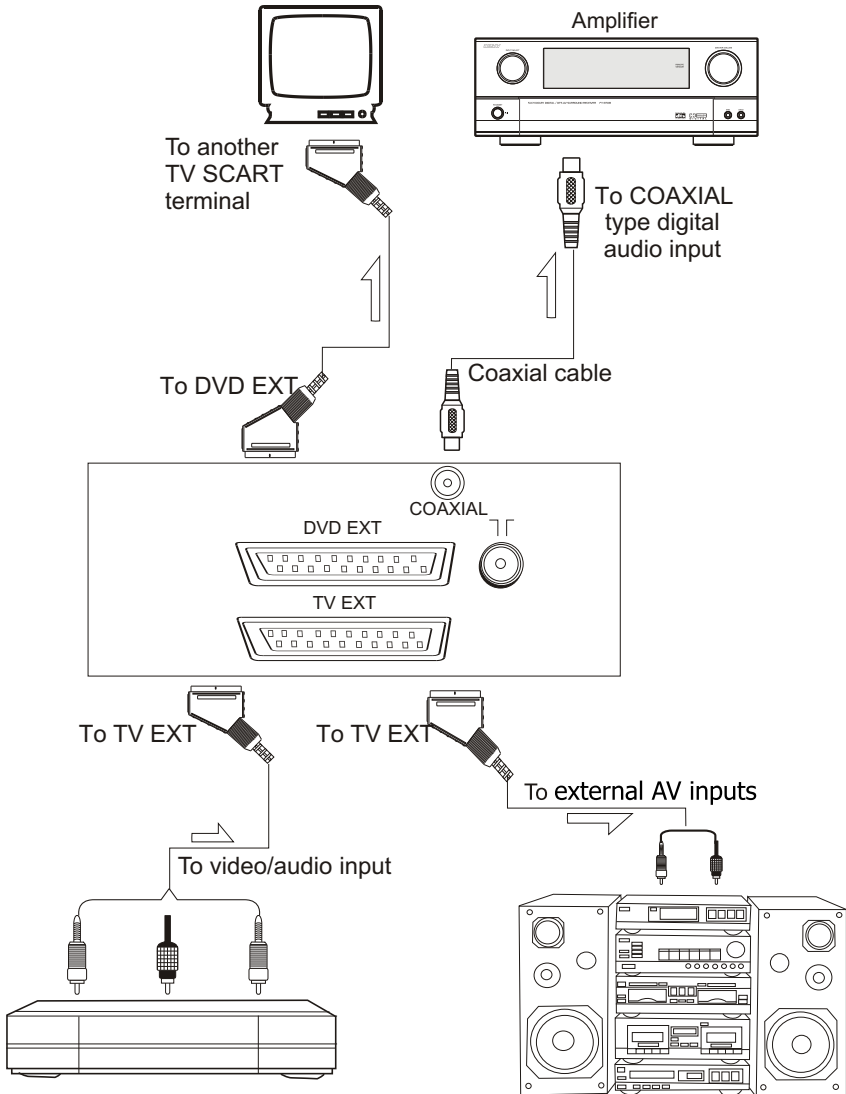

DVD, VCD and other reproducing equipment

Stereo

Trouble shooting guide

- Before calling the "Help" line please make these preliminary tests.

Symptom	Fault	Remedy
Screen not lit, Led is Red	Set still in standby.	Press P+ or P- on handset. TV may be in "Child lock".
Screen not lit, Led is Green.	Brightness may be turned down.	Press "Picture" button on handset. Adjust brightness level.
Screen lit, Noisy or no picture.	No or low signal.	Check aerial connection. Aerial may be damaged.
Screen lit. No noise.	Set in AV mode	Switch set to TV Mode
No colour.	Colour turned down	Adjust colour settings.
Picture Ok. No sound.	Sound muted.	Switch sound mute "Off"
One sound channel missing.	Balance incorrectly set.	Adjust sound "Balance"
DVD not playing. No disc on screen.	Disc in wrong way round. Disc or Laser dirty.	Place disc with label facing upwards. Clean disc carefully. Use special laser cleaning disc.
DVD picture skips and jumps.	Dirty disc.	Clean disc carefully.

Specifications

- The specifications offered you here are only for reference and, with the improvement of the products ,there may be some different between the description and the practicality.

Specifications

Model	GTV51N16DVD
Colour system	PAL, NTSC PLAYBACK
Sound system	I
Picture tube	21"colour picture tube (51cm viewable)
Sound output power	2X2W (10% THD)
Power requirements	AC 230V~ 50Hz
Power consumption	80W
Dimension	500 (Width) x480 (Depth) x485 (Height) (mm)
Accessories	Remote control X1 Owner's manual X1 Battery(AA) X2

NOTE

Design and specifications are subject to change without notice.
Dimensions quoted in this manual are approximate.

Goodmans