



# **User's Guide**

## **Multimedia Projector**

**EB-Z10005U EB-Z10000U**

**EB-Z9875U EB-Z9870U**

**EB-Z9750U**

**EB-Z11000W**

**EB-Z9900W**

**EB-Z9800W**

**EB-Z11005 EB-Z11000**



**EB-Z9870**

# Safety Instructions





## Safety indications

The documentation and the projector use graphical symbols to show how to use the projector safely.

The indications and their meaning are as follows. Make sure you understand them properly before reading the guide.

 <b>Warning</b>	This symbol indicates information that, if ignored, could result in personal injury or even death due to incorrect handling.
 <b>Caution</b>	This symbol indicates information that, if ignored, could result in personal injury or physical damage due to incorrect handling.

## General information indications

<b>Attention</b>	Indicates contents that could cause damage or malfunction to the projector.
	Indicates additional information and points which may be useful to know regarding a topic.
	Indicates a page where detailed information regarding a topic can be found.
	Indicates that an explanation of the underlined word or words in front of this symbol appears in the glossary of terms. See the "Glossary" section of the "Appendix".  "Glossary" <a href="#">p.226</a>
[Name]	Indicates the name of the buttons on the remote control or the control panel. Example: [Esc] button
Menu Name	Indicates the Configuration menu items. Example: Select <b>Brightness</b> from <b>Image</b> . <b>Image - Brightness</b>

Make sure you read the following before you use the projector.

☛ [Safety Instructions](#)

---

## Warning and Cautions on Installation

An optional ceiling mount is required when suspending the projector from a ceiling.

☛ "Optional Accessories" p.198

### **Warning**

- Do not use or install the projector where it may be subject to water or rain, or high humidity, such as outdoors, in a bathroom, or shower room, and so on. Otherwise, it could cause a fire or electric shock.
- A special method of installation is required when suspending the projector from a ceiling (ceiling mount). If installation work is not carried out correctly, the projector could fall down. This may result in injury or accidents. Contact your local dealer or the nearest address provided in the Epson Projector Contact List.  
☛ [Epson Projector Contact List](#)
- When installing the projector on the ceiling, make sure you take measures to prevent it from falling such as passing a wire through the handles.
- If you use adhesives on the ceiling mount fixing points to prevent the screws from loosening, or if you use things such as lubricants or oils on the projector, the projector case may crack causing it to fall from its ceiling mount. This could cause an accident or injury to anyone under the ceiling mount.  
When installing or adjusting the ceiling mount, do not use adhesives to prevent the screws from loosening and do not use oils or lubricants and so on.
- Do not cover the projector's air intake vent or air exhaust vent. If either of the vents is covered, the internal temperature could rise and cause a fire.
- Do not place flammable objects in front of the lens. If you set the schedule to turn on the projector automatically, any flammable objects placed in front of the lens could cause a fire.
- Do not tie the power cord and other connection cables together. Otherwise, it could cause a fire.
- Only use the specified power-supply voltage. Otherwise, it could cause a fire or electric shock.

## Warning

- Be careful when handling the power cord. Otherwise, it could cause a fire or electric shock. Note the following when handling the power cord.
  - Do not plug multiple power cords in a single electric outlet.
  - Do not plug in the power cord if there are any foreign substances, such as dust, stuck to it.
  - Make sure you insert the power cord all the way in.
  - Do not plug in or unplug the power cord with wet hands.
  - Do not pull the cord when unplugging the power cord. Make sure you hold it by the plug.
- Do not use a damaged power cord. Otherwise, it could cause a fire or electric shock. Note the following when handling the power cord.
  - Do not alter the power cord.
  - Do not place any heavy objects on the power cord.
  - Do not bend, twist, or pull the power cord forcibly.
  - Do not layout the power cord near a heating device.
- When using the power cord in an area where the power-supply voltage is less than 120 V, make sure that the power is supplied from an outlet with more than 15 A.
- Do not share the outlet that you are using for the projector with other devices.

## Caution

Do not place the projector on an unstable surface, such as on an unstable table or tilted surface. When projecting vertically, install the projector appropriately to prevent the projector from falling.  
Otherwise it may cause an injury.

## Attention

- Do not install the projector in a location that is subject to vibration or shock.
  - Do not install the projector near a high-voltage line or object that generates magnetism. Otherwise the projector may not work correctly.
  - Do not use or store the projector in a location that is subject to extreme temperatures. Also, avoid sudden temperature changes.  
Make sure you use or store the projector in a place that is within the following operating or storage temperature ranges.
    - Operating temperature range: 0 to +50°C\* (No condensation)
    - Storage temperature range: -10 to +60°C (No condensation)
- \* At an altitude of 0 to 1,499 m, the operating temperature is 0 to +50°C when **Power Consumption** is set to **ECO** or **Temp Interlock**, and 0 to +45°C when it is set to **Normal**.  
At an altitude of 0 to 1,500 m, the operating temperature is 0 to +45°C when **Power Consumption** is set to **ECO** or **Temp Interlock**, and 0 to +40°C when it is set to **Normal**.
- When using at an altitude of 1,500 m or more, set **High Altitude Mode** to **On**.
    - ☛ **Extended - Operation - High Altitude Mode** [p.122](#)

## Attention

- When projecting with the projector tilted, do not tilt it at more than the specified angle. This may cause malfunctions or accidents to occur.

Angle of tilt (when a standard lamp is attached)

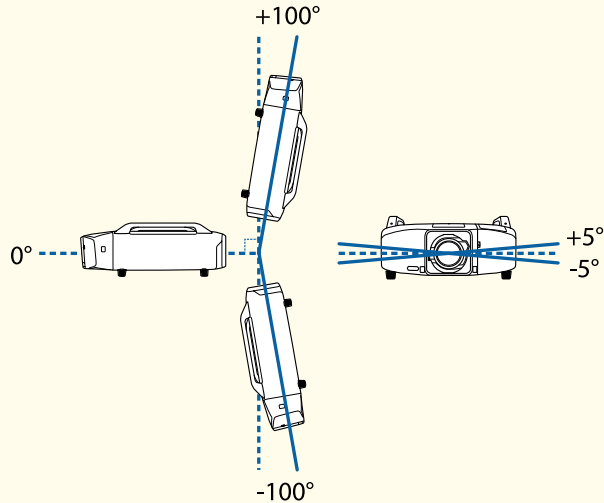

Do not use the projector upside down.

Using the projector at angles not shown in the illustrations above may damage it or cause an accident.

For the operating conditions when attaching the lamp unit (for portrait use), see the following.

☛ "Notes on portrait projection" [p.6](#)

- Once installation is complete, make sure you set the **Direction**. Otherwise the lamp's operating life may be reduced significantly.
  - ☛ "Setting the direction" [p.30](#)
- Using the projector at an improper angle or setting the Configuration menu incorrectly causes malfunctions and shortens the operating life of optical parts.

## Attention

- Make sure there is a gap at least as wide as shown in the following illustration between the wall and the air exhaust vent and the air intake vent.

Air exhaust vent

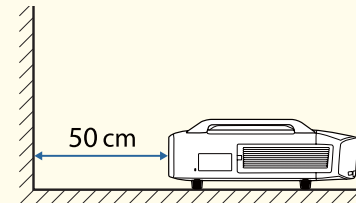

Air intake vent

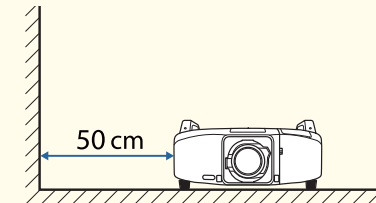

- When setting up multiple projectors, make sure there is a gap at least as wide as shown in the following illustration between the projectors. Also, make sure that the heat from the air exhaust vent does not go into the air intake vent.

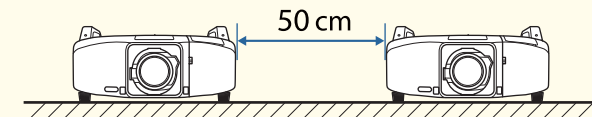

- Do not place the projector directly on top of another projector.

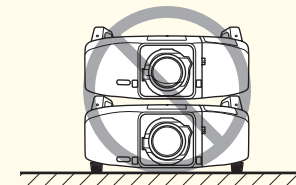

## Attention

- When installing the projector on a surface other than the floor, use the four ceiling mount fixing points to secure the projector. Never detach the handles. If you use the projector without handles, it may cause a malfunction.
- When installing the projector on the ceiling, remove the feet and attach the supplied foot covers.

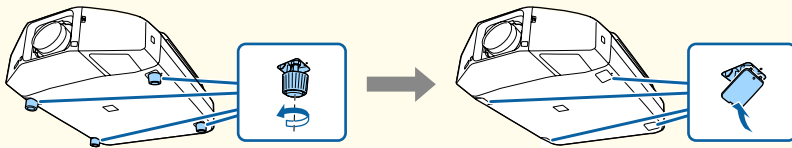

- The feet can be attached and removed. Note that the feet will detach if they are extended more than 10 mm. After removing the feet, make sure you attach the supplied foot covers.
- Do not use the screw holes for the feet to secure the projector or attach other screws, and so on. Otherwise malfunctions may occur.



- We recommend setting the focus, zoom, and lens shift at least 20 minutes after you start the projection, because images are not stable right after turning on the projector.
- When adjusting the vertical lens shift, adjust by moving the image from the bottom to the top. If it is adjusted from the top to the bottom, the image position may move down slightly after adjusting.

## Notes on portrait projection

An optional frame is required for portrait projection.

☛ "Optional Accessories" p.198

## Attention

- When performing portrait projection, attach lamp units (for portrait use) on both Lamp 1 and Lamp 2. If dedicated lamps are not used, the projector does not cool down correctly, and it may cause a malfunction. ☛ "Optional Accessories" p.198
- Make sure you install the projector with the air intake vent facing down. If the air intake vent is facing up, the projector does not cool down correctly, and it may cause a malfunction.

### Angle of tilt

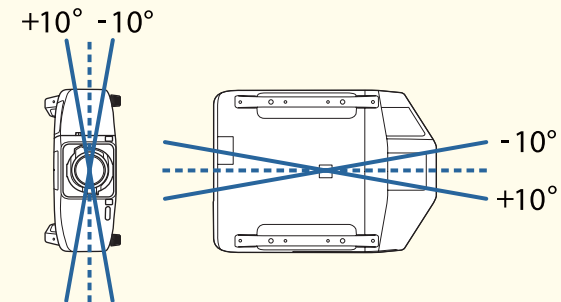

Using the projector at angles not shown in the illustrations above may damage it or cause an accident.

- Make sure that you install the projector with the air intake vent facing down and that there is a gap at least as wide as shown in the following illustration between the projector and the floor and so on.

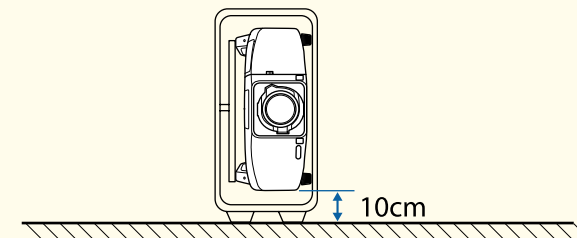



- You cannot rotate the display direction for the menu, message, and so on.
- When performing portrait projection, you do not need to set the **Direction**.
- **Power Consumption** is disabled.  
☛ **Settings - Power Consumption** [p.121](#)

## Warning and Cautions on Usage



### Warning

- Do not cover the projector's air intake vent or air exhaust vent. If either of the vents is covered, the internal temperature could rise and cause a fire.
- Do not look into the lens while projecting.



### Caution

Do not place objects that may become warped or otherwise affected by heat near the air exhaust vent and do not put your face or hands near the vent while projection is in progress.

### Attention

- Do not repeatedly turn off the power and immediately back on. Turning the power on and off frequently may shorten the lamp's operating life.
- Only remove the lens unit when necessary. If dust or dirt enters the projector, projection quality deteriorates or it could cause a malfunction.
- Try not to touch the lens section with your hand or fingers. If fingerprints or oils are left on the surface of the lens, projection quality deteriorates.
- Store the projector with the lens unit attached.  
If the projector is stored without the lens unit, dust and dirt may get inside the projector and cause malfunctions or lower the quality of projection.
- Do not store the projector with the front side facing up.
- When storing, make sure you remove the batteries from the remote control. If the batteries are left in the remote control for an extended period of time, they may leak.

## Notes on Transporting

There are many glass parts and precision components inside the projector. To prevent damage due to impacts when transporting, handle the projector as follows.



### Caution

The projector should not be carried by one person. Two people are needed to unpack or carry the projector.

### Attention

- When Moving Nearby
  - Turn off the power to the projector and disconnect all cables.
  - Attach the cover to the lens.
  
- When Transporting

After checking the points in "When Moving Nearby", prepare the following and then pack up the projector.

  - Retract the feet for storing.
  - Remove the lens unit if an optional lens, other than the standard zoom lens, is attached.  
Attach the standard zoom lens if the projector has a built-in lens. If the projector does not have a lens, attach the cover that was on the lens mount when you purchased the projector.
  - The vertical and horizontal lens shifts are positioned in the center.
  - Enclose the projector securely in packaging material to protect it from shock, and place it into a strong cardboard container. Be sure to notify the carrier company that it is precision equipment.



## Safety Instructions ..... 2

## Introduction

---

### Part Names and Functions ..... 14

Front/Top .....	14
Rear .....	15
Base .....	16
Interface .....	16
Control panel .....	18
Remote Control .....	20
Replacing the remote control batteries .....	23
Remote control operating range .....	24

## Preparing the Projector

---

### Installing the Projector ..... 26

Attaching the Projector Lens Unit .....	26
Attaching .....	26
Removing .....	27
Attaching and Removing the Interface Cover .....	28
Removing .....	28
Attaching .....	29
Installation Settings .....	30
Setting the direction .....	30
Changing the direction of the image (Projection) .....	31
Selecting the lamp .....	31
Screen Settings .....	32
Adjusting the position of the image on the projected screen .....	33
Displaying a Test Pattern .....	34
Adjusting the Position of the Projected Image (Lens shift) .....	35
Adjusting the tilt of the projected image (for normal installment) .....	36
Adjusting the Zoom .....	37
Adjusting the Focus .....	37
When using a short throw zoom lens ELPLU02 .....	38

ID Settings .....	39
Setting the projector ID .....	39
Checking the projector ID .....	39
Setting the remote control ID .....	40

### Connecting Equipment ..... 41

Connecting a Computer .....	41
Connecting Image Sources .....	42
Connecting to an External Monitor .....	44
Connecting a LAN Cable .....	45
Connecting an HDBaseT Transmitter .....	46
Installing the Wireless LAN Unit (ELPAP07) .....	47
Using the Quick Wireless Connection USB Key .....	48

### Batch Setup ..... 49

Setup Using a USB flash drive .....	49
Saving settings to the USB flash drive .....	49
Reflecting saved settings to other projectors .....	51
Setup by Connecting the Computer and Projector with a USB Cable .....	53
Saving settings to a computer .....	53
Reflecting saved settings to other projectors .....	54
When Setup Fails .....	56

## Basic Usage

---

### Projecting Images ..... 58

Automatically Detect Input Signals and Change the Projected Image (Search) . . . .	58
Switching to the Target Image .....	59

### Adjusting Projected Images ..... 60

Correcting Distortion in the Projected Image .....	60
H/V-Keystone .....	61
Quick Corner .....	62
Curved Surface .....	63
Point Correction .....	65
Corner Wall .....	67
Selecting the Projection Quality (Selecting Color Mode) .....	70

Setting Auto Iris . . . . .	71
Changing the Aspect Ratio of the Projected Image . . . . .	72
Changing methods . . . . .	72
Adjusting the Image . . . . .	76
Adjusting the Hue, Saturation, and Brightness . . . . .	76
Gamma adjustment . . . . .	76
Frame Interpolation (EB-Z10005U/EB-Z10000U/EB-Z9875U/EB-Z9870U/EB-Z9750U only) . . . . .	78
Projecting 3D Images . . . . .	78

## Useful Functions

<b>Multi-Projection Function . . . . .</b>	<b>80</b>
Preparation . . . . .	80
Edge Blending . . . . .	81
Adjust the overlapping area of the images (Edge Blending) . . . . .	81
Correcting the brightness . . . . .	83
Fine-tuning the color balance . . . . .	85
Combining Scaled Images . . . . .	89
<b>Projection Functions . . . . .</b>	<b>91</b>
Projecting Two Images Simultaneously (Split Screen) . . . . .	91
Operating procedures . . . . .	91
Restrictions during split screen projection . . . . .	93
Hiding the Image Temporarily (Shutter) . . . . .	94
Freezing the Image (Freeze) . . . . .	95
Enlarging Part of the Image (E-Zoom) . . . . .	95
Saving a User's Logo . . . . .	96
<b>Memory Function . . . . .</b>	<b>98</b>
Saving/Loading/Erasing the Memory . . . . .	98
<b>Scheduling Function . . . . .</b>	<b>100</b>
Setting the Time . . . . .	100
Saving a Schedule . . . . .	101
Setting a schedule . . . . .	101
Lamp Relay Mode . . . . .	102

Checking a schedule . . . . .	104
Editing a schedule . . . . .	105
<b>Security Functions . . . . .</b>	<b>107</b>
Managing Users (Password Protection) . . . . .	107
Kinds of Password Protection . . . . .	107
Setting Password Protection . . . . .	108
Entering the Password . . . . .	109
Restricting Operation . . . . .	110
Control Panel Lock . . . . .	110
Lens Operation Lock . . . . .	111
Remote Control Button Lock . . . . .	111
Anti-Theft Lock . . . . .	112
Installing the wire lock . . . . .	112

## Configuration Menu

<b>Using the Configuration Menu . . . . .</b>	<b>114</b>
<b>List of Functions . . . . .</b>	<b>115</b>
Configuration Menu Table . . . . .	115
Network Menu . . . . .	116
Image Menu . . . . .	117
Signal Menu . . . . .	119
Settings Menu . . . . .	121
Extended Menu . . . . .	122
Network Menu . . . . .	127
Notes on operating the Network menu . . . . .	128
Soft keyboard operations . . . . .	128
Basic menu . . . . .	129
Wireless LAN Menu . . . . .	130
Search access point screen . . . . .	131
Security menu . . . . .	132
Wired LAN menu . . . . .	133
Mail menu . . . . .	134
Others menu . . . . .	135
Reset Menu . . . . .	136



Info Menu (Display Only) . . . . . 136  
 Reset Menu . . . . . 138

## Troubleshooting

**Using the Help . . . . . 140**

**Reading the Indicators . . . . . 141**

**Reading Status Monitor . . . . . 150**

    Checking the Status . . . . . 150

        Understanding the screen . . . . . 151

        Setting the screen display (LCD) . . . . . 152

    Explanations of the Display Content . . . . . 153

**Problem Solving . . . . . 160**

    Problems Relating to Images . . . . . 160

        No images appear . . . . . 160

        Moving images are not displayed . . . . . 160

        Projection stops automatically . . . . . 161

        Not supported. is displayed . . . . . 161

        No Signal. is displayed . . . . . 161

        Images are fuzzy, out of focus, or distorted . . . . . 162

        Interference or distortion appear in images . . . . . 162

        The image is truncated (large) or small, the aspect is not suitable, or the image has been reversed . . . . . 163

        Image colors are not correct . . . . . 164

        Images appear dark . . . . . 165

    Problems when Projection Starts . . . . . 166

        The projector does not turn on . . . . . 166

    Other Problems . . . . . 167

        The remote control does not turn on . . . . . 167

        Nothing appears on the external monitor . . . . . 168

        I want to change the language for messages and menus . . . . . 168

        Email is not received even if a problem occurs in the projector . . . . . 168

        The battery that saves your clock settings is running low. is displayed . . . . . 169

        Cannot change settings using a Web browser . . . . . 169

**Event ID . . . . . 170**

## Maintenance

**Cleaning . . . . . 172**

    Cleaning the Projector's Surface . . . . . 172

    Cleaning the Lens . . . . . 172

    Cleaning the Air Filter . . . . . 172

**Replacing Consumables . . . . . 175**

    Replacing the Lamp . . . . . 175

        Lamp replacement period . . . . . 175

        How to replace the lamp . . . . . 176

        Resetting the lamp hours . . . . . 179

    Replacing the Air Filter . . . . . 179

        Air filter replacement period . . . . . 179

        How to replace the air filter . . . . . 179

**Image Maintenance . . . . . 181**

    Panel Alignment . . . . . 181

    Color Uniformity . . . . . 183

## Appendix

**Monitoring and Controlling . . . . . 186**

    About EasyMP Monitor . . . . . 186

        About Message Broadcasting . . . . . 186

    Changing Settings Using a Web Browser (Web Control) . . . . . 186

        Setting the projector . . . . . 186

        Displaying the Web Control Screen . . . . . 187

    Using the Using Mail Notification to Report Problems . . . . . 187

        Reading error notification emails . . . . . 188

    Management Using SNMP . . . . . 189

    Displaying the Web Remote Screen . . . . . 189

        Operating the lens . . . . . 190

    ESC/VP21 Commands . . . . . 191

Command list .....	191
Cable layouts .....	191
About PJLink .....	192
About Crestron RoomView® .....	193
Operating the projector from the computer .....	194
<b>Optional Accessories and Consumables .....</b>	<b>198</b>
Optional Accessories .....	198
Consumables .....	199
<b>Screen Size and Projection Distance .....</b>	<b>200</b>
for EB-Z10005U/EB-Z10000U/EB-Z9875U/EB-Z9870U/EB-Z9750U/EB-Z11000W/EB-Z9900W/EB-Z9800W .....	200
Standard zoom lens ELPLS04 .....	200
Short throw zoom lens ELPLU02 .....	201
Rear projection wide lens ELPLR04 .....	202
Wide zoom lens ELPLW04 .....	203
Middle throw zoom lens ELPLM06 .....	205
Middle throw zoom lens ELPLM07 .....	206
Long throw zoom lens ELPLL07 .....	207
Projection Distances for EB-Z11005/EB-Z11000/EB-Z9870 .....	208
Standard zoom lens ELPLS04 .....	209
Short throw zoom lens ELPLU02 .....	210
Rear projection wide lens ELPLR04 .....	211
Wide zoom lens ELPLW04 .....	212
Middle throw zoom lens ELPLM06 .....	213
Middle throw zoom lens ELPLM07 .....	214
Long throw zoom lens ELPLL07 .....	216
<b>Supported Monitor Displays .....</b>	<b>218</b>
Supported Resolutions .....	218
Computer signals (analog RGB) .....	218
Component video .....	218
Composite video .....	218
Input Signals from the DVI-D input port, HDMI input port, and HDBaseT port*1. ....	219
Input Signals from SDI Input Port(For EB-Z10005U/EB-Z10000U/EB-Z9875U/EB-Z9870U only) .....	219

<b>Specifications .....</b>	<b>220</b>
Projector General Specifications .....	220
<b>Appearance .....</b>	<b>225</b>
<b>Glossary .....</b>	<b>226</b>
<b>General Notes .....</b>	<b>228</b>
About Notations .....	228
Trademarks and Copyrights .....	229
<b>Index .....</b>	<b>230</b>





# Introduction

This chapter explains the names for each part.

The illustrations in this guide are for projectors with the standard zoom lens ELPLS04.

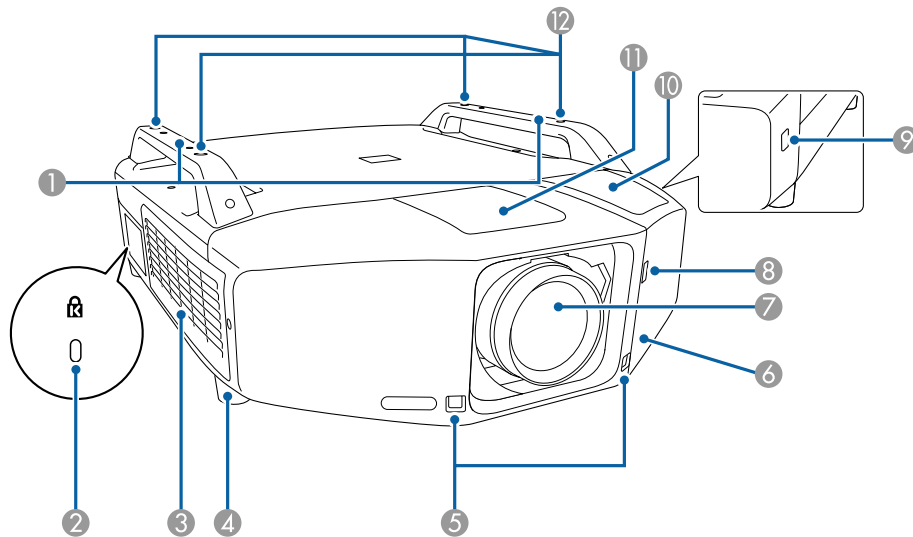
## Front/Top



Name	Function
① <b>Handles</b>	Use these handles when carrying the projector. Also, you can pass an anti-theft wire lock through the handle to secure the projector. ☛ "Installing the wire lock" <a href="#">p.112</a>
② <b>Security slot (  )</b>	The security slot is compatible with the Microsaver Security System manufactured by Kensington. ☛ "Installing the wire lock" <a href="#">p.112</a>

Name	Function
③ <b>Air intake vent (Air filter)</b>	Takes in air to cool the projector internally. If dust collects here it can cause the internal temperature to rise, and this can lead to problems with operation and shorten the optical engine's service life. Be sure to clean the air filter regularly. ☛ "Cleaning the Air Filter" <a href="#">p.172</a> ☛ "Replacing the Air Filter" <a href="#">p.179</a>
④ <b>Front feet</b>	When setting up on a desk, turn to extend and retract to adjust the horizontal tilt. The front feet can be removed when the projector is installed on a ceiling. ☛ "Adjusting the tilt of the projected image (for normal installment)" <a href="#">p.36</a>
⑤ <b>Remote receiver</b>	Receives signals from the remote control. ☛ "Remote control operating range" <a href="#">p.24</a>
⑥ <b>Interface cover</b>	Remove this cover to connect cables to the ports inside when connecting the projector to video equipment. ☛ "Interface" <a href="#">p.16</a> ☛ "Attaching and Removing the Interface Cover" <a href="#">p.28</a>
⑦ <b>Projection lens</b>	Images are projected through here.
⑧ <b>Interface cover removal switch</b>	Operate this when removing the interface cover. ☛ "Attaching and Removing the Interface Cover" <a href="#">p.28</a>
⑨ <b>Interface cover removal button</b>	Operate this when removing the interface cover. ☛ "Attaching and Removing the Interface Cover" <a href="#">p.28</a>
⑩ <b>Cable wiring slot (top)</b>	Remove the cover, and pass the cable up through here. ☛ "Attaching and Removing the Interface Cover" <a href="#">p.28</a>
⑪ <b>Lens replacement cover</b>	Remove when attaching or removing the lens. ☛ "Attaching the Projector Lens Unit" <a href="#">p.26</a>

Name	Function
<b>12 Ceiling mount fixing points (4 points)</b>	Attach the optional ceiling mount here when suspending the projector from a ceiling. 🖱️ "Optional Accessories" <a href="#">p.198</a>

## Rear

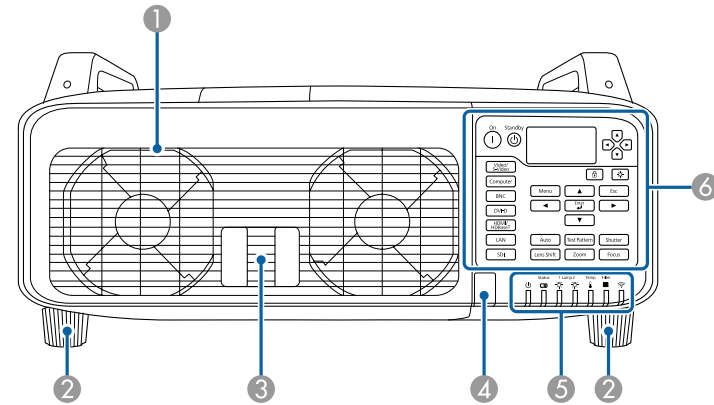

Name	Function
<b>1 Air exhaust vent (Lamp cover)</b>	Exhaust vent for air used to cool the projector internally. Open this cover to replace the projector's lamps.
<b>2 Rear feet</b>	When setting up on a desk, turn to extend and retract to adjust the horizontal tilt. The front feet can be removed when the projector is installed on a ceiling. 🖱️ "Adjusting the tilt of the projected image (for normal installment)" <a href="#">p.36</a>
<b>3 Lamp cover open lever</b>	Use this lever to open the lamp cover. 🖱️ "Replacing the Lamp" <a href="#">p.175</a>
<b>4 Remote receiver</b>	Receives signals from the remote control. 🖱️ "Remote control operating range" <a href="#">p.24</a>
<b>5 Status indicators</b>	The color of the indicators and whether they are flashing or lit indicate the status of the projector. 🖱️ "Reading the Indicators" <a href="#">p.141</a>
<b>6 Control panel</b>	🖱️ "Control panel" <a href="#">p.18</a>

## Base

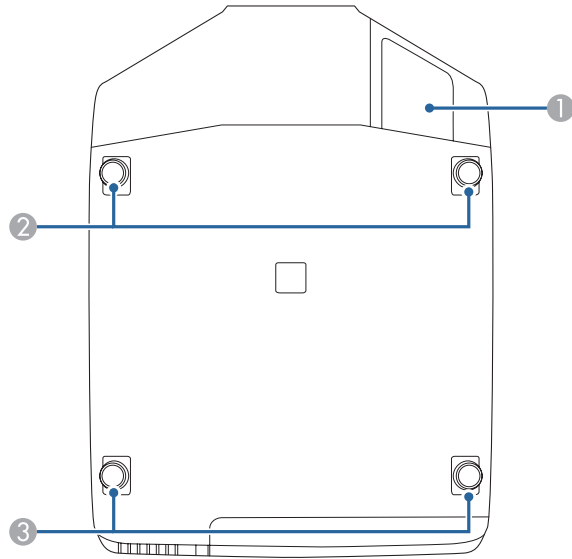

Name	Function
① Cable wiring slot (bottom)	Remove the cover, and pass the cable down through here. ☛ "Attaching and Removing the Interface Cover" p.28
② Front feet	☛ "Adjusting the tilt of the projected image (for normal installment)" p.36
③ Rear feet	☛ "Adjusting the tilt of the projected image (for normal installment)" p.36

## Interface

You can access the following ports by removing the interface cover. For information on how to remove the interface cover and connect video equipment, see the following.

- ☛ "Attaching and Removing the Interface Cover" p.28
- ☛ "Connecting Equipment" p.41

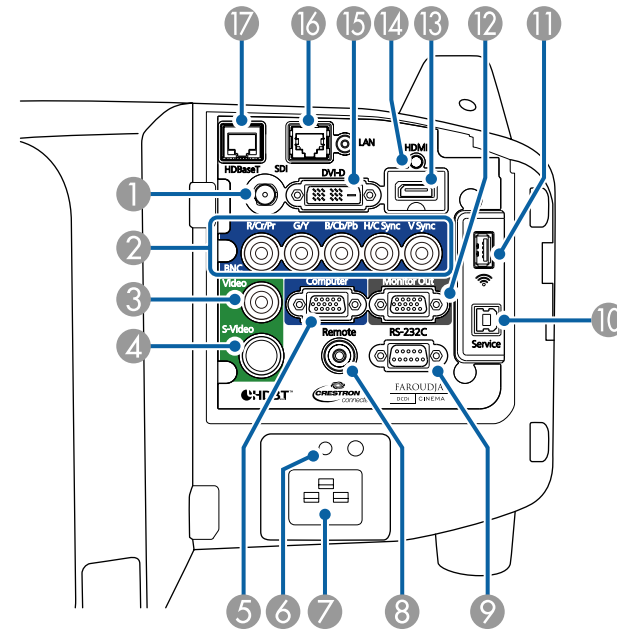

Name	Function
① SDI input port (For EB-Z10005U/EB-Z10000U/EB-Z9875U/EB-Z9870U only)	Inputs SDI signals from video equipment.
② BNC input port	For analog RGB signals from a computer and component video signals from other video sources.
③ Video input port	For composite video signals from video sources.

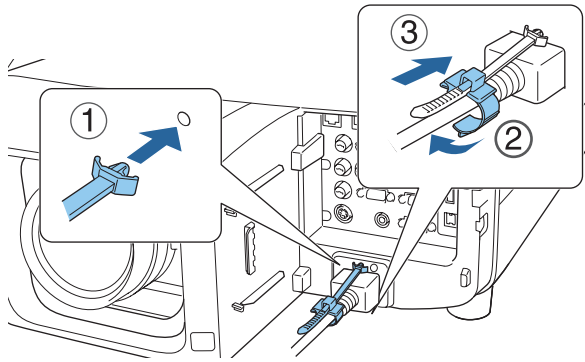

Name	Function
④ <b>S-Video input port</b>	For S-video signals from video sources.
⑤ <b>Computer input port</b>	For analog RGB signals from a computer and component video signals from other video sources.
⑥ <b>Cable holder</b>	Insert the supplied cord clamp here to prevent the cord from falling out. 
⑦ <b>Power inlet</b>	Connects the power cord to the projector. The shape may differ depending on your projector model.
⑧ <b>Remote port</b>	Connects the optional remote control cable set and inputs signals from the remote control. When the remote control cable is plugged into this port, the remote receiver on the projector is disabled. ☛ "Optional Accessories" p.198
⑨ <b>RS-232C port</b>	When controlling the projector from a computer, connect it to the computer with an RS-232C cable. ☛ "Serial connection" p.191
⑩ <b>Service port</b>	This port is used by maintenance personnel to control the projector. This is used for batch settings. ☛ "Batch Setup" p.49

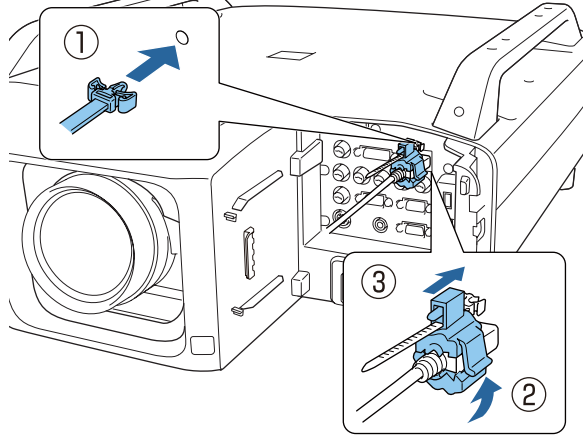





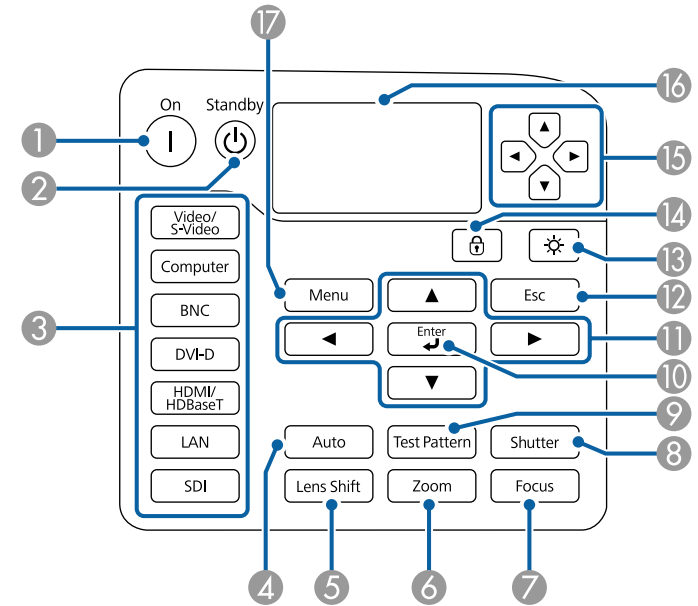



Name	Function
⑪ <b>Wireless LAN unit port</b>	<ul style="list-style-type: none"> <li>Connects the optional wireless LAN unit. ☛ "Installing the Wireless LAN Unit (ELPAP07)" p.47</li> <li>Connects the optional Quick Wireless Connection USB Key. ☛ "Using the Quick Wireless Connection USB Key" p.48</li> <li>This is used for batch settings. ☛ "Batch Setup" p.49</li> </ul>
⑫ <b>Monitor out port</b>	Outputs analog RGB signals input from the Computer input port or the BNC input port to an external monitor. This is not available for component video signals or other signals being input from any port other than the Computer input port or the BNC input port. ☛ "Cable layouts" p.191
⑬ <b>HDMI input port</b>	Inputs image signals from HDMI compatible video equipment and computers. This projector is compatible with <b>HDCP</b> ▶▶.
⑭ <b>Cable holder</b>	Insert the supplied HDMI cable clamp here to prevent the HDMI cable from falling out. 
⑮ <b>DVI-D input port</b>	Inputs the computer DVI-D signals.



Name	Function
16 LAN port	Connects a LAN cable to connect to a network. ☞ "Connecting a LAN Cable" p.45
17 HDBaseT port	Connects a LAN cable to the optional HDBaseT Transmitter. ☞ "Connecting an HDBaseT Transmitter" p.46

## Control panel



Name	Function
1 [⏻] button	Press to turn on the projector.
2 [⏻] button	Press to turn off the projector.
3 Change input buttons	Press to change to signals from each input port. ☞ "Switching to the Target Image" p.59 The [SDI] button is only available for EB-Z10005U/EB-Z10000U/EB-Z9875U/EB-Z9870U.
4 [Auto] button	If pressed while projecting analog RGB signals from the Computer input port or the BNC input port, you can automatically optimize Tracking, Sync., and Position.

Name	Function
5 [Lens Shift] button	<p>Press to adjust the lens shift.</p> <p> "Adjusting the Position of the Projected Image (Lens shift)" <a href="#">p.35</a></p> <p>If pressed for more than five seconds, the lens position returns to the center.</p>
6 [Zoom] button	<p>Press to adjust the zoom.</p> <p> "Adjusting the Zoom" <a href="#">p.37</a></p>
7 [Focus] button	<p>Press to adjust the focus.</p> <p> "Adjusting the Focus" <a href="#">p.37</a></p>
8 [Shutter] button	<p>Press to turn the signals on or off temporarily.</p> <p> "Hiding the Image Temporarily (Shutter)" <a href="#">p.94</a></p>
9 [Test Pattern] button	<p>Displays a test pattern.</p> <p> "Displaying a Test Pattern" <a href="#">p.34</a></p>
10 [↵] button	<p>If pressed while the Configuration menu or the Help screen is displayed, it determines an item or moves to the next level.</p> <p> "Using the Configuration Menu" <a href="#">p.114</a></p>
11 [▲][▼][◀][▶] buttons	<ul style="list-style-type: none"> <li>Press to adjust focus, zoom, and lens shift.           <ul style="list-style-type: none"> <li> "Adjusting the Position of the Projected Image (Lens shift)" <a href="#">p.35</a></li> <li> "Adjusting the Zoom" <a href="#">p.37</a></li> <li> "Adjusting the Focus" <a href="#">p.37</a></li> </ul> </li> <li>If pressed when the Configuration menu or the Help screen is displayed, menu items and setting values are selected.           <ul style="list-style-type: none"> <li> "Using the Configuration Menu" <a href="#">p.114</a></li> </ul> </li> </ul>
12 [Esc] button	<ul style="list-style-type: none"> <li>Press to stop the current function.</li> <li>If pressed when the Configuration menu is displayed, it returns to the previous menu level.           <ul style="list-style-type: none"> <li> "Using the Configuration Menu" <a href="#">p.114</a></li> </ul> </li> </ul>
13 [☀] button	<p>Press to turn on or off the buttons on the control panel and the status monitor.</p>

Name	Function
14 [🔒] button	<p>Press to display the Control Panel Lock screen allowing you to make settings to lock the control panel buttons.</p> <p> "Restricting Operation" <a href="#">p.110</a></p>
15 [🏠][⬆️][⬇️][⬅️][➡️] buttons	<p>Press to select the menu items and setting values for status monitor to monitor the projector's status.</p>
16 Status monitor	<p>Displays the projector's status by character information.</p> <p> "Reading Status Monitor" <a href="#">p.150</a></p>
17 [Menu] button	<p>Press to display and close the Configuration menu.</p> <p> "Using the Configuration Menu" <a href="#">p.114</a></p>

## Remote Control

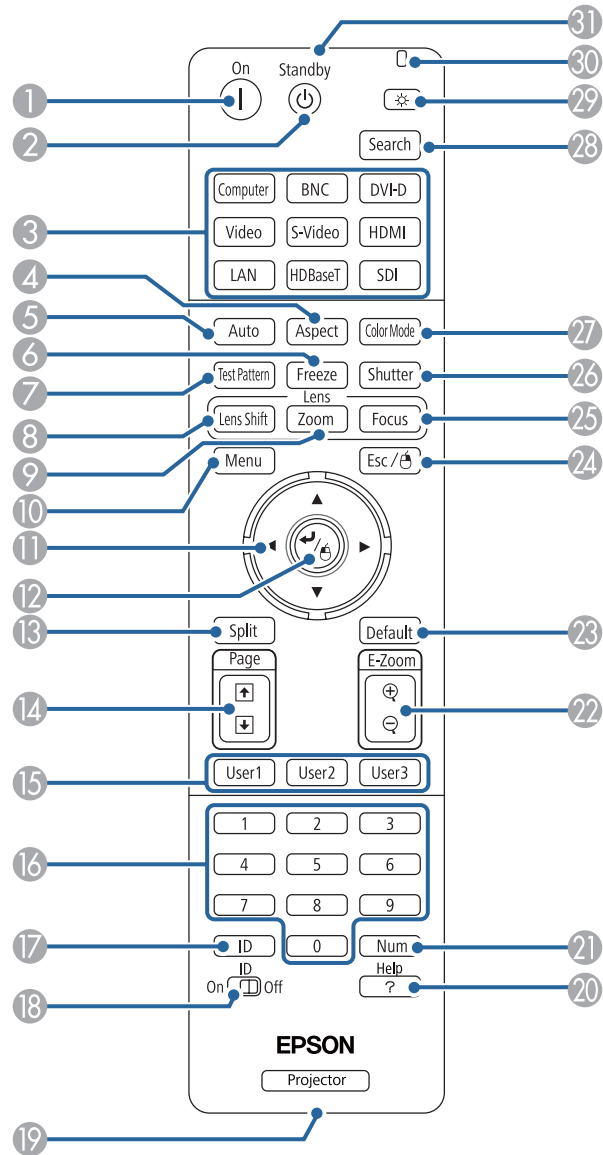

Name	Function
1 [I] button	Press to turn the projector on.
2 [O] button	Press to turn the projector off.
3 Change input buttons	Press to change to signals from each input port. ☛ "Switching to the Target Image" p.59 The [SDI] button is only available for EB-Z10005U/EB-Z10000U/EB-Z9875U/EB-Z9870U.
4 [Aspect] button	Each time the button is pressed, the aspect mode changes. ☛ "Changing the Aspect Ratio of the Projected Image" p.72
5 [Auto] button	If pressed while projecting analog RGB signals from the Computer input port or the BNC input port, you can automatically optimize Tracking, Sync., and Position.
6 [Freeze] button	Press to pause or unpause the images. ☛ "Freezing the Image (Freeze)" p.95
7 [Test Pattern] button	Displays a test pattern. ☛ "Displaying a Test Pattern" p.34
8 [Lens Shift] button	Press to adjust the lens shift. ☛ "Adjusting the Position of the Projected Image (Lens shift)" p.35 If pressed for more than five seconds, the lens position returns to the center.
9 [Zoom] button	Press to adjust the zoom. ☛ "Adjusting the Zoom" p.37
10 [Menu] button	Press to display and close the Configuration menu. ☛ "Using the Configuration Menu" p.114



Name	Function
11 [▲][▼][◀][▶] buttons	<ul style="list-style-type: none"> <li>Press to adjust focus, zoom, and lens shift.                             <ul style="list-style-type: none"> <li>"Adjusting the Position of the Projected Image (Lens shift)" p.35</li> <li>"Adjusting the Zoom" p.37</li> <li>"Adjusting the Focus" p.37</li> </ul> </li> <li>When the Configuration menu or the Help screen is displayed, pressing these buttons selects menu items and setting values.                             <ul style="list-style-type: none"> <li>"Using the Configuration Menu" p.114</li> </ul> </li> <li>When using the optional wireless mouse receiver, pressing these buttons moves the pointer.                             <ul style="list-style-type: none"> <li>"Optional Accessories" p.198</li> </ul> </li> </ul>
12 [↵] button	<ul style="list-style-type: none"> <li>If pressed while the Configuration menu or the Help screen is displayed, it determines an item or moves to the next level.                             <ul style="list-style-type: none"> <li>"Using the Configuration Menu" p.114</li> </ul> </li> <li>Acts as a mouse's left button when using the optional wireless mouse receiver.                             <ul style="list-style-type: none"> <li>"Optional Accessories" p.198</li> </ul> </li> </ul>
13 [Split] button	<p>Each time you press the button, the image changes between projecting two images simultaneously by splitting the projected screen, or projecting one image as normal.</p> <ul style="list-style-type: none"> <li>"Projecting Two Images Simultaneously (Split Screen)" p.91</li> </ul>
14 [Page] buttons [⏪][⏩]	<ul style="list-style-type: none"> <li>Moves to the previous or next image file when projecting images from a computer connected via a network.</li> <li>When using the optional wireless mouse receiver, you can change the PowerPoint file page during projection by pressing the page up/page down buttons.</li> </ul>
15 [User 1] button [User 2] button [User 3] button	<p>Select any frequently used item from the nine available Configuration menu items, and assign it to one of these buttons.</p> <ul style="list-style-type: none"> <li>"Settings Menu" p.121</li> </ul>

Name	Function
16 Numeric buttons	<ul style="list-style-type: none"> <li>Enter the password.                             <ul style="list-style-type: none"> <li>"Setting Password Protection" p.108</li> </ul> </li> <li>Use this button to enter numbers in <b>Network</b> settings in the Configuration menu.</li> </ul>
17 [ID] button	<p>Hold down this button and press the numeric buttons to select the ID for the projector you want to operate using the remote control.</p> <ul style="list-style-type: none"> <li>"ID Settings" p.39</li> </ul>
18 [ID] switch	<p>Press this switch to enable (On)/disable (Off) ID settings for the remote control.</p> <ul style="list-style-type: none"> <li>"ID Settings" p.39</li> </ul>
19 Remote port	<p>Connects the optional remote control cable set and outputs signals from the remote control.</p> <ul style="list-style-type: none"> <li>"Optional Accessories" p.198</li> </ul> <p>When the remote control cable is plugged into this remote port, the remote control light-emitting area is disabled.</p>
20 [Help] button	<p>Press to display and closes the Help screen which shows you how to deal with problems if they occur.</p> <ul style="list-style-type: none"> <li>"Using the Help" p.140</li> </ul>
21 [Num] button	<p>Hold down this button and press the numeric buttons to enter passwords and numbers.</p> <ul style="list-style-type: none"> <li>"Setting Password Protection" p.108</li> </ul>
22 [E-Zoom] buttons [⊕][⊖]	<p>Press to enlarge or reduce the image without changing the projection size.</p> <ul style="list-style-type: none"> <li>"Enlarging Part of the Image (E-Zoom)" p.95</li> </ul>
23 [Default] button	<p>Enabled when "[Default]: Reset" is displayed on the Configuration menu guide. The settings being adjusted are returned to their default values.</p> <ul style="list-style-type: none"> <li>"Using the Configuration Menu" p.114</li> </ul>

Name	Function
24 [Esc] button	<ul style="list-style-type: none"> <li>Press to stop the current function.</li> <li>If pressed when the Configuration menu is displayed, it moves to the previous level.                             <ul style="list-style-type: none"> <li>"Using the Configuration Menu" p.114</li> </ul> </li> <li>Acts as a mouse's right button when using the optional wireless mouse receiver.                             <ul style="list-style-type: none"> <li>"Optional Accessories" p.198</li> </ul> </li> </ul>
25 [Focus] button	<p>Press to adjust the focus.</p> <ul style="list-style-type: none"> <li>"Adjusting the Focus" p.37</li> </ul>
26 [Shutter] button	<p>Press to turn the image on or off temporarily.</p> <ul style="list-style-type: none"> <li>"Hiding the Image Temporarily (Shutter)" p.94</li> </ul>
27 [Color Mode] button	<p>Each time the button is pressed, the color mode changes.</p> <ul style="list-style-type: none"> <li>"Selecting the Projection Quality (Selecting Color Mode)" p.70</li> </ul>
28 [Search] button	<p>Press to change to the next input source that is sending an image.</p> <ul style="list-style-type: none"> <li>"Automatically Detect Input Signals and Change the Projected Image (Search)" p.58</li> </ul>
29 [☀️] button	<p>Press to illuminate the buttons on the remote control for approximately 15 seconds. This is useful when using the remote control in the dark.</p>
30 Indicator	<p>A light is emitted when outputting remote control signals.</p>
31 Remote control light-emitting area	<p>Outputs remote control signals.</p>

You can perform the following operations by simply pressing one of the buttons on the remote control.

Operation	Set
<p>Selecting the password security settings.</p> <ul style="list-style-type: none"> <li>"Managing Users (Password Protection)" p.107</li> </ul>	<p>Hold down the [Freeze] button for more than five seconds. The <b>Password Protection</b> screen is displayed, and you can select various settings.</p>
<p>Locking or unlocking some of the operation of the buttons on the remote control.</p> <ul style="list-style-type: none"> <li>"Restricting Operation" p.110</li> </ul>	<p>Hold down the [Help] button for more than five seconds.</p>
<p>Initializing the settings for the <b>remote receiver</b> in the Configuration menu. (Enables all Remote receiver for this projector.)</p>	<p>Hold down the [Menu] button for more than 15 seconds.</p>
<p>Displaying frequently used Configuration menu items.</p>	<p>Press the [User1], [User2], or [User3] button. You can set the menu item you want to assign to each button in <b>User Button</b>.</p> <ul style="list-style-type: none"> <li><b>Settings - User Button</b> p.121</li> </ul> <p>The following items can be assigned.  <b>Power Consumption, Info, Progressive, Geometric Correction, Multi-Projection, Resolution, Memory, Image Processing, or On-Screen Display</b></p> <p>When you press the button for which <b>On-Screen Display</b> is assigned, menu or messages are not displayed on the screen. When the same button is pressed, they are displayed again. If <b>On-Screen Display</b> is enabled, you cannot operate the Configuration menu (except switching the Color Mode and input source).</p>

## Replacing the remote control batteries

If delays in the responsiveness of the remote control occur or if it does not operate after it has been used for some time, it could mean that the batteries are running low. When this happens, replace them with new batteries. Have two AA size alkaline or manganese batteries ready. You cannot use other batteries except for the AA size alkaline or manganese.

### Attention

Make sure you read the following manual before handling the batteries.

 [Safety Instructions](#)

### 1 Remove the battery cover.

Release the battery compartment cover catch, and then lift up the cover.

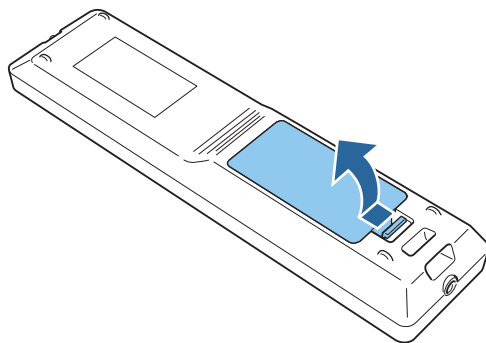

### 2 Replace the old batteries with new batteries.

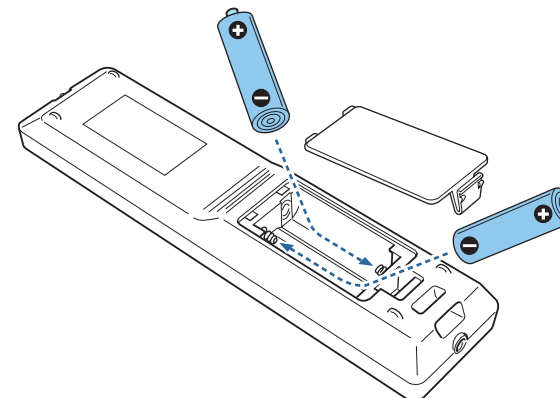

### Caution

Check the positions of the (+) and (-) marks inside the battery holder to ensure the batteries are inserted the correct way.

If the batteries are not used correctly, they could explode or leak causing a fire, injury, or damage to the product.

### 3 Reattach the battery cover.

Press the battery compartment cover until it clicks into place.

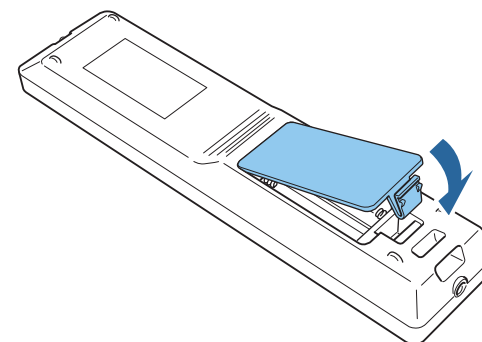

## Remote control operating range

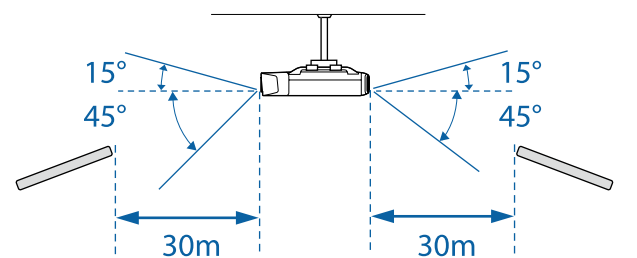
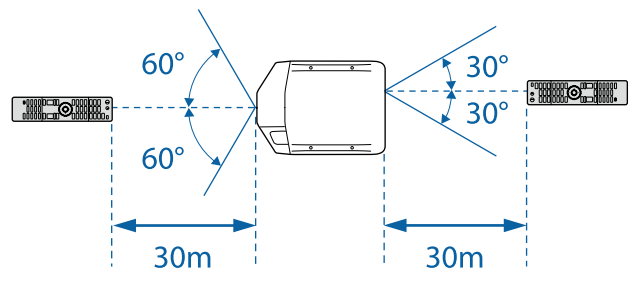





# Preparing the Projector

This chapter explains how to install the projector and connect projection sources.

## Attaching the Projector Lens Unit

### Attaching

#### Attention

- Do not attach the lens unit when the projector's lens insertion section is facing up. Dust or dirt could enter the projector.
- Try not to touch the lens section with your hand or fingers. If fingerprints or oils are left on the surface of the lens, projection quality deteriorates.



To make sure that keystone correction is performed correctly, set the **Lens Type** in the Configuration menu according to the lens you are using.

☛ **Extended - Operation - Advanced - Lens Type** [p.122](#)

- 1** Remove the lens replacement cover.  
Lightly press the lens replacement cover. When the rear part rises, remove the lens replacement cover.

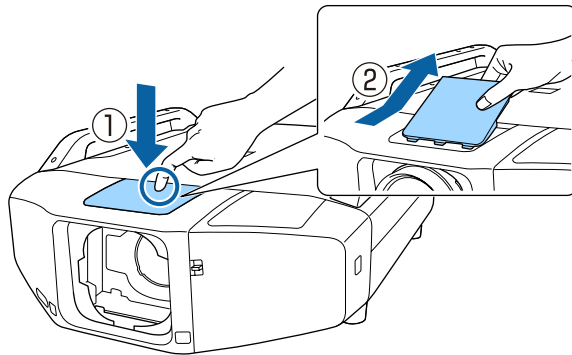

- 2** Turn the lock lever counterclockwise.

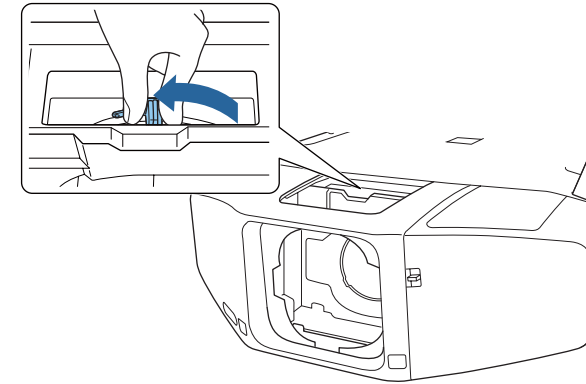

- 3** Insert the lens unit straight into the lens insertion section with the white circle on the lens on top.

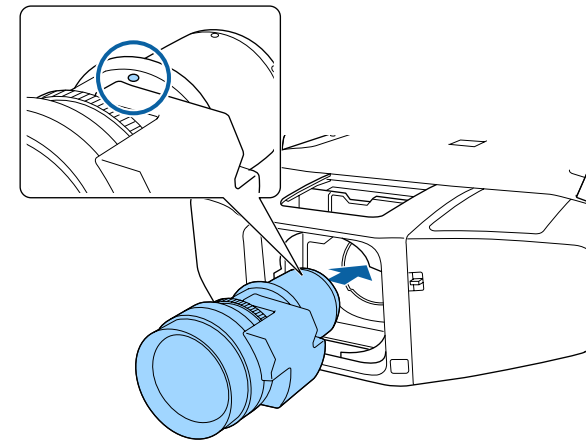

- 4 While holding the lens unit firmly, turn the lock lever clockwise until it is locked.

Check that the lens cannot be detached.

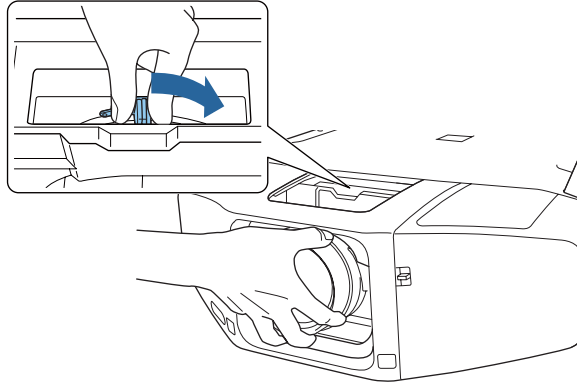

- 5 Attach the lens replacement cover.

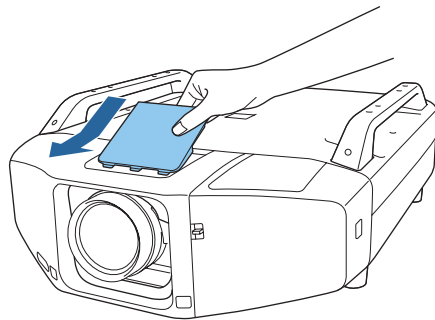

## Removing

### Attention

When replacing the lens unit, turn off the power first. If lens shift has been performed, set the lens shift to the center before replacing the lens unit.

☛ "Adjusting the Position of the Projected Image (Lens shift)" p.35

- 1 Remove the lens replacement cover.  
Lightly press the lens replacement cover. When the rear part rises, remove the lens replacement cover.

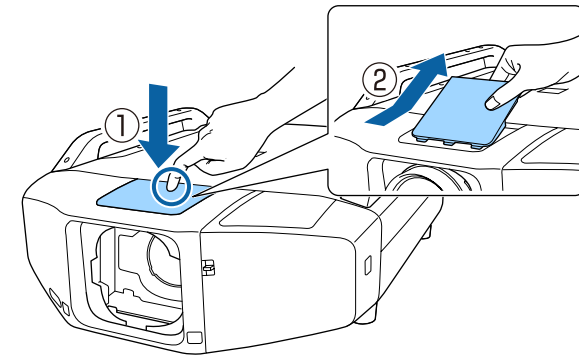

- 2** While holding the lens unit firmly, turn the lock lever counterclockwise until it is unlocked.

Pull the lens unit straight out as it is released.

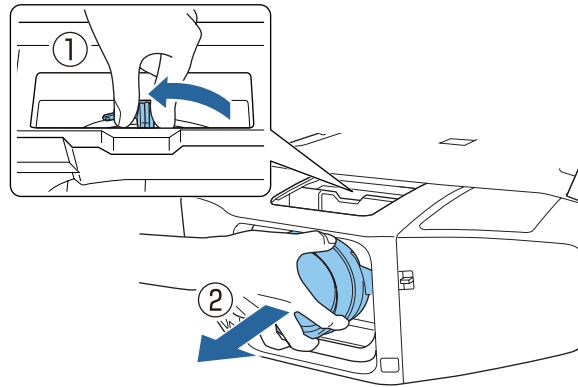

## Attaching and Removing the Interface Cover

Remove the interface cover before installing the projector so that it is easier to connect the cable after installation.

### Removing

While pushing up the switch, press the button on the side and pull the interface cover straight out.

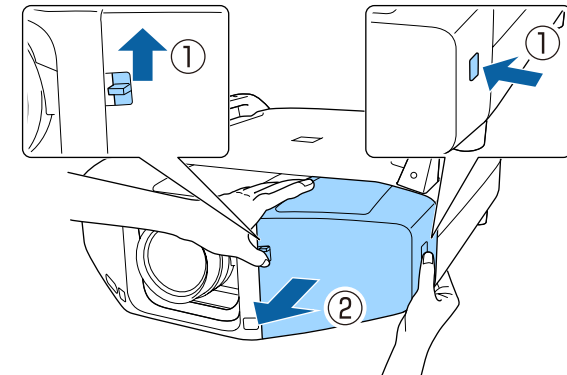

## Attaching

- 1** Remove the top cover when passing the connected cables from the top. Remove the bottom cover when passing the connected cables from the bottom.

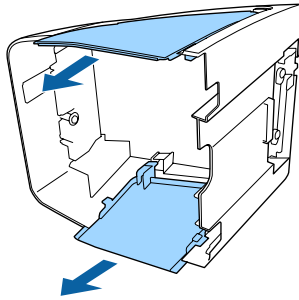

- 2** Press the interface cover along the guide until it clicks into place.

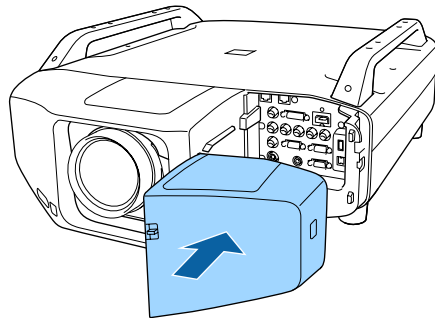

## Installation Settings

### Setting the direction

When installation is complete, set the **Direction** in the Configuration menu according to the vertical installation angle.

#### Attention

Make sure you set the **Direction** correctly. Otherwise the lamp's operating life may be reduced significantly.



When performing portrait projection, you do not need to set the **Direction**.

- 1** Press the [ⓘ] button to turn on the projector.  
If the images are out of focus, press the [Focus] button to adjust.  
☛ "Adjusting the Focus" [p.37](#)
- 2** Press the [Menu] button.
- 3** Select **Direction** from **Extended**.

- 4** Press the [▲][▼] buttons to select the installation angle based on the direction of the projector, and then press the [↵] button.

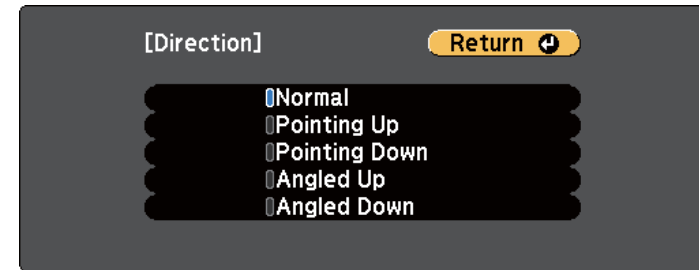

[Esc] / [⏻]:Return [⏮]:Select [Menu]:Exit

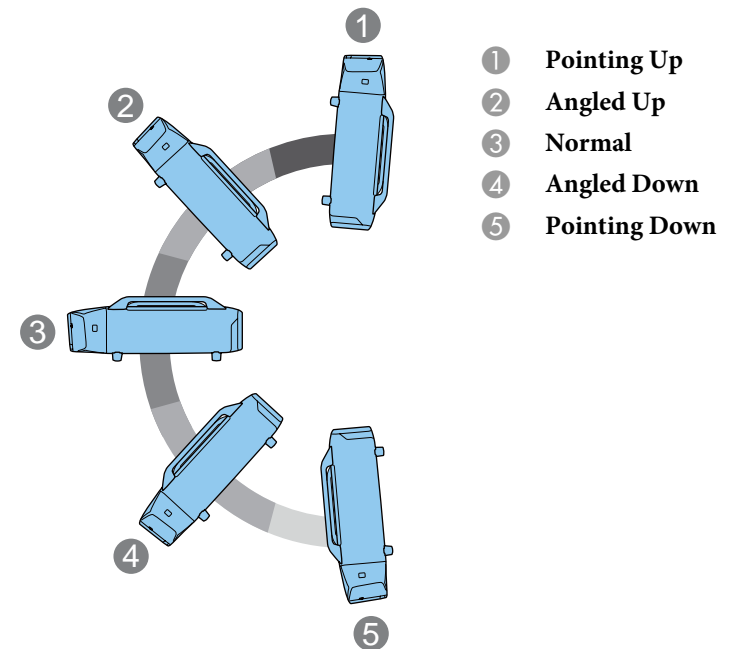

- 5** When the settings are complete, press the [Menu] button.

## Changing the direction of the image (Projection)

You can change the direction of the image using **Projection** mode in the Configuration menu.

☛ **Extended - Projection** p.122

When Front is used, the image directions for each projection mode are as follows.

Front (default)



Rear



Front/Upside Down



Rear/Upside Down



## Selecting the lamp

When the installation is complete, select the lamps you want to turn based on the usage or condition.

- 1** Press the [Menu] button while projecting.
- 2** Select **Lamp Select** from **Extended**.
- 3** Select the lamp to be turned on, and then press the [↵] button. The lamp turns on according to the selection.

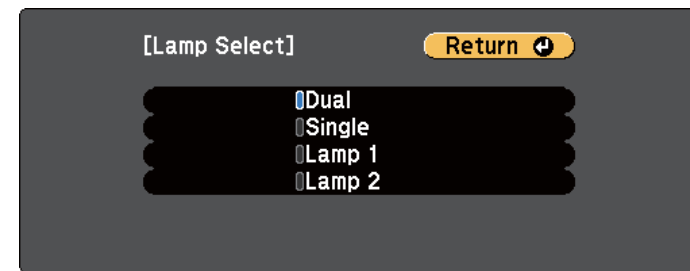

[Esc] / [⏏]:Return [↵]:Select [Menu]:Exit

<b>Dual (default)</b>	Both Lamp 1 and Lamp 2 turn on. When one of the lamps dies, the other lamp remains on.
<b>Single</b>	When the projector is turned on, the lamp with less total operation time turns on. When one of the lamps dies, the other lamp turns on.
<b>Lamp 1</b>	Lamp 1 turns on. When Lamp 1 dies, Lamp 2 turns on.
<b>Lamp 2</b>	Lamp 2 turns on. When Lamp 2 dies, Lamp 1 turns on.

- 4** Press the [Menu] button to finish making settings.



- You can specify the date and time and automatically switch the lamps.  
 ☛ "Scheduling Function" [p.100](#)
- Approximately 120 seconds after changing the **Lamp Select** settings, you cannot change **Lamp Select** or turn off the projector.
- Note that switching the settings for **Lamp Select** in a short time may deteriorate the lamps or cause a malfunction.
- When performing Multi-Projection, set it to **Dual**.
- When a problem or warning occurs in the projector, you may not be able to set **Lamp Select**.
- When the brightness of the lamps is reduced due to Temp Interlock, you cannot set **Lamp Select**.  
 ☛ **Settings - Power Consumption** [p.121](#)

## Screen Settings

Set the Screen Type according to the aspect ratio of the screen being used. The area where the image is displayed matches the shape of the screen.



The settings for the **Screen Type** at the time of purchase are as follows:

- WUXGA/WXGA projector: **16:10**
- XGA projector: **4:3**

- 1** Press the [Menu] button while projecting.  
 ☛ "Using the Configuration Menu" [p.114](#)
- 2** Select **Display** from **Extended**.
- 3** Select **Screen Type** from **Screen**.
- 4** Select the screen's aspect ratio from **4:3**, **16:9**, and **16:10**.  
 The shape of the background test pattern changes depending on the setting.

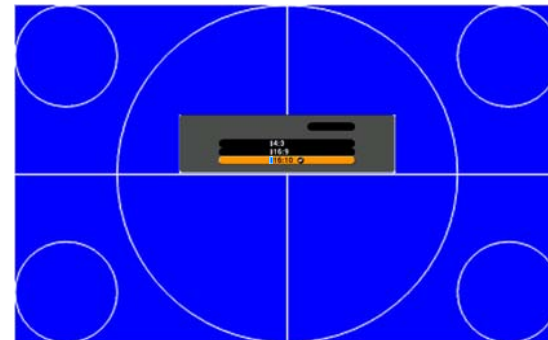



**5** Press the [Menu] button to finish making settings.



- When you change the Screen Type, adjust the aspect ratio for the projected image as well.
  - ☛ "Changing the Aspect Ratio of the Projected Image" p.72
- This function does not support Message Broadcasting (an EasyMP Monitor plugin).

## Adjusting the position of the image on the projected screen

You can adjust the position of the image if there are margins between the edge of the image and the projected screen frame due to the Screen Type setting.



- The Screen Position cannot be adjusted in the following situations.
- If you are using a WUXGA/WXGA projector and the **Screen Type** is set to **16:10**
  - If you are using an XGA projector and the **Screen Type** is set to **4:3**

Example: If you are using a WUXGA/WXGA projector and the **Screen Type** is set to **4:3**

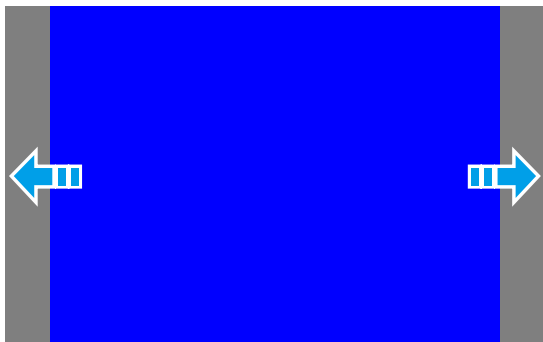

You can move the image to the left and right.

- 1** Press the [Menu] button while projecting.  
☛ "Using the Configuration Menu" p.114
- 2** Select **Display** from **Extended**.
- 3** Select **Screen Position** from **Screen**.
- 4** Use [**▲**][**▼**][**◀**][**▶**] buttons to adjust the position of the image.  
You can check the current display position by using the background test pattern.

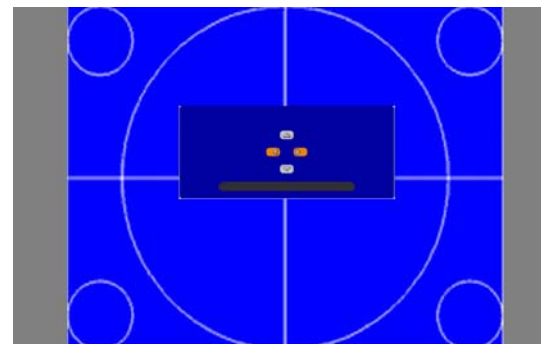

**5** Press the [Menu] button to finish making settings.

## Displaying a Test Pattern

A test pattern can be displayed to adjust the projection status without connecting video equipment.

The shape of a test pattern depends on the setting in **Screen Type**. Set the **Screen Type** first.

☛ "Screen Settings" p.32

- 1** Press the [Test Pattern] button while projecting.
- 2** Press the [◀][▶] buttons on the remote control or the [↵] button on the control panel to change the test pattern.

### Using the remote control

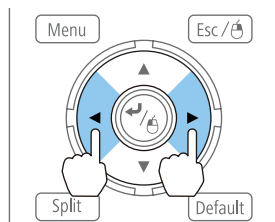

### Using the control panel

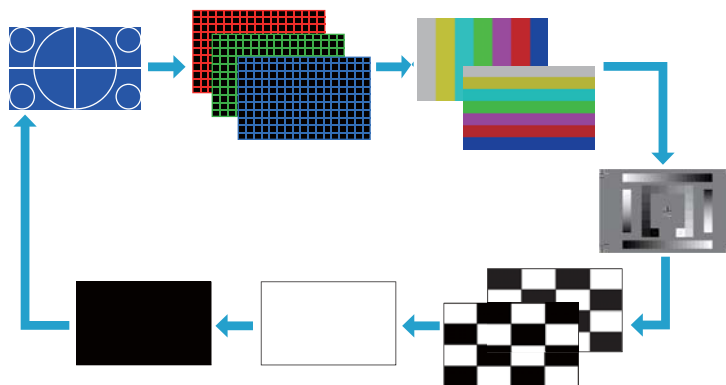
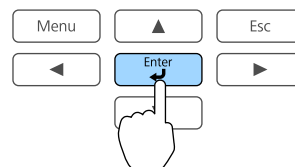

The following image adjustments can be made while the test pattern is being displayed.

Top Menu Name	Sub Menu/Items
<b>Image</b>	Color Mode ☛ p.70
	Color Temp.
	Advanced - Gamma*1 ☛ p.76 - RGB - RGBCMY ☛ p.76
	Reset
<b>Signal</b>	Auto Setup
<b>Settings</b>	Geometric Correction ☛ p.60
<b>Extended</b>	Multi-Projection*2 ☛ p.80

\*1 Except for Customized

\*2 Except for Black Level



To set menu items that cannot be set while the test pattern is being displayed or to fine-tune the projected image, project an image from the connected device.

- 3** Press the [Esc] button to close the test pattern.

## Adjusting the Position of the Projected Image (Lens shift)

The lens can be shifted to adjust the position of the projected image, for example, when the projector cannot be installed directly in front of the screen.

The ranges within which the image can be moved are shown below. The position of the projected image cannot be moved to both the horizontal and vertical maximum values.

EB-Z10005U/EB-Z10000U/EB-Z9875U/EB-Z9870U/EB-Z9750U/EB-Z11000W/EB-Z9900W/EB-Z9800W

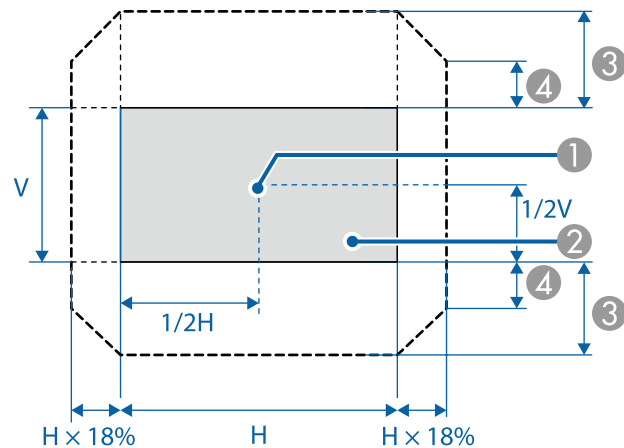

- ① Center of lens
- ② Projected image when lens shift is set in the center
- ③ Maximum motion range:  $V \times 60\%$
- ④ When the horizontal direction is at the maximum value:  $V \times 31\%$

EB-Z11005/EB-Z11000/EB-Z9870

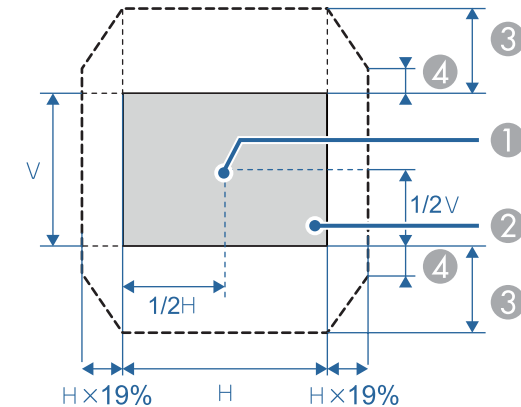

- ① Center of lens
- ② Projected image when lens shift is set in the center
- ③ Maximum motion range:  $V \times 56\%$  (When using a short throw zoom lens ELPLU02, if you move it more than 50%, part of the screen cannot be displayed correctly.)
- ④ When the horizontal direction is at the maximum value:  $V \times 32\%$



- When adjusting the vertical lens shift, adjust by moving the image from the bottom to the top. If it is adjusted from the top to the bottom, the image position may move down slightly after adjusting.
- We recommend setting the focus, zoom, and lens shift at least 20 minutes after you start the projection, because images are not stable right after turning on the projector.
- The image will be clearest when both the vertical and horizontal lens shift are set in the center.
- Hold down the [Lens Shift] button for approximately five seconds, the position of the lens returns to the center.
- The rear short throw zoom lens ELPLR04 does not support lens shift.

**1** Press the [Lens Shift] button.

### Using the remote control

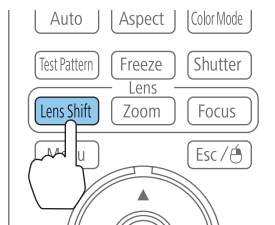

### Using the control panel

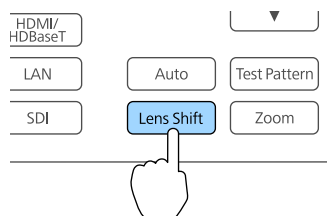

**2** Press the [▲][▼][◀][▶] buttons to adjust the position of the projected image.

### Using the remote control

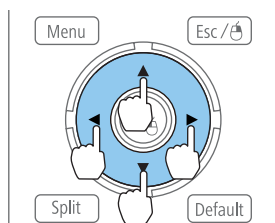

### Using the control panel

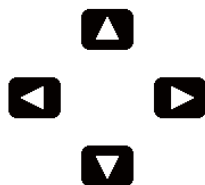
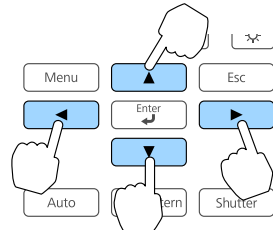

[◀▶]: Adjust Lens Shift      [Esc]: Exit

**3** Press the [Esc] button to finish the adjustment.

## Adjusting the tilt of the projected image (for normal installment)

Extend and retract the front feet and rear feet to adjust the projector's horizontal and vertical tilt. You can adjust within a range of  $\pm 3.5^\circ$ .

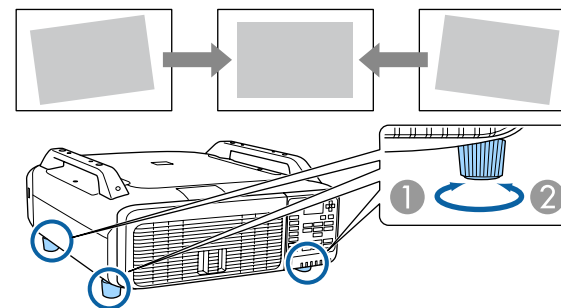

- ① Extend the front feet and rear feet.
- ② Retract the front feet and rear feet.

### Attention

The front feet and rear feet can be attached and removed. Note that the feet will detach if they are extended more than 10 mm.

## Adjusting the Zoom

- 1 Press the [Zoom] button.

Using the remote control

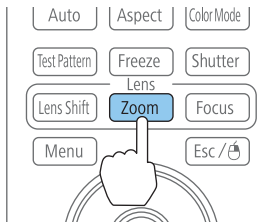

Using the control panel

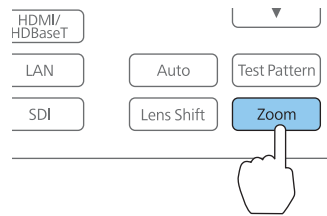

- 2 Press the [◀][▶] buttons to adjust.

Using the remote control

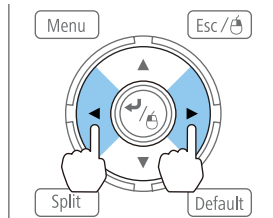

Using the control panel

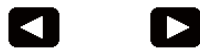
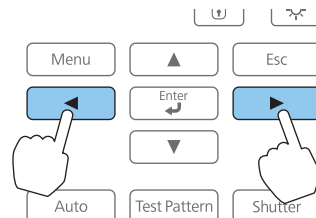

[◀▶]:Adjust Zoom [Esc]:Exit

- 3 Press the [Esc] button to finish the adjustment.

## Adjusting the Focus

- 1 Press the [Focus] button.

Using the remote control

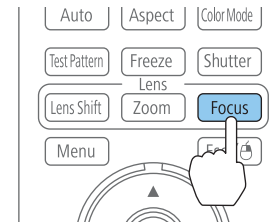

Using the control panel

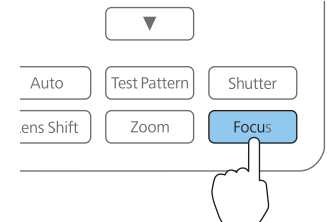

- 2 Press the [◀][▶] buttons to adjust.

Using the remote control

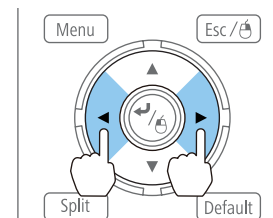

Using the control panel

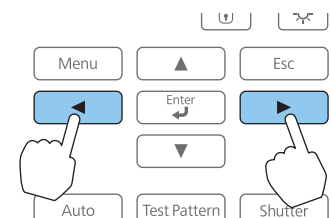

[◀▶]:Adjust Focus [Esc]:Exit

- 3 Press the [Esc] button to finish the adjustment.

## When using a short throw zoom lens ELPLU02

Follow the steps below to adjust the focus when the lens is shifted up, down, left, or right using the lens shift function.

- 1 Turn the distortion ring counterclockwise until it cannot go any further.

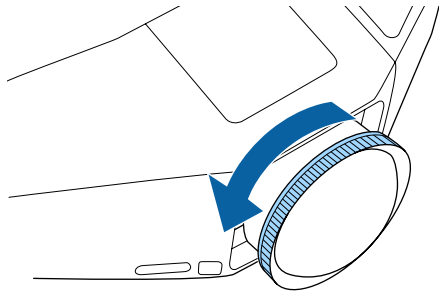

- 2 Focus the image around the center of the lens.

☛ "Adjusting the Focus" [p.37](#)

Example: When the lens shift is turned all the way down.

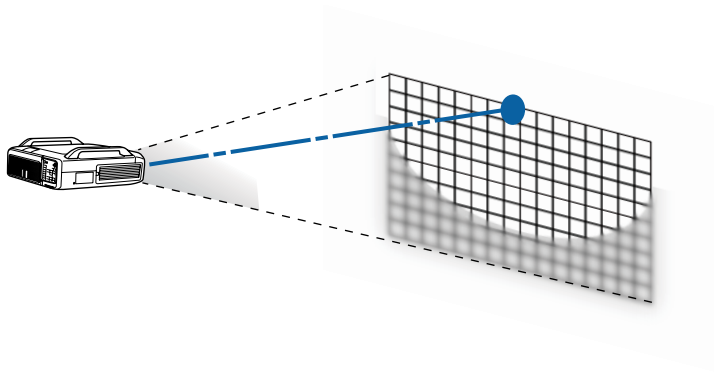

- 3 Correct screen distortion using the distortion ring.

When correcting distortion, the area around the edges of the image is also focused.

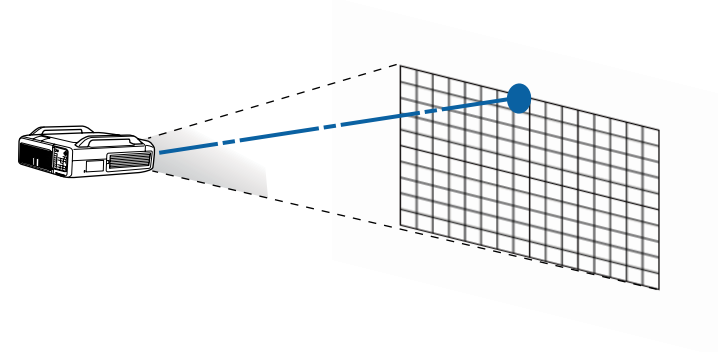

- 4 Focus the entire screen.

If the area around the lens axis is out of focus, fine-tune by turning the distortion ring.

## ID Settings

When an ID is set for the projector and the remote control, you can use the remote control to operate only the projector with a matching ID. This is useful when you use multiple projectors together.



- Operation using the remote control is possible only for projectors that are within the operating range of the remote control.
  - ☛ "Remote control operating range" p.24
- When **Remote Control Type** is set to **Simple** from **Operation - Advanced** in the Configuration menu, you cannot set the remote control ID.
  - ☛ "Extended Menu" p.122
- IDs are ignored when the **projector ID** is set to **Off** or the remote control ID is set to **0**.

## Setting the projector ID

- 1 Press the [Menu] button while projecting.
- 2 Select **Multi-Projection** from **Extended**.
- 3 Select **Projector ID**, and then press the [↵] button.

- 4 Select the ID you want to set, and then press the [↵] button.

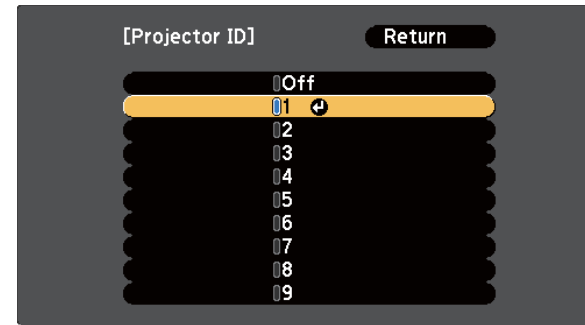

- 5 Press the [Menu] button to close the Configuration menu.

## Checking the projector ID

During projection, press the [Help] button while holding down the [ID] button.

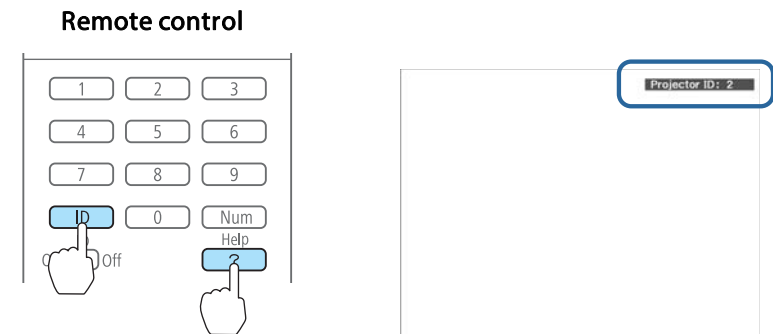

When you press the buttons, the current projector ID is displayed on the projection screen. It closes after about three seconds.

## Setting the remote control ID

- 1 Set the remote control [ID] switch to On.

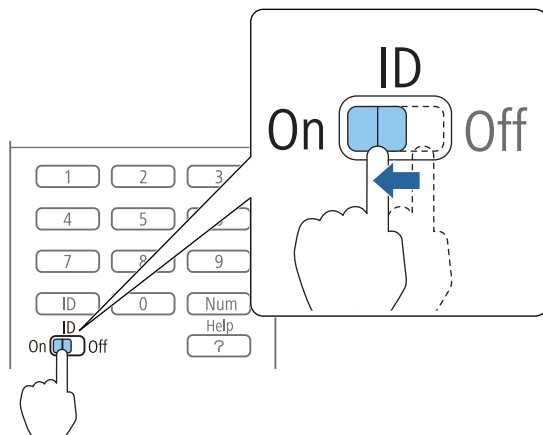

- 2 While holding down the [ID] button, press the number of the ID for the ID of the projector you want to operate.

☛ "Checking the projector ID" [p.39](#)

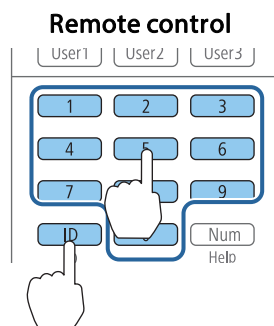

Once this setting has been made, the projector that can be operated by the remote control is limited.



The remote control ID setting is saved in the remote control. Even if the remote control batteries are removed to replace them and so on, the stored ID setting is retained. However, if the batteries are left out for a long time, it is reset to the default value (ID0).



The port name, location, and connector orientation differ depending on the source being connected.

## Connecting a Computer

To project images from a computer, connect the computer using one of the following methods.

- 1 **When using the supplied computer cable**  
Connect the computer's display output port to the projector's Computer input port.
- 2 **When using a commercially available 5BNC cable**  
Connect the computer's display output port to the projector's BNC input port.
- 3 **When using a commercially available HDMI cable**  
Connect the HDMI port on the computer to the projector's HDMI input port.
- 4 **When using a commercially available DVI-D cable**  
Connect the DVI-D port on the computer to the projector's DVI-D input port.

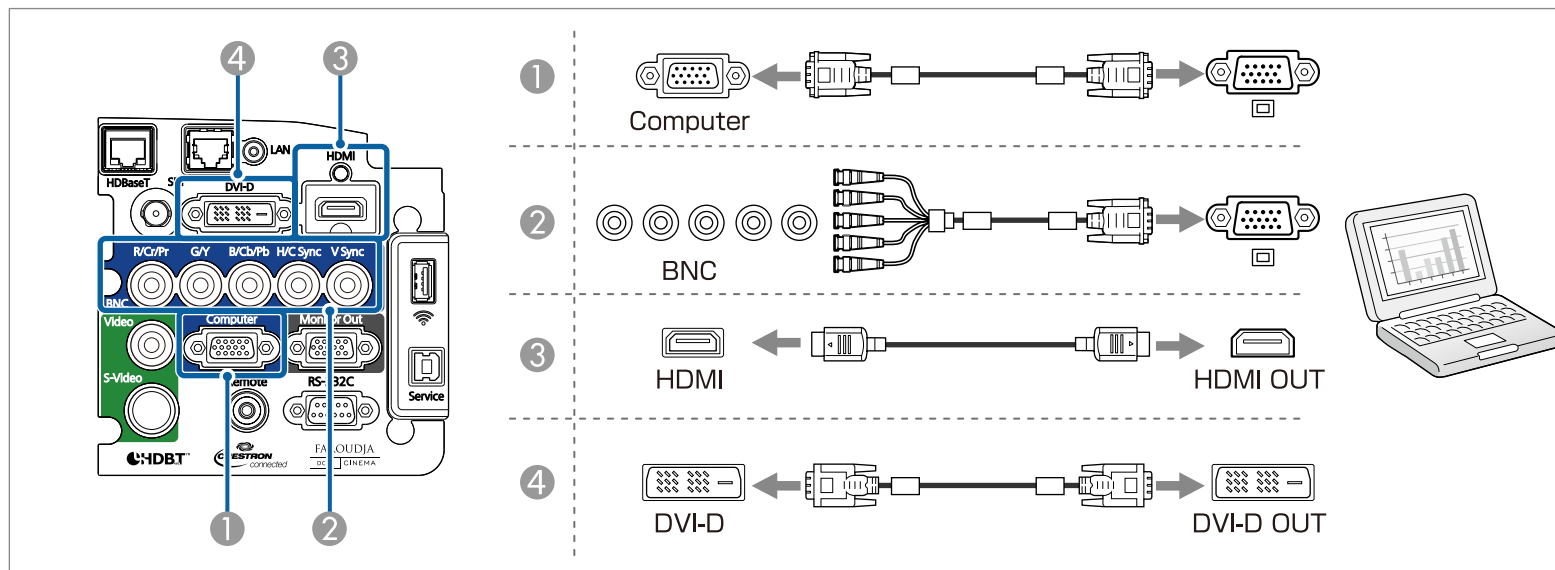

## Connecting Image Sources

To project video images, connect the computer using one of the following methods.

- ① **When using a commercially available BNC video cable (composite input)**  
Connect the video output port on the image source to the projector's Video input port.
- ② **When using a commercially available RCA video cable**  
Use a commercially available BNC/RCA adapter and connect the video output port on the image source to the projector's Video input port.
- ③ **When using a commercially available S-video cable**  
Connect the S-video output port on the image source to the projector's S-Video input port.
- ④ **When using an optional component video cable (D-sub/component converter)**  
☞ "Optional Accessories" [p.198](#)  
Connect the component output port on the image source to the projector's Computer input port.
- ⑤ **When using a commercially available component video cable (RCA) and BNC/RCA adapters**  
Connect the component output port on the video equipment to the projector's BNC input port (R/Cr/Pr, G/Y, B/Cb/Pb).
- ⑥ **When using a commercially available HDMI cable**  
Connect the HDMI port on the image source to the projector's HDMI input port.
- ⑦ **When using a commercially available BNC video cable (SDI input, EB-Z10005U/EB-Z10000U/EB-Z9875U/EB-Z9870U only)**  
Connect the SDI port on the image source to the projector's SDI input port.

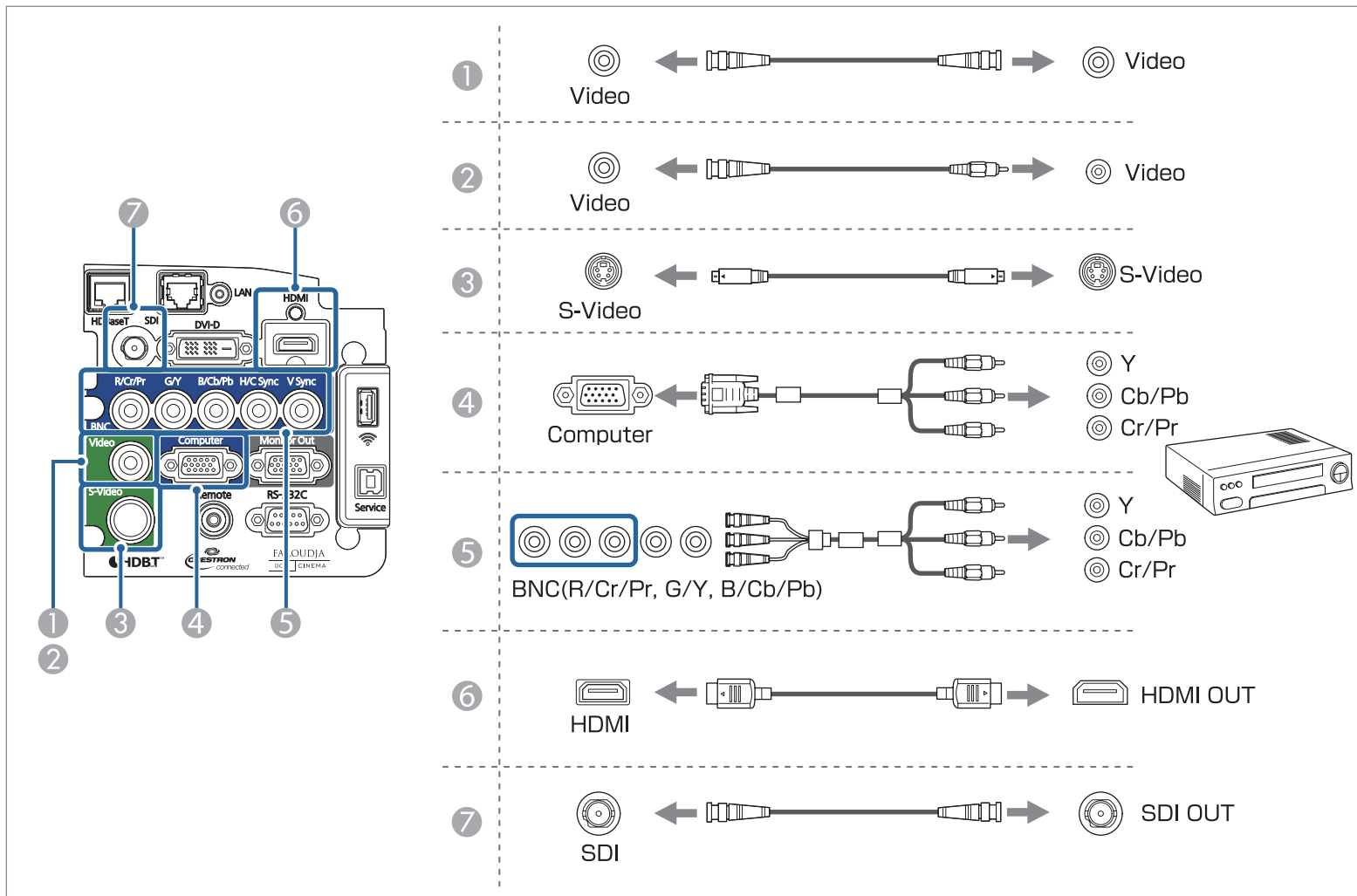

### Attention

- If you connect it to the projector when the input source is on, it could cause a malfunction.
- If the orientation or shape of the plug differs, do not try to force it in. The device could be damaged or could malfunction.



If the source you want to connect to has an unusually shaped port, use the cable supplied with the device or an optional cable to connect to the projector.

## Connecting to an External Monitor

Connect the external monitor to the projector's Monitor Out port using the cable supplied with the external monitor.

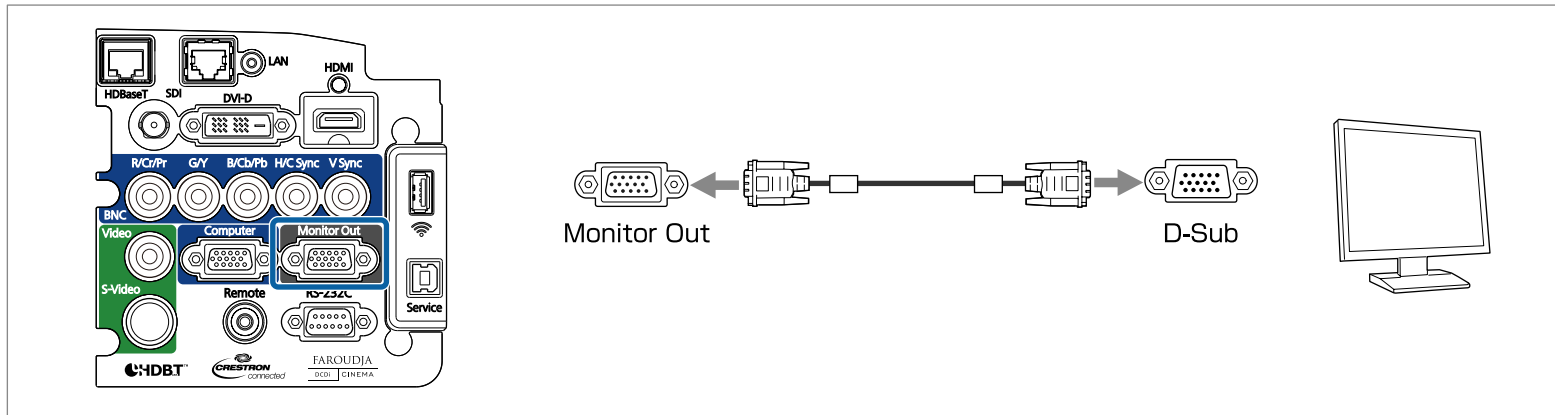

- Make the following settings to output image even when the projector is in standby mode.
  - Set **Standby Mode** to **Communication On**.
  - ☛ **Extended - Standby Mode** [p.122](#)
  - Set **A/V Output** to **Always On**.
  - ☛ **Extended - A/V Settings - A/V Output** [p.122](#)
- Only analog RGB signals from the Computer input port or BNC input port can be output to an external monitor. You can set which signals to output in **Monitor Out**.
  - ☛ **Extended - A/V Output - Monitor Out** [p.122](#)

## Connecting a LAN Cable

Connect a LAN port on network hubs or other equipment to the projector's LAN port with a commercially available 100BASE-TX or 10BASE-T LAN cable.

By connecting a computer to the projector over a network, you can project images and check the status of the projector.

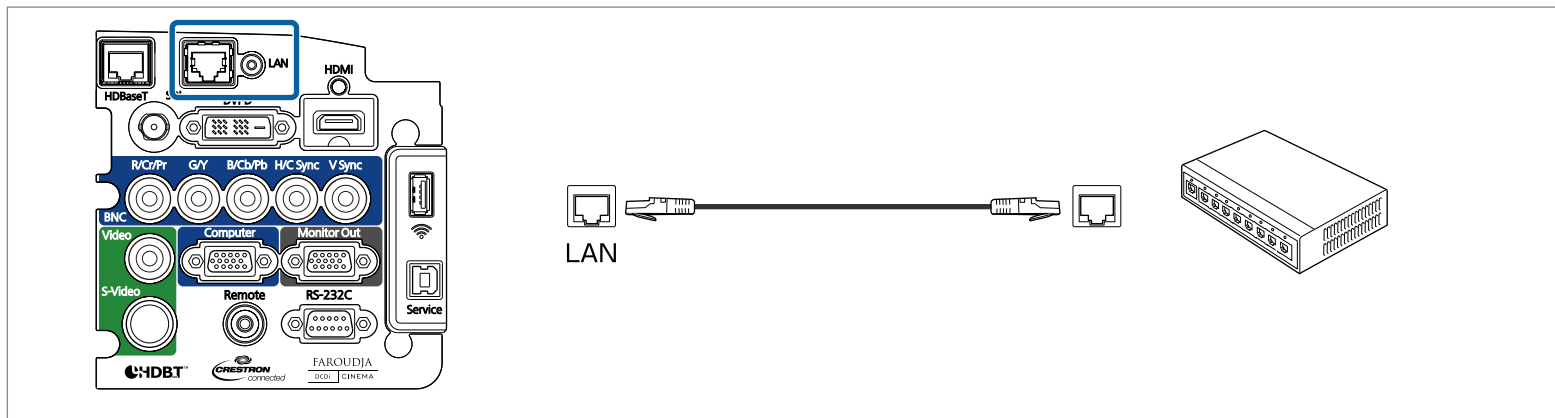

To prevent malfunctions, use a category 5 or higher shielded LAN cable.

## Connecting an HDBaseT Transmitter

Connect the optional HDBaseT transmitter with a commercially available 100BASE-TX LAN cable.

☛ "Optional Accessories" [p.198](#)

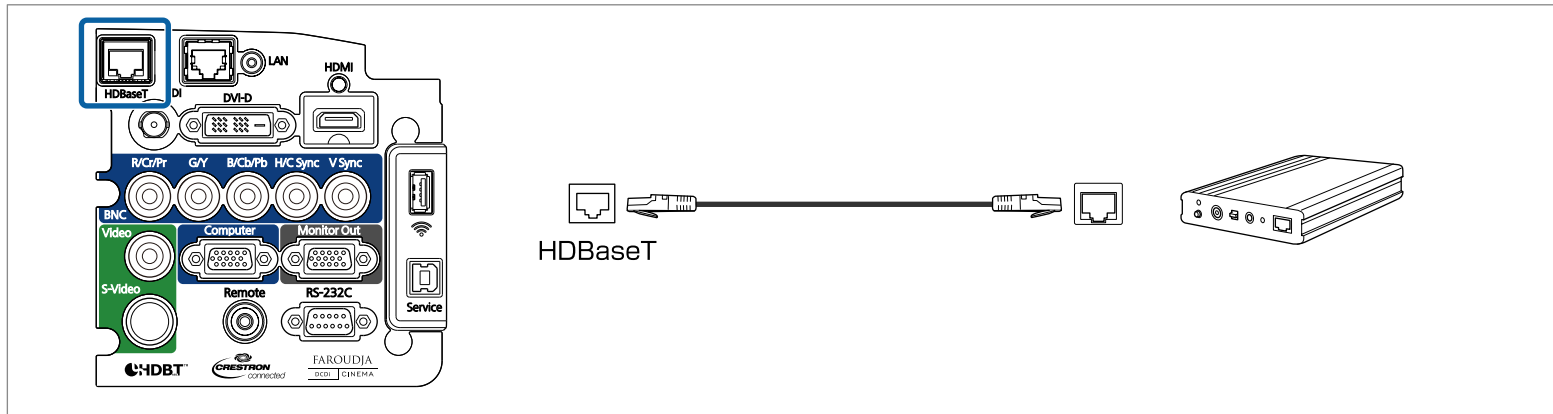

- Make sure you read the User's Guide supplied with the HDBaseT transmitter carefully before use.
- Use a category 5e or category 6 shielded LAN cable.
- When connecting or disconnecting the LAN cable, make sure you turn off the power for the projector and the HDBaseT transmitter.
- When performing Ethernet communication or serial communication, or when using the wired remote control via HDBaseT port, set **Control Communications** to **On** in the Configuration menu.
  - ☛ **Extended - HDBaseT - Control Communications** [p.122](#)

Note that when **Control Communications** is set to **On**, the projector's LAN port, RS-232C port, and Remote port are disabled.
- When using the Extron XTP transmitter or switcher, connect to the projector's HDBaseT port. Set **Extron XTP** to **On** (**Standby Mode** and **Control Communications** are automatically set to **On**).
  - ☛ **Extended - HDBaseT - Extron XTP** [p.122](#)

## Installing the Wireless LAN Unit (ELPAP07)

**1** Remove the interface cover.

☛ "Attaching and Removing the Interface Cover" [p.28](#)

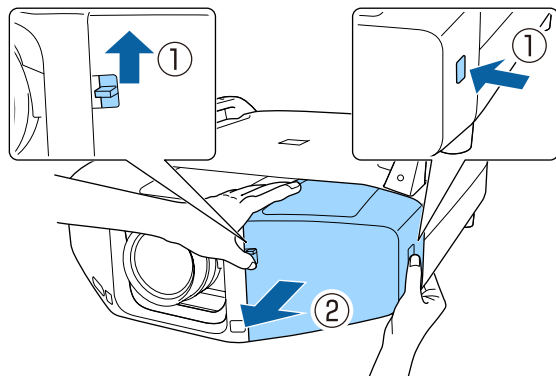

**2** Install the wireless LAN unit.

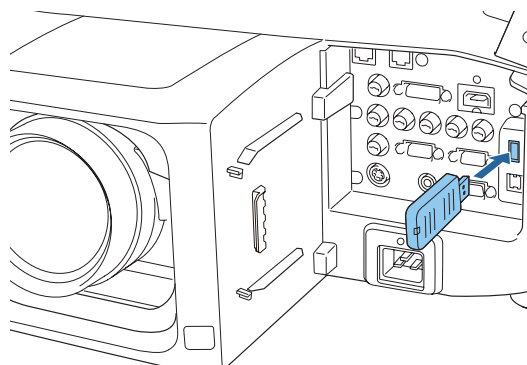

When connecting a projector to which the wireless LAN unit is attached to a computer using a wireless LAN, set the **Wireless LAN Power** setting in the **wireless LAN** menu to **On**. (The default setting is **On**.)

☛ "Wireless LAN Menu" [p.130](#)

## Using the Quick Wireless Connection USB Key

Connect the optional Quick Wireless Connection USB Key to the wireless LAN unit installation section. Check the following points when connecting a computer to the projector using wireless LAN.

- The wireless LAN unit (ELPAP07) is connected to the projector.
- The projector is setup to connect to the network using wireless LAN.
  - ☛ "Wireless LAN Menu" [p.130](#)

- 1** Turn on the projector, and then press the [LAN] button.  
The following screen is displayed.

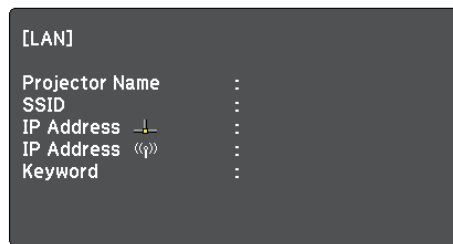

- 2** Check that the SSID and IP address information are displayed, and then remove the wireless LAN unit.
  - ☛ "Installing the Wireless LAN Unit (ELPAP07)" [p.47](#)

- 3** Insert the Quick Wireless Connection USB Key in the wireless LAN unit installation section.

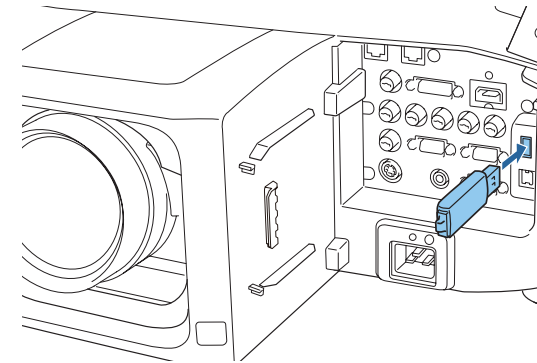

- 4** When the message "Network information update complete. Remove the Quick Wireless Connection USB Key Adapter." is displayed, remove the Quick Wireless Connection USB Key.  
After removing the Quick Wireless Connection USB Key, reattach the wireless LAN unit.
- 5** Connect the Quick Wireless Connection USB Key to the computer.  
From this point on, see the user's guide supplied with the Quick Wireless Connection USB Key.



Once the Configuration menu content has been set for one projector, you can use it to perform batch setup for multiple projectors (batch setup function). The batch setup function is only for projectors with the same model number.

Use one of the following methods.

- Setup using a USB flash drive.
- Setup by connecting the computer and projector with a USB cable.
- Setup using EasyMP Network Updater.

This manual explains the USB flash drive and the USB cable methods.



- The following content is not reflected by the batch setup function.
  - The Network menu settings (except for the Mail menu and the Others menu)
  - Lamp Hours and Status in the Info menu
- Perform batch setup before adjusting the projected image. Adjustment values for the projected image, such as Geometric Correction are reflected by the batch setup function. If batch setup is performed after adjusting the projected image, the adjustments you made may change.
- By using the batch setup function, the registered User's Logo is set for the other projectors. Do not register confidential information and so on as the User's Logo.



## Caution

Performing batch setup is the customers responsibility. If batch setup fails due to a power failure, communication error, and so on, the customer is responsible for any repair costs incurred.

## Setup Using a USB flash drive

This section explains how to perform batch setup using a USB flash drive.



- Use a FAT format USB flash drive.
- The batch setup function cannot be used by USB flash drives that incorporate security functions. Use a USB flash drive that does not incorporate security functions.
- The batch setup function cannot be used by USB card readers or USB hard disks.

## Saving settings to the USB flash drive

- 1** Disconnect the power cord from the projector, and check that all of the projector's indicators have turned off.
- 2** Connect the USB flash drive to the projector's wireless LAN unit port.

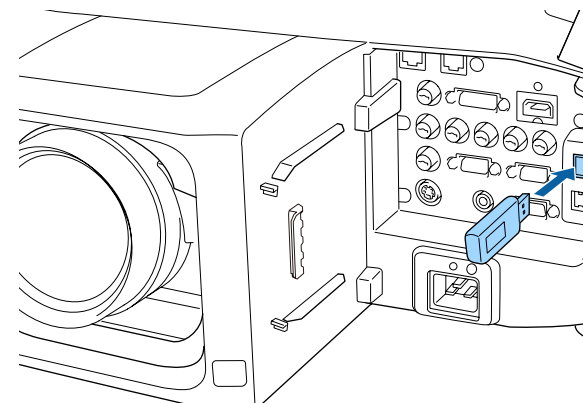



- Connect the USB flash drive directly to the projector. If the USB flash drive is connected to the projector through a USB hub, the settings may not be saved correctly.
- Connect an empty USB flash drive. If the USB flash drive contains data other than the batch setup file, the settings may not be saved correctly.
- If you have saved a batch setup file from another projector to the USB flash drive, delete the file or change the file name. The batch setup function cannot overwrite a batch setup file.
- The file name for the batch setup file is PJCONFDATA.bin. If you need to change the file name, add text after PJCONFDATA. If you change the file name in any other way, the projector may not be able to recognize the file correctly.
- You can only use single-byte characters for the file name.

**3** While holding down the [Esc] button on the remote control or the control panel, connect the power cord to the projector.

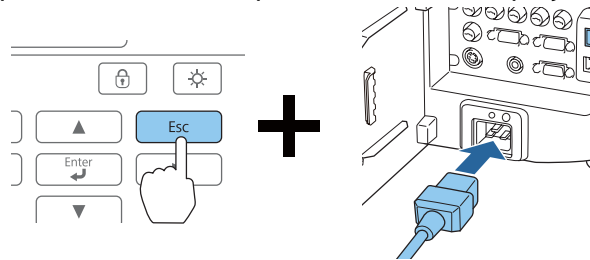

When the projector's indicators turn on as follows, release the [Esc] button.

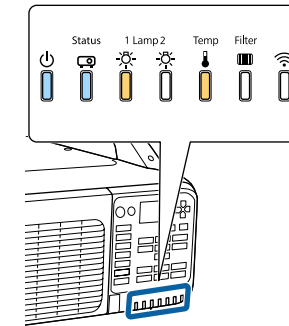

Power	Status	Lamp1	Temp
Blue - On	Blue - On	Orange - On	Orange - On

When all of the indicators start flashing, the batch setup file is being written.

### **Caution**

- Do not disconnect the power cord from the projector while the file is being written. If the power cord is disconnected, the projector may not start correctly.
- Do not disconnect the USB flash drive from the projector while the file is being written. If the USB flash drive is disconnected, the projector may not start correctly.

When writing completes normally, the projector enters standby status.

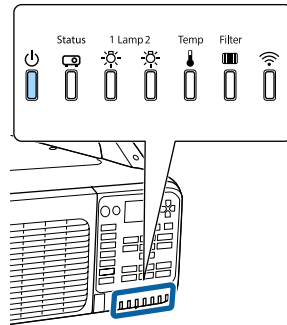

Power  
Blue - On

When the projector is in standby status, remove the USB flash drive.

## Reflecting saved settings to other projectors

- 1** Disconnect the power cord from the projector, and check that all of the projector's indicators have turned off.
- 2** Connect the USB flash drive containing the saved batch setup file to the projector's wireless LAN unit port.

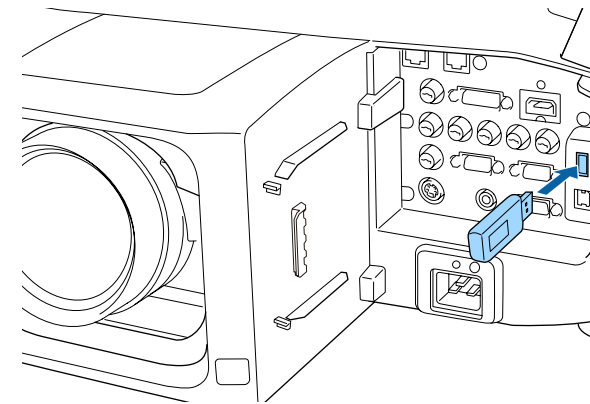

- When the USB flash drive contains 1 to 3 types of batch setup files, the file is reflected to the projector with the same model number. If there are multiple files for a projector with the same model number, the settings may not be reflected correctly.
- When there are four or more types of batch setup files on the USB flash drive, the settings may not be reflected correctly.
- Do not store any data except for the batch setup file on the USB flash drive. If the USB flash drive contains data other than the batch setup file, the settings may not be reflected correctly.

- 3** While holding down the [Menu] on the remote control or the control panel, connect the power cord to the projector.

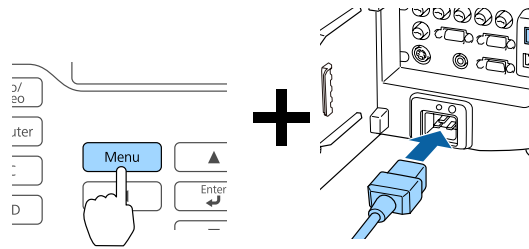

When the projector's indicators turn on as follows, release the [Menu] button.

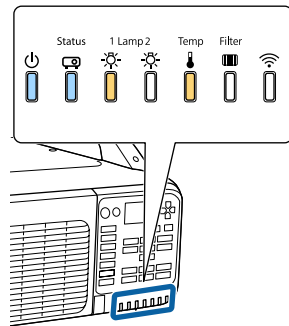

Power	Status	Lamp1	Temp
Blue - On	Blue - On	Orange - On	Orange - On

The indicators remain on for about 75 seconds.  
When all of the indicators start flashing, the settings are being written.

**Caution**

- Do not disconnect the power cord from the projector while the settings are being written. If the power cord is disconnected, the projector may not start correctly.
- Do not disconnect the USB flash drive from the projector while the settings are being written. If the USB flash drive is disconnected, the projector may not start correctly.

- 4** When writing completes normally, the projector enters standby status.

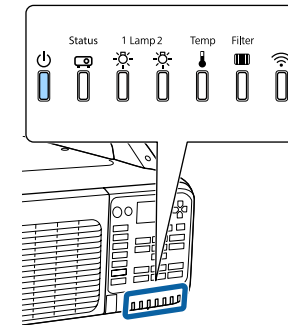

Power  
Blue - On

When the projector is in standby status, remove the USB flash drive.

## Setup by Connecting the Computer and Projector with a USB Cable



The following operating systems support the batch setup function.

- Windows Vista and later
- Mac OS X 10.5.3 and later

### Saving settings to a computer

- 1 Disconnect the power cord from the projector, and check that all of the projector's indicators have turned off.
- 2 Connect the computer's USB port to the projector's Service port with a USB cable.

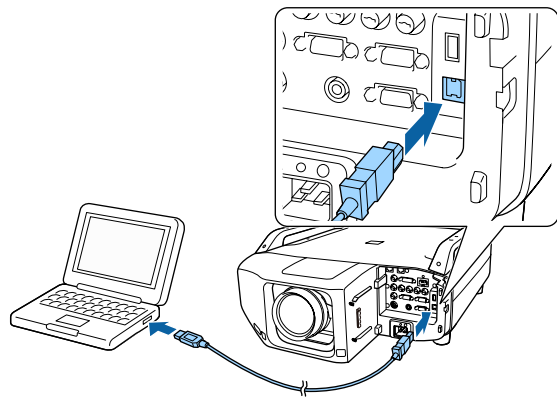

- 3 While holding down the [Esc] button on the remote control or the control panel, connect the power cord to the projector.

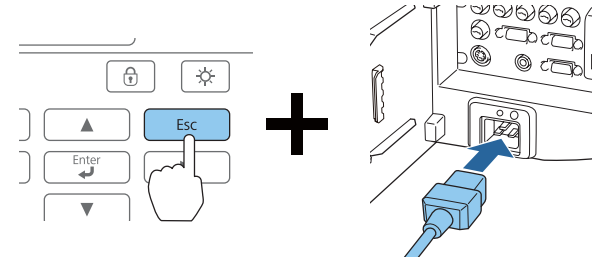

When all of the projector's indicators turn on, release the [Esc] button.

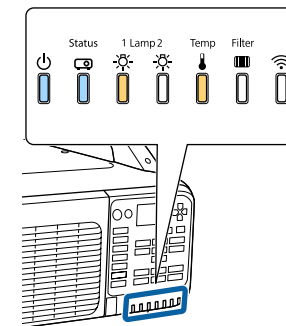

Power	Status	Lamp1	Temp
Blue - On	Blue - On	Orange - On	Orange - On

The projector is recognized as a removable disk by the computer.

- 4 Open the removable disk, and save the batch setup file (PJCONFDATA.bin) to the computer.



If you need to change the name of the batch setup file, add text after PJCONFDATA. If you change the PJCONFDATA section of the file name, the projector may not be able to recognize the file correctly.

- 5 Perform "Remove USB device" on your computer, and then disconnect the USB cable.



When using OS X, perform "Remove EPSON\_PJ".

The projector enters standby status.

## Reflecting saved settings to other projectors

- 1 Disconnect the power cord from the projector, and check that all of the projector's indicators have turned off.
- 2 Connect the computer's USB port to the projector's Service port with a USB cable.

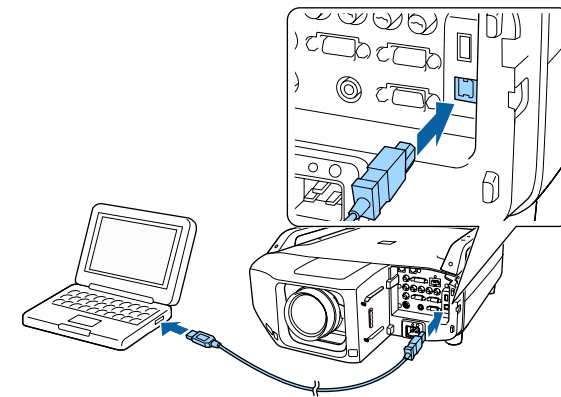

- 3 While holding down the [Menu] on the remote control or the control panel, connect the power cord to the projector.

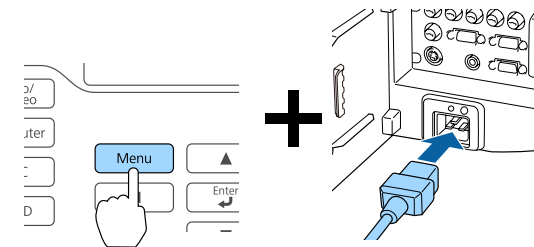

When the projector's indicators turn on as follows, release the [Menu] button.

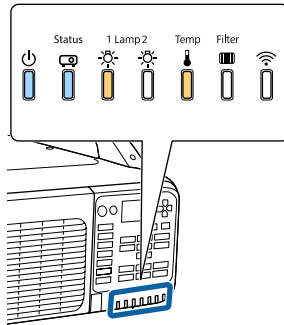

Power	Status	Lamp1	Temp
Blue - On	Blue - On	Orange - On	Orange - On

The projector is recognized as a removable disk by the computer.

- 4 Copy the batch setup file (PJCONFDATA.bin) that you saved to your computer to the top level folder of the removable disk.



Do not copy any files or folders other than the batch setup file to the removable disk.

- 5 Perform "Remove USB device" on your computer, and then disconnect the USB cable.



When using OS X, perform "Remove EPSON\_PJ".

When all of the indicators start flashing, the settings are being written.

### **Caution**

Do not disconnect the power cord from the projector while the settings are being written. If the power cord is disconnected, the projector may not start correctly.

When writing completes normally, the projector enters standby status.

## When Setup Fails

The indicators notify you if an error occurs. Check the status of the indicators.

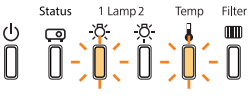
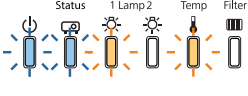
Status of the Indicators	Remedy
 <p>Lamp1: Orange - flashing fast Temp: Orange - flashing fast</p>	<p>The batch setup file may be corrupt, or the USB flash drive or USB cable may not be connected correctly. Disconnect the USB flash drive or the USB cable, unplug and then plug in the projector's power cord, and then try again.</p>
 <p>Power: Blue - flashing fast Status: Blue - flashing fast Lamp1: Orange - flashing fast Temp: Orange - flashing fast</p>	<p>Writing the settings may have failed and an error may have occurred in the projector's firmware. Stop using the projector, remove the power cord from the electrical outlet, and contact your local dealer or the nearest address provided in the Epson Projector Contact List.  <a href="#">👉 Epson Projector Contact List</a></p>





## Basic Usage

This chapter explains how to project and adjust images.

## Automatically Detect Input Signals and Change the Projected Image (Search)

Press the [Search] button on the remote control to project images from the port currently receiving an image.

Remote control

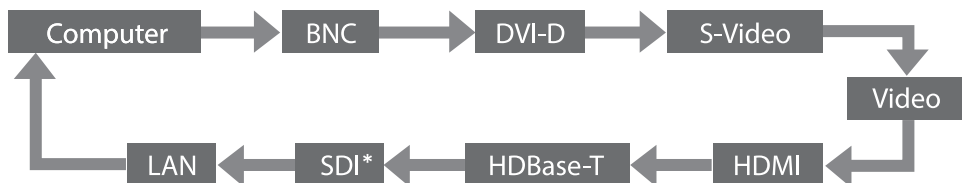
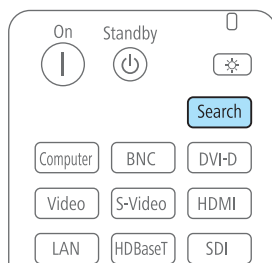

\* For EB-Z10005U/EB-Z10000U/EB-Z9875U/EB-Z9870U only

When multiple devices are connected, press the [Search] button on the remote control until the target image is projected.

When video equipment is connected, make sure that the equipment is ready to play, and then start this operation.



- You can make settings so that images are projected from the same input port the next time the projector is turned on.
  - Extended - Operation - Startup Source Search [p.122](#)
- The following screen is displayed while no image signals are input.

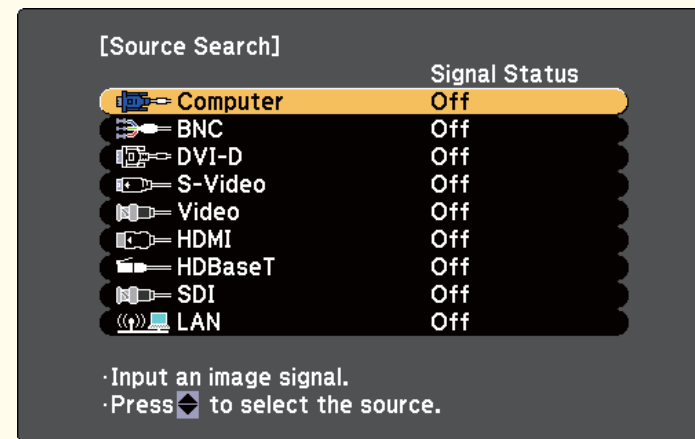

[]:Select []:Enter [Esc]:Exit

## Switching to the Target Image

You can change directly to the target image from the remote control or by pressing the following buttons on the control panel.

The following shows the input ports for each button.

### Remote control

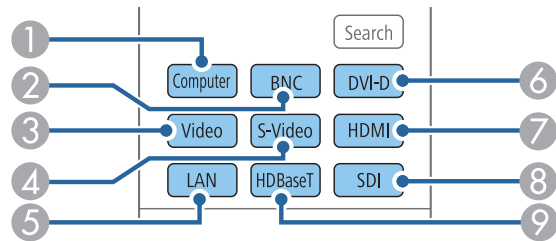

### Control panel

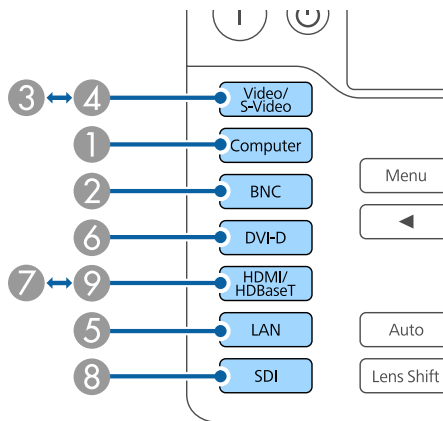

### Input ports

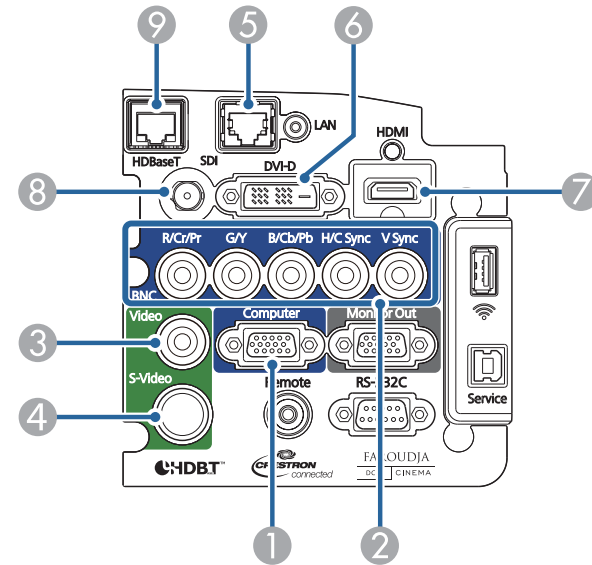

- 5 Changes to images from a computer connected over the network.
- 8 For EB-Z10005U/EB-Z10000U/EB-Z9875U/EB-Z9870U only

## Correcting Distortion in the Projected Image

You can correct keystone distortion in projected images using one of the following methods.

- H/V-Keystone  
Manually correct keystone distortion in the horizontal and vertical directions independently.  
☛ "H/V-Keystone" p.61

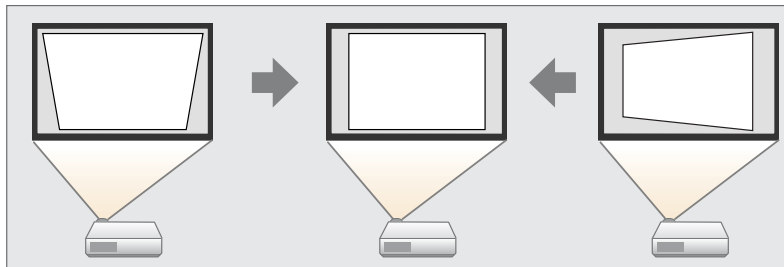

- Quick Corner  
Manually correct the four corners independently.  
☛ "Quick Corner" p.62

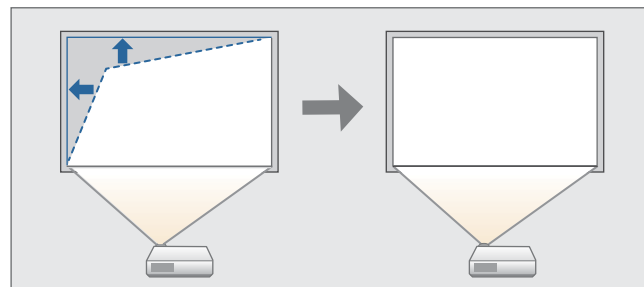

- Curved Surface  
Manually correct distortion that occurs when projecting on a curved surface, and adjust the amount of expansion and contraction.  
☛ "Curved Surface" p.63

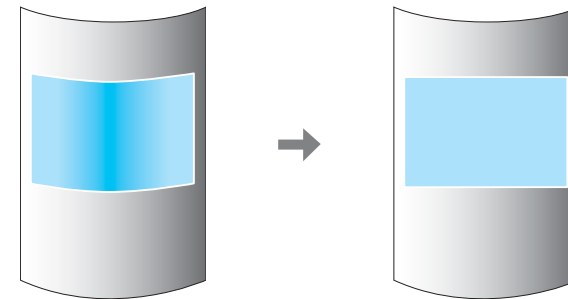

- Point Correction  
Corrects slight distortion which occurs partially, or adjusts the image position in an overlapping area when projecting from multiple projectors.  
☛ "Point Correction" p.65

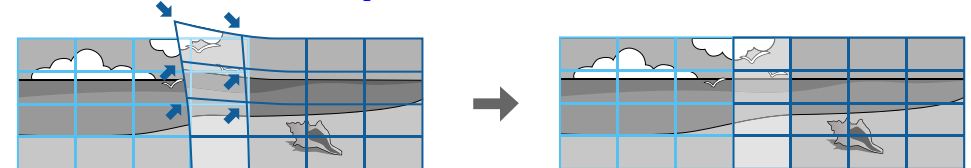

- Corner Wall  
Manually correct distortion that occurs when projecting on a surface with right angles, such as a square pillar or the corner of a room, and adjust the amount of expansion and contraction.  
☛ "Corner Wall" p.67

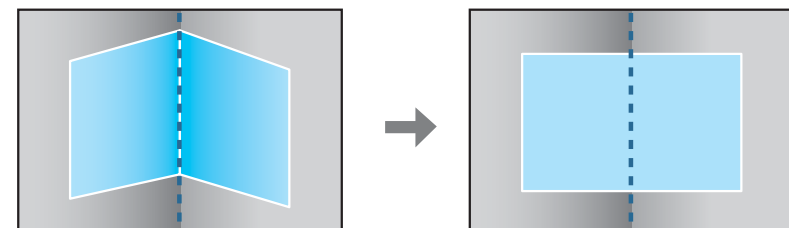









- You cannot combine multiple adjustment methods. However, you can use Point Correction after performing Curved Surface or Corner Wall.
- When you want to re-adjust the projection position and so on, if you want to release the correction status temporarily, set the **Geometric Correction** to **Off**. Even when it is set to **Off**, the correction values are saved.
-  **Settings - Geometric Correction** p.121

## H/V-Keystone

Manually correct keystone distortion in the horizontal and vertical directions independently. The angle of vertical and horizontal tilt for the projector can be corrected up to 30 degrees against the screen. (The specifications are when a standard zoom lens ELPLS04 is attached).

- Press the [Menu] button while projecting.
- Select **Geometric Correction** from **Settings**.
- Select **H/V-Keystone**, and then press the [] button.  
When the message "If this setting is changed, the image may be distorted." is displayed, press the [] button.

- Press the [][] buttons to select the correction method, and then use the [][] buttons to make the corrections.

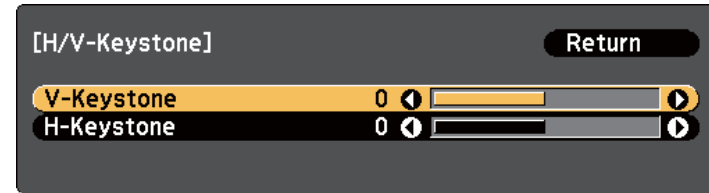

[Esc] :Return [◆]:Select []:Adjust [Menu]:Exit  
[Default] :Reset

V-Keystone

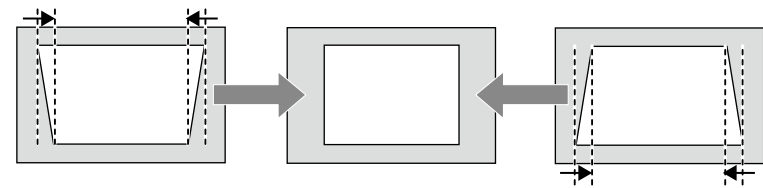

H-Keystone

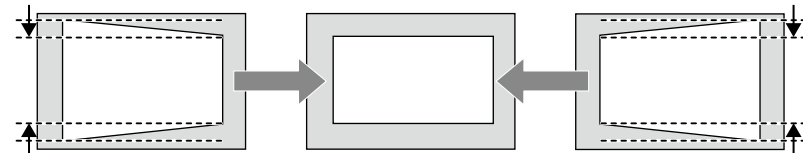

When you correct keystone distortion, the projected image may be reduced.

- To complete the corrections, press the [Menu] button.

## Quick Corner

This allows you to manually correct each of the four corners of the projected image separately.

- 1** Press the [Menu] button while projecting.
- 2** Select **Geometric Correction** from **Settings**.
- 3** Select **Quick Corner**, and then press the [↵] button.  
When the message "If this setting is changed, the image may be distorted." is displayed, press the [↵] button again.
- 4** Press the [▲][▼][◀][▶] buttons to select the corner you want to adjust, and then press the [↵] button.

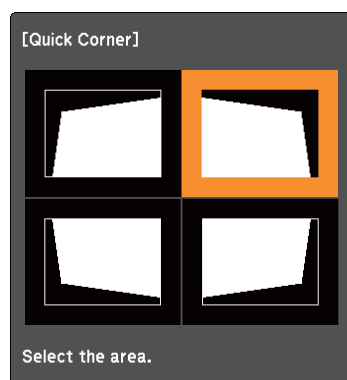

[◀/▶]: Select  
 [↵]: Enter  
 [Esc]: Return (press for 2 seconds to reset/switch)



If the [Esc] button is pressed for approximately two seconds, the confirm default reset screen is displayed.

Select **Yes** to reset the result of Quick Corner corrections.

- 5** Press the [▲][▼][◀][▶] buttons to correct the position of the corner.

When you press the [↵] button, the screen shown in step 4 that allows you to select the area to be corrected is displayed.

If the message "Cannot adjust any further." is displayed while adjusting, you cannot adjust the shape any further in the direction indicated by the gray triangle.

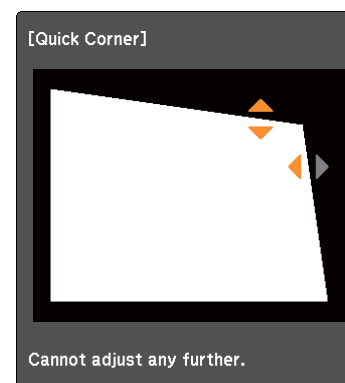

[◀/▶]: Adjust  
 [Esc]/[↵]: Return

- 6** Repeat steps 4 and 5 as needed to adjust any remaining corners.
- 7** When the corrections are complete, press the [Menu] button.

## Curved Surface

Manually correct distortion that occurs when projecting on a curved surface, and adjust the amount of expansion and contraction.

Project from the front with the horizontal lens shift in the center.

☛ "Adjusting the Position of the Projected Image (Lens shift)" p.35



- Project onto an arc surface with the same radius.
- If a large amount of adjustment is performed, the focus may not be uniform even after making adjustments.

### Correction method

- 1 Press the [Menu] button while projecting.
- 2 Select **Geometric Correction** from **Settings**.
- 3 Select **Curved Surface**, and then press the [↵] button.  
When the message "If this setting is changed, the image may be distorted." is displayed, press the [↵] button.
- 4 Select **Correct Shape**, and then press the [↵] button.

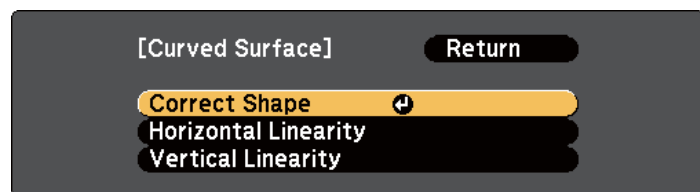

[Esc]:Return [↩]:Select [↵]:Enter [Menu]:Exit

- 5 Press the [▲][▼][◀][▶] buttons to select the area you want to adjust, and then press the [↵] button.

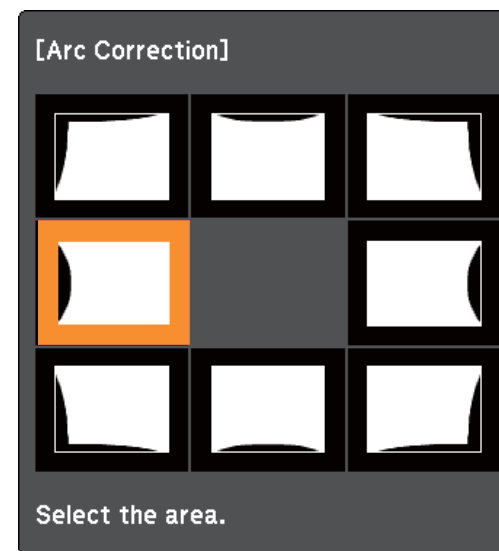

When selecting a corner, you can adjust the two sides next to the corner.



- If the [Esc] button is pressed for approximately two seconds, the confirm default reset screen is displayed.  
Select **Yes** to reset the result of Curved Surface.

- 6** Press the [▲][▼][◀][▶] buttons to adjust the position of the sides.

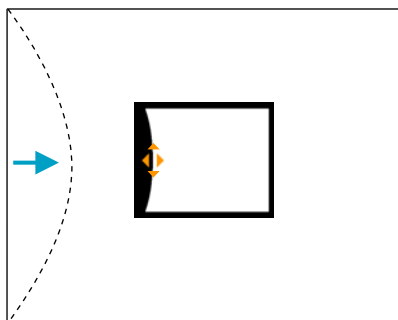

If the triangle in the direction you are adjusting the shape turns gray, as shown in the screen shot below, you cannot adjust the shape any further in that direction.

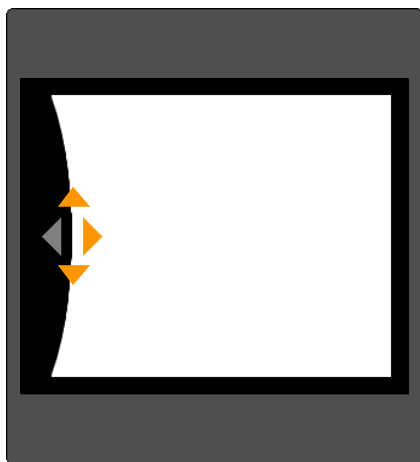

- 7** Press the [Esc] button to return to the previous screen.
- 8** Repeat steps 5 to 7 as needed to adjust any remaining parts.  
If the image expands and contracts, go to the next step and adjust the linearity.

- 9** Press the [Esc] button to return to the screen in step 4. Select **Horizontal Linearity** or **Vertical Linearity**, and then press the [↵] button.

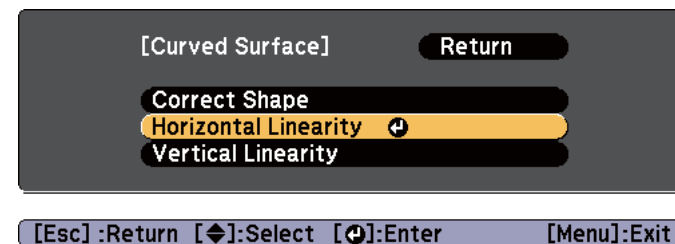

Select **Horizontal Linearity** to adjust the horizontal expansion or contraction, and select **Vertical Linearity** to adjust the vertical expansion or contraction.

- 10** Select the standard line for the adjustments, and then press the [↵] button.

Press the [◀][▶] buttons when selecting **Horizontal Linearity**, and the [▲][▼] buttons when selecting **Vertical Linearity**, and then press the [↵] button.

The selected standard line is displayed in flashing orange and white.



- 11** Adjust the linearity.  
Correct it so that the distance between lines is equal.  
When the [◀] button is pressed

Selecting **Horizontal Linearity**

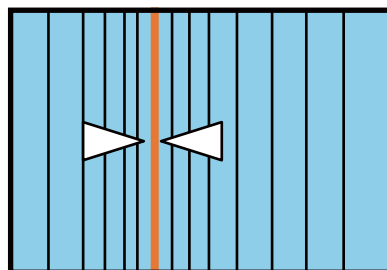

Selecting **Vertical Linearity**

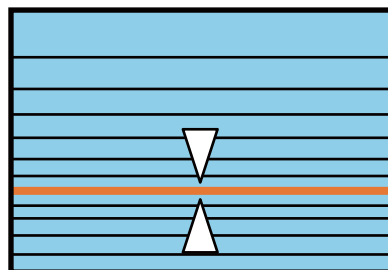

When the [▶] button is pressed

Selecting **Horizontal Linearity**

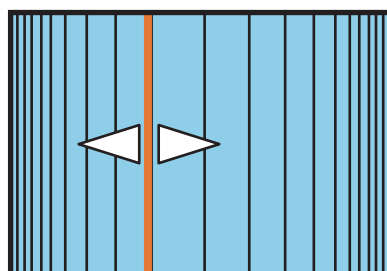

Selecting **Vertical Linearity**

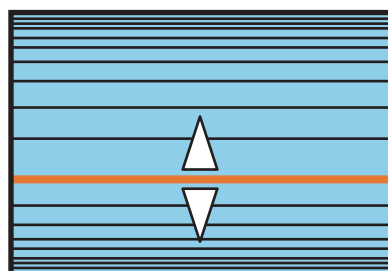

- 12** To complete the corrections, press the [Menu] button.



You can fine tune the results of Curved Surface using Point Correction. Change **Geometric Correction** to **Point Correction**, and then make adjustments after selecting **Keep the current geometric correction settings**.

☛ "Point Correction" p.65

## Point Correction

Divides the projected image by the grid and corrects the distortion by moving the point of intersection from side to side and up and down.



- You can make corrections by 0.5 pixel in each direction in the following ranges.  
EB-Z10005U/EB-Z10000U/EB-Z9875U/EB-Z9870U/EB-Z9750U:  
Maximum of 48 pixels in vertical and horizontal directions  
EB-Z11000W/EB-Z9900W/EB-Z9800W/EB-Z11005/EB-Z11000/EB-Z9870:  
Maximum of 32 pixels in vertical and horizontal directions
- When fine-tuning the result of corrections you made in Curved Surface and Corner Wall, you can adjust in a maximum range of 10 pixels in vertical and horizontal directions.

- Press the [Menu] button while projecting.
- Select **Geometric Correction** from **Settings**.
- Select **Point Correction**, and then press the [↶] button.  
When the message "If this setting is changed, the image may be distorted." is displayed, press the [↶] button again.



When changing from Curved Surface or Corner Wall to Point Correction, the screen displaying the adjustment method is displayed.

**Keep the current geometric correction settings:** Use Point Correction to fine tune images adjusted using Curved Surface or Corner Wall.

**Reset the geometric correction settings:** Reset adjustments made to images using Curved Surface or Corner Wall, and then perform adjustment using Point Correction.

**4** Select **Point Correction**, and then press the [**↵**] button.

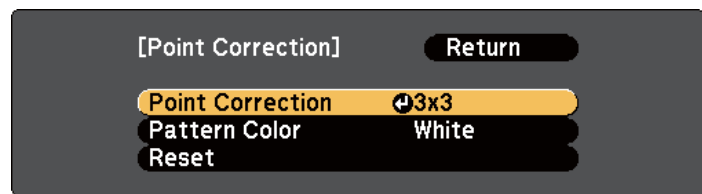

[Esc]:Return [↵]:Select [↵]:Enter [Menu]:Exit

<b>Point Correction</b>	Select the point number (3x3, 5x5, 9x9), and then make the Point Correction setting.
<b>Pattern Color</b>	Select the color of the grid when performing corrections.
<b>Reset</b>	Resets all corrections for <b>Point Correction</b> to their default values.

**5** Select the point number (3x3, 5x5, or 9x9), and then press the [**↵**] button.

**6** Press the [**▲**][**▼**][**◀**][**▶**] buttons to move to the point you want to correct, and then press the [**↵**] button.

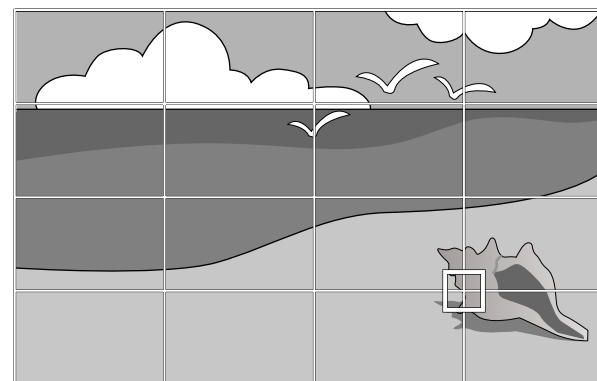

**7** Press the [**▲**][**▼**][**◀**][**▶**] buttons to correct distortion.

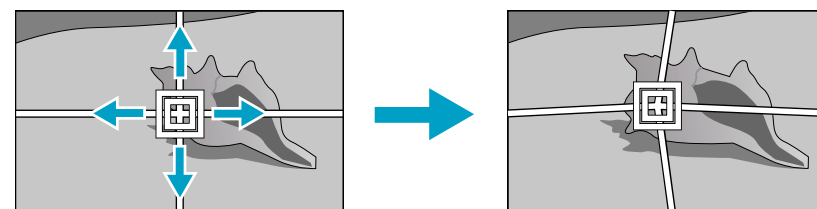

To continue to correct another point, press the [Esc] button to return to the previous screen, then repeat the step 6 and 7.



Each time you press the [**↵**] button, you can show or hide the image and the grid.

**8** To complete the corrections, press the [Menu] button.

## Corner Wall

Manually correct distortion that occurs when projecting on a surface with right angles, such as a square pillar or the corner of a room, and adjust the amount of expansion and contraction.

Project from the front with the horizontal lens shift in the center.

☛ "Adjusting the Position of the Projected Image (Lens shift)" [p.35](#)



- Project onto a surface with a right angle.
- If a large amount of adjustment is performed, the focus may not be uniform even after making adjustments.
- You may not be able to adjust Corner Wall correctly when using the short throw zoom lens ELPLU02.

## Correction method

- 1 Press the [Menu] button while projecting.
- 2 Select **Geometric Correction** from **Settings**.
- 3 Select **Corner Wall**, and then press the [↵] button.  
When the message "If this setting is changed, the image may be distorted." is displayed, press the [↵] button again.
- 4 Select **Corner Type**, and then press the [↵] button.

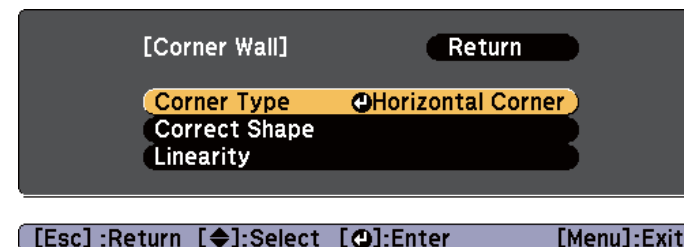

- 5** To fit the projected image to the projection position, select **Horizontal Corner** or **Vertical Corner**, and then press the [↵] button.

When the surfaces line up horizontally:  
Select **Horizontal Corner**.

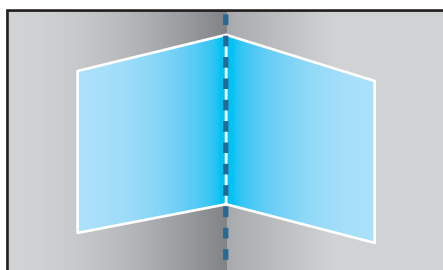

When the surfaces line up vertically:  
Select **Vertical Corner**.

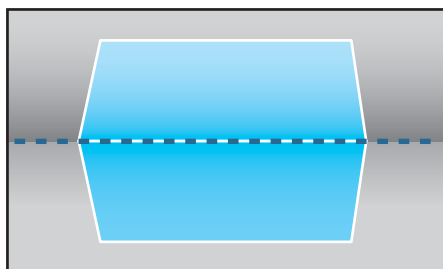

From here on, steps are explained using **Horizontal Corner** as an example.

- 6** Press the [Esc] button to display the screen from step 4. Select **Correct Shape**, and then press the [↵] button.

- 7** Adjust the position of the projector and the lens shift so that the line in the center of the screen matches the corner (the point where the two surfaces meet).

☞ "Adjusting the Position of the Projected Image (Lens shift)"  
[p.35](#)

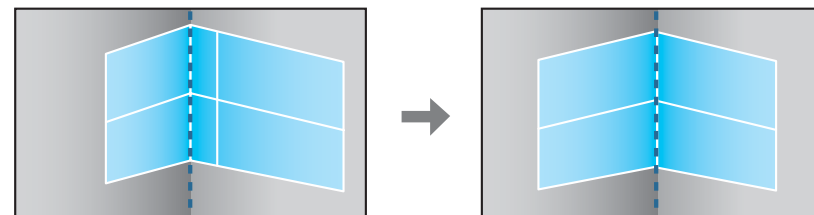

Each time you press the [↵] button, you can show or hide the image and the grid.

- 8** Press the [▲][▼][◀][▶] buttons to select the area you want to adjust, and then press the [↵] button.

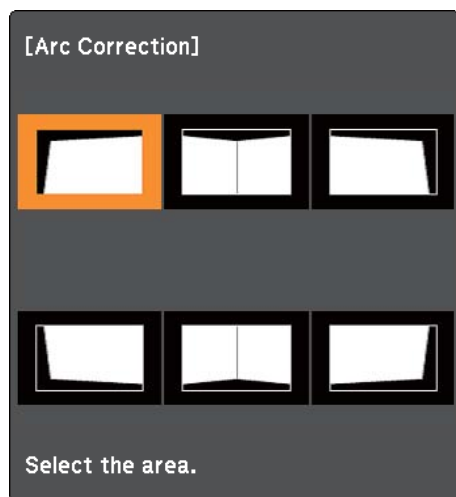

### Adjustment tips

When selecting **Horizontal Corner**:

Adjust the upper area based on the lowest point (indicated by the **A** arrow).

Adjust the lower area based on the highest point (indicated by the **B** arrow).

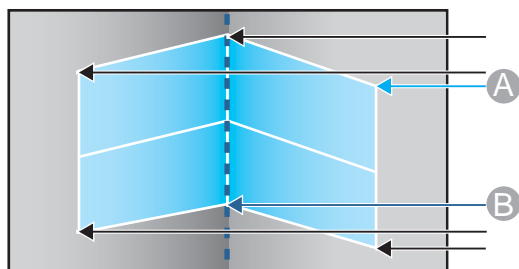

When selecting **Vertical Corner**:

Adjust the left and right based on the point nearest to the vertical line in the center of the screen.



If the [Esc] button is pressed for approximately two seconds, the confirm default reset screen is displayed.

Select **Yes** to reset the result of **Corner Wall**.

- 9** Press the [▲][▼][◀][▶] buttons to adjust the shape. If the message "Cannot adjust any further." is displayed while adjusting, you cannot adjust the shape any further in the direction indicated by the gray triangle.
- 10** Repeat steps 8 and 9 as needed to adjust any remaining parts. If the image expands and contracts, go to the next step and adjust the linearity.
- 11** Press the [Esc] button to display the screen from step 4. Select **Linearity**, and then press the [↵] button.

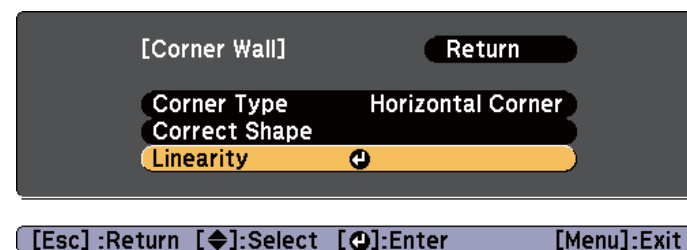

**12** Press the [◀][▶] buttons to adjust the linearity.  
Correct it so that the distance between lines is equal.

When the [◀] button is pressed

When selecting **Horizontal Corner**

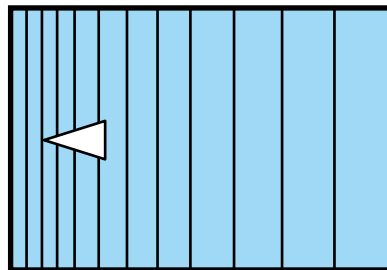

When selecting **Vertical Corner**

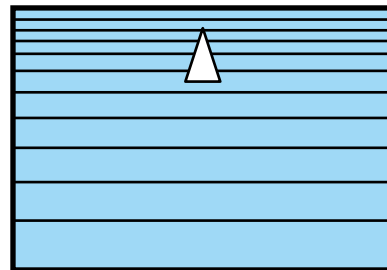

When the [▶] button is pressed

When selecting **Horizontal Corner**

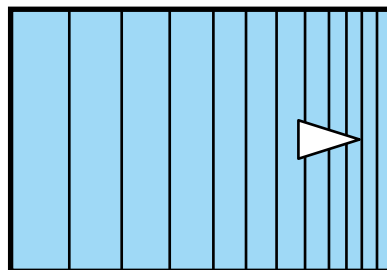

When selecting **Vertical Corner**

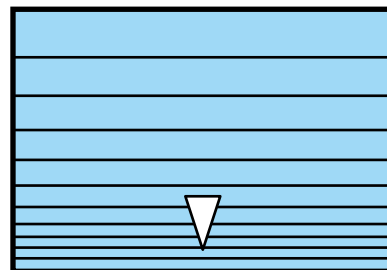

**13** To complete the corrections, press the [Menu] button.



You can fine tune the results of Corner Wall using Point Correction. Change **Geometric Correction** to **Point Correction**, and then make adjustments after selecting **Keep the current geometric correction settings**.

☞ "Point Correction" p.65

## Selecting the Projection Quality (Selecting Color Mode)

You can easily obtain the optimum image quality simply by selecting the setting that best corresponds to your surroundings when projecting. The brightness of the image varies depending on the mode selected.



Mode	Application
<b>Dynamic</b>	Ideal for use in a bright room. This is the brightest mode.
<b>Presentation</b>	Ideal for making presentations using color materials in a bright room.
<b>Theatre</b>	Ideal for watching films in a dark room. Gives images a natural tone.
<b>Photo*1</b>	Ideal for projecting still pictures, such as photos, in a bright room. The images are vivid and brought into contrast.
<b>Sports*2</b>	Ideal for watching TV programs in a bright room. The images are vivid and brought to life.
<b>sRGB</b>	Ideal for images that conform to the <b>sRGB</b> color standard.
<b>DICOM SIM*1</b>	Ideal for projecting X-ray photographs and other medical images. This produces images with clear shadows. The projector is not a medical device and cannot be used for medical diagnosis.
<b>Multi-Projection</b>	Ideal for projecting from multiple projectors. Minimize the color tone difference between each projected image.

\*1 This can only be selected when inputting RGB signals.

\*2 This selection is only available when the input signal is component video, or when the input source is Video or S-Video.

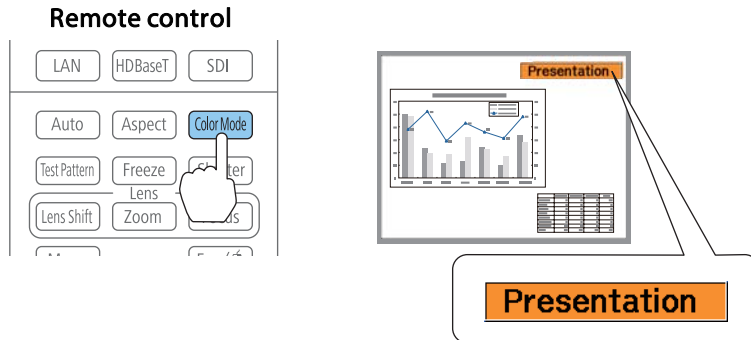
Each time you press the [Color Mode] button, the Color Mode name is displayed on the screen and the Color Mode changes.



 You can set Color Mode in the Configuration menu.  
 **Image - Color Mode** [p.117](#)

## Setting Auto Iris

By automatically setting the luminance according to the brightness of the displayed image, it lets you enjoy deep and rich images.

-  • If you keep projecting extremely dark images, Auto Iris may stop for approximately ten minutes. When you are using multiple projectors, black levels may differ depending on the projected images.
- **Auto Iris** can only be set when the **Color Mode** is set to **Dynamic** (3D Dynamic) or **Theatre** (3D Theatre).
- When **Edge Blending** is set to **On**, Auto Iris is disabled.

- 1** Press the [Menu] button while projecting.
- 2** Select **Auto Iris** from **Image**, and then press the [↵] button.

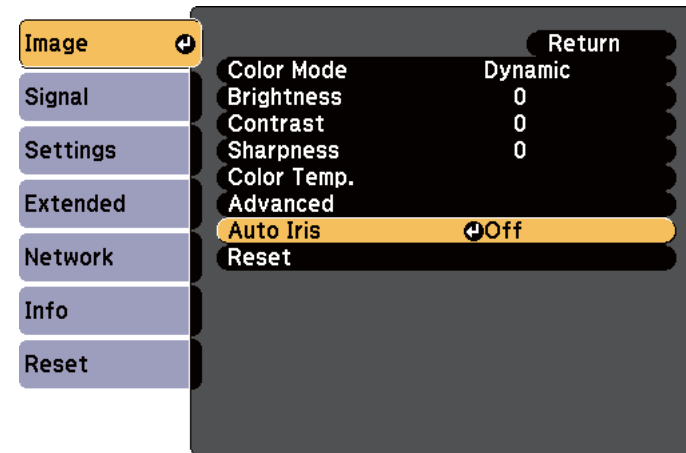



[Esc]:Return [◆]:Select [⏏]:Enter [Menu]:Exit

- 3** Select **High Speed**, and then press the [**↵**] button.  
 If you are concerned about the operation noise of Auto Iris, set it to **Normal**.  
 The setting is stored for each color mode.
- 4** Press the [Menu] button to finish making settings.

## Changing the Aspect Ratio of the Projected Image

You can change the Aspect Ratio of the projected image to suit the type, the ratio of height and width, and the resolution of the input signals.

Available aspect modes vary depending on the Screen Type currently set.

 Set the **Screen Type** before changing the aspect ratio.  
 "Screen Settings" [p.32](#)

### Changing methods

Each time you press the [Aspect] button on the remote control, the aspect mode name is displayed on the screen and the aspect ratio changes.

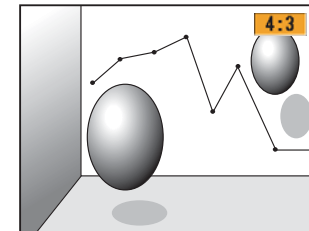
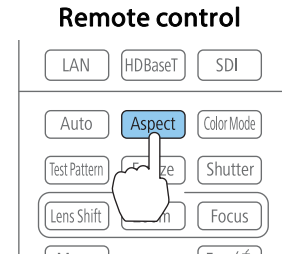

Aspect Mode	Explanation
<b>Auto</b>	Projects in an appropriate aspect ratio based on information from the signal being input.
<b>Normal</b>	Projects while retaining the aspect ratio of the input image.
<b>4:3</b>	Projects at an aspect ratio of 4:3.
<b>16:9</b>	Projects at an aspect ratio of 16:9.
<b>Full</b>	Projects at the full size of the projected screen.



Aspect Mode	Explanation
<b>Zoom</b>	Projects by enlarging the input image to the full width of the projected screen while retaining the aspect ratio. Areas that exceed the edges of the projected screen are not projected.
<b>Native</b>	Projects to the center of the projected screen at the resolution of the input image. Areas that exceed the edges of the projected screen are not projected.



- You can also set the aspect ratio in the Configuration menu.
  - ☛ **Signal - Aspect** [p.119](#)
- If parts of the computer image are missing, set the **Resolution** setting to **Wide** or **Normal** in the Configuration menu, according to the resolution of the computer.
  - ☛ **Signal - Resolution** [p.119](#)

The aspect mode changes as shown in the tables below.







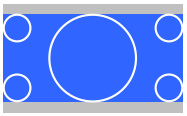
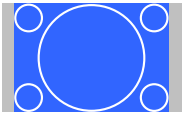
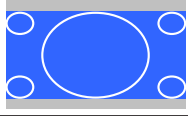
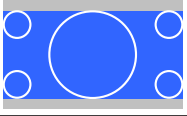
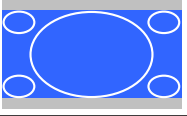

The following colors in screen images in the tables indicate areas that are not displayed.

■: The area where the image is not displayed depending on the screen type setting.

■: The area where the image is not displayed depending on the aspect mode setting.





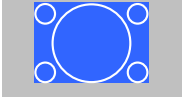

EB-Z10005U/EB-Z10000U/EB-Z9875U/EB-Z9870U/EB-Z9750U/EB-Z11000W/EB-Z9900W/EB-Z9800W

Screen type setting: 16:10

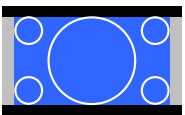
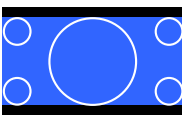
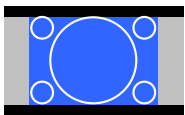
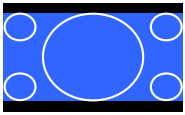
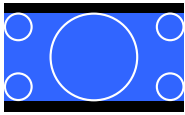
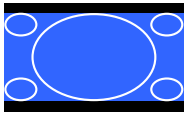
	Aspect Ratio of Input Signal		
	16:10	16:9	4:3
Auto or Normal			
16:9			
Full			
Zoom			
Native*			

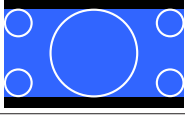





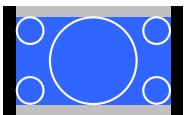

\* The image may differ depending on the resolution of the input signal.

Screen type setting: 16:9

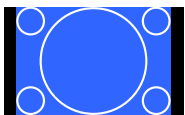
	Aspect Ratio of Input Signal		
	16:10	16:9	4:3
Auto or Normal			
Full			
Zoom			
Native*			

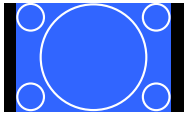
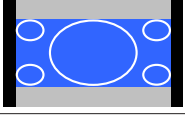
\* The image may differ depending on the resolution of the input signal.

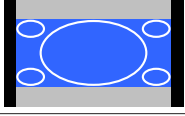

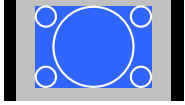
Screen type setting: 4:3

	Aspect Ratio of Input Signal		
	16:10	16:9	4:3
Auto or Normal			
4:3			
16:9			
Native*			

\* Only computer images and images from the HDMI input port/HDBaseT port. The image may differ depending on the resolution of the input signal.

EB-Z11005/EB-Z11000/EB-Z9870

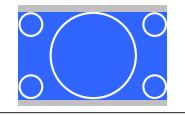
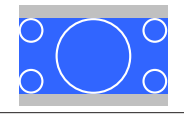
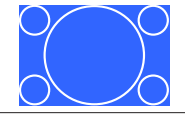
Screen type setting: 4:3

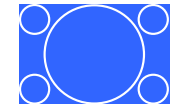
	Aspect Ratio of Input Signal		
	16:10	16:9	4:3
Auto or Normal			
4:3			

	Aspect Ratio of Input Signal		
	16:10	16:9	4:3
16:9			
Native*			

\* Only computer images and images from the HDMI input port/HDBaseT port. The image may differ depending on the resolution of the input signal.

Screen type setting: 16:9

	Aspect Ratio of Input Signal		
	16:10	16:9	4:3
Auto or Normal			
Full			
Zoom			
Native*			

\* The image may differ depending on the resolution of the input signal.

Screen type setting: 16:10

	Aspect Ratio of Input Signal		
	16:10	16:9	4:3
Auto or Normal			
16:9			
Full			
Zoom			
Native*			

\* The image may differ depending on the resolution of the input signal.

## Adjusting the Image

### Adjusting the Hue, Saturation, and Brightness

You can adjust the Hue, Saturation, and Brightness for R (red), G (green), B (blue), C (cyan), M (magenta), and Y (yellow) color components.

Make settings in the Configuration menu.

☛ **Image - Advanced - RGBCMY** p.117

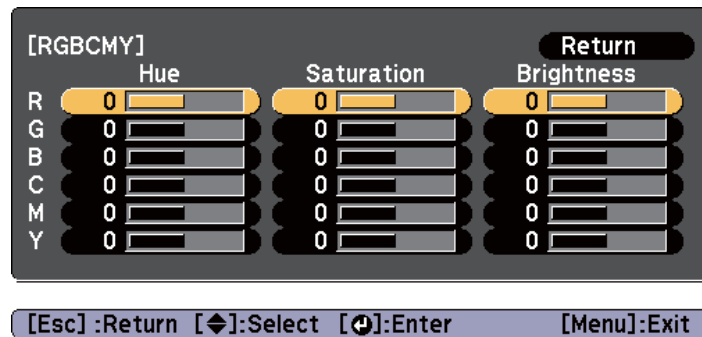

You can also make adjustments from **Multi-Projection** in the Configuration menu.

☛ **Extended - Multi-Projection - RGBCMY** p.122

### Gamma adjustment

Adjusts differences in the coloring for the projected image that occurs depending on the connected device.

Make settings in the Configuration menu.

☛ **Image - Advanced - Gamma** p.117

Select and adjust the correction value

☛ **Image - Advanced - Gamma** p.117

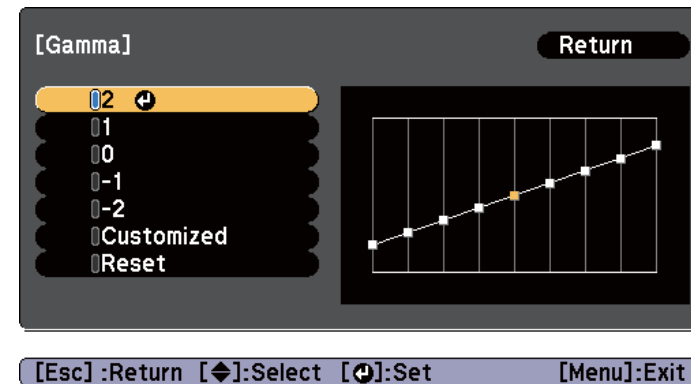

When a larger value is selected, the dark areas of images become brighter, but the color saturation for lighter areas may become weaker. When a smaller value is selected, you can reduce the overall brightness of the image to make the image sharper.

If you select **DICOM SIM** from **Color Mode** on the **Image** menu, select the adjustment value according to the projection size.

- If the projection size is 150 inches or less, select a small value.
- If the projection size is 150 inches or more, select a large value.



Medical images may not be reproduced correctly according to your settings and screen specifications.

Adjust while viewing the image

**Image - Advanced - Gamma - Customized - Adjust it from the image**  
[p.117](#)

Move the cursor on the projected image to the part where you want to change the brightness, and then press the [↵] button. Press the [▲][▼] buttons to adjust the value.

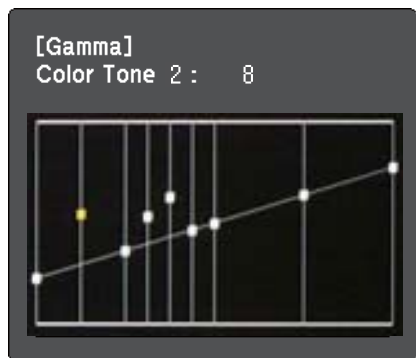
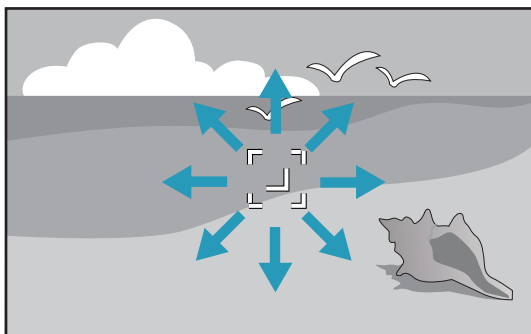

Adjust using the gamma adjustment graph

**Image - Advanced - Gamma - Customized - Adjust it from the graph**  
[p.117](#)

Adjust while looking at the gamma adjustment graph.

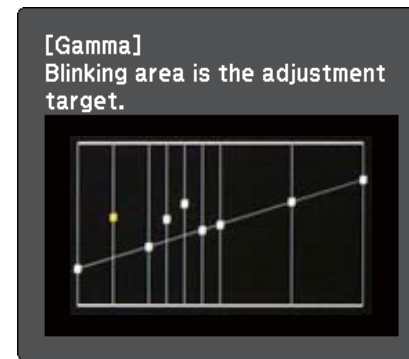

## Frame Interpolation (EB-Z10005U/EB-Z10000U/EB-Z9875U/EB-Z9870U/EB-Z9750U only)

The current and previous frames are used to create intermediate frames, interpolating to produce smooth-moving images. You can resolve clumsy-moving images, such as frame skipping when projecting a fast moving image.

Make settings in the Configuration menu.

☛ **Signal - Frame Interpolation** p.119

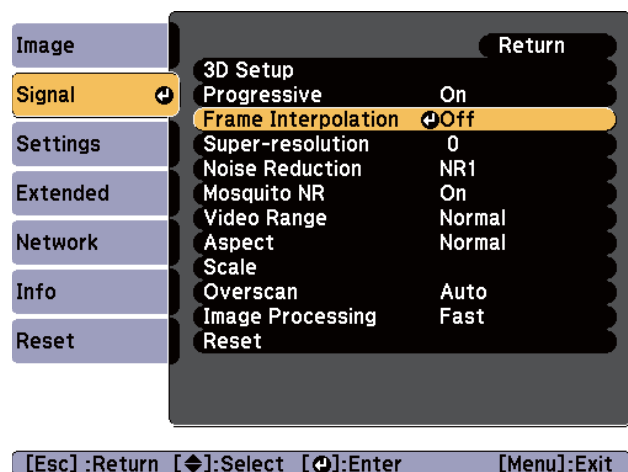

You can select the level of interpolation from **Low**, **Normal** or **High**. Set to **Off** if noise occurs when setting an interpolation level.

## Projecting 3D Images

By using two projectors, you can project passive 3D images. You need the following optional items to project and view 3D images. Make sure you read the notes in the user's guides supplied with the optional items.

- Polarizer (ELPPL01)  
This is only available for standard zoom lens ELPLS04, middle throw zoom lens ELPLM06, and long throw zoom lens ELPLL07.

- Passive 3D Glasses (ELPGS02A/ELPGS02B)

- Frame (ELPMB44)

☛ "Optional Accessories" p.198

When projecting 3D images, set **3D Images** to **On** in the Configuration menu.

☛ **Signal - 3D Setup - 3D Images** p.119

The following color modes are available when projecting 3D images. When projecting using the optional 3D polarizers (ELPPL01), you can view images at their optimal color tint.

- 3D Dynamic
- 3D Presentation
- 3D Theatre
- 3D Multi-Projection

☛ "Selecting the Projection Quality (Selecting Color Mode)" p.70



This projector arranges the polarizing direction of projection for R (red), G (green), and B (blue). It is not necessary to inverse left and right eye G (green) image signals.



## Useful Functions

This section describes the Multi-Projection, Split Screen, Memory, Schedule, and Security functions.

When projecting to a wide screen from multiple projectors, you can adjust the difference of brightness and color tone between each projected image to create a seamless screen.

There are two general methods of projecting from multiple projectors.

- Ⓐ Projecting different images from each projector, and creating a seamless screen

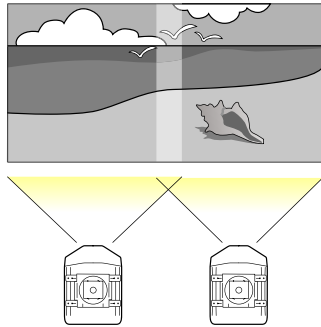

- Ⓑ Projecting the same image from each projector, using the Scale function to project a large image

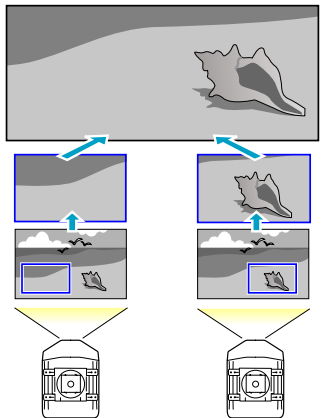

The basic setting method is the same, but you have to use the scale function to adjust the projection position for Ⓑ.

☛ "Combining Scaled Images" p.89

Here we will take Ⓐ as an example.



- We recommend setting the focus, zoom, and lens shift at least 20 minutes after you start the projection, because images are not stable right after turning on the projector.
- Set **Lamp Select** to **Dual**.
  - ☛ **Extended - Lamp Select** p.122
- If the values for **Geometric Correction** are large, the image position adjustment for overlapping images becomes difficult.
- The Test Pattern can be displayed to adjust the projection status without connecting video equipment.
  - ☛ "Displaying a Test Pattern" p.34
- If you project a dot by dot image that can be projected without being enlarged or reduced, you can make adjustments precisely.

## Preparation

Follow the steps below to adjust the projected images for the multi-projection function.

- 1 Set an ID for the projector and the remote control.
  - ☛ "Setting the projector ID" p.39



**2** Adjust the position of the projected image in the following order (starting from the adjustments that have larger corrections).

- (1) Projector's position (angle)
  - ☛ "Installation Settings" [p.30](#)
- (2) Lens shift/Zoom
  - ☛ "Adjusting the Position of the Projected Image (Lens shift)" [p.35](#)
  - ☛ "Adjusting the Zoom" [p.37](#)
- (3) Correct the four image corners
  - ☛ "Quick Corner" [p.62](#)
- (4) Correct the slight position misalignment that occurs when matching the projected images.
  - ☛ "Point Correction" [p.65](#)

**3** Set the **Color Mode** to **Multi-Projection** with the [Color Mode] button.



- You can also set from **Color Mode** in **Multi-Projection**.
  - ☛ **Extended - Multi-Projection - Color Mode** [p.122](#)
- When projecting 3D images, set it to **3D Multi-Projection**.

**4** Adjusts the color tone for the whole screen as necessary.

- ☛ "Color Uniformity" [p.183](#)

## Edge Blending

Follow the steps below to adjust the overlapping areas of the images.

- (1) Fine tune the overlapping areas to make seamless screen.
  - ☛ "Adjust the overlapping area of the images (Edge Blending)" [p.81](#)
- (2) Adjust the brightness difference for each projector lamp.
  - ☛ "Correcting the brightness" [p.83](#)
- (3) Adjust the color balance of the projected images.
  - ☛ "Fine-tuning the color balance" [p.85](#)

### Adjust the overlapping area of the images (Edge Blending)

You can fine tune the overlapping areas to make seamless screen.

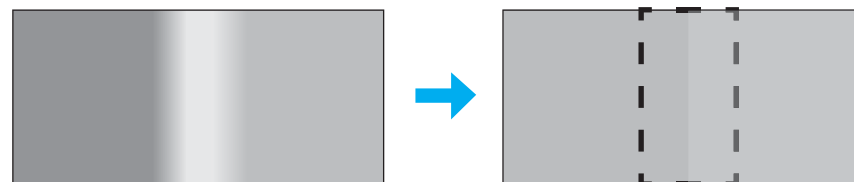

**1** Press the [Menu] button while projecting.

- ☛ "Using the Configuration Menu" [p.114](#)

**2** Select **Multi-Projection** from **Extended**.

- 3** Select **Edge Blending**, and then press the [**↵**] button.  
The following screen is displayed.

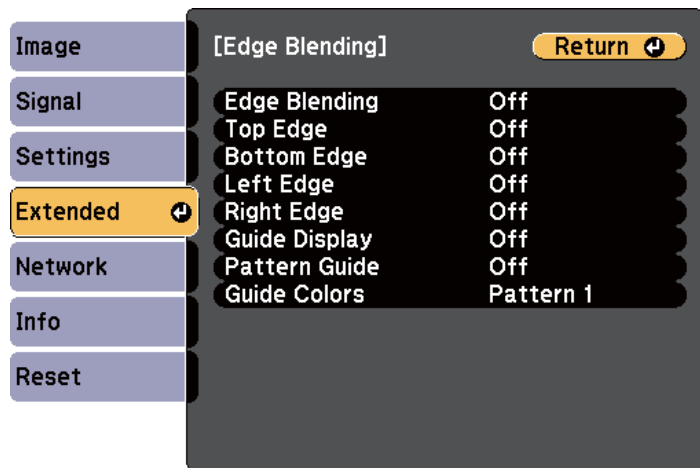

[Esc] / [**↵**]:Return [**↵**]:Select [Menu]:Exit

Submenu	Function
<b>Edge Blending</b>	Set to <b>On</b> to activate Edge Blending. Set to <b>Off</b> when not projecting from multiple projectors.
<b>Top Edge/Bottom Edge/Left Edge/Right Edge</b>	<b>Blending:</b> Set to <b>On</b> to activate Edge Blending towards your settings, and the blend range will be shaded. <b>Blend Range:</b> Adjusts the range to be shaded. Adjustment is possible at a level of one pixel. The maximum range is 45% of the resolution.
<b>Guide Display</b>	Set to <b>On</b> to display a guide on the Edge Blending setting range.
<b>Pattern Guide</b>	Set to <b>On</b> to display a guide to match the position of the Edge Blending setting range.
<b>Guide Colors</b>	Select a combination of guide colors from the three provided.

- 4** Turn on Edge Blending.
- (1) Select **Edge Blending**, and then press the [**↵**] button.
  - (2) Select **On**, and then press the [**↵**] button.
  - (3) Press the [Esc] button.
- 5** Set **Guide Display** to **On**.
- (1) Select **Guide Display**, and then press the [**↵**] button.
  - (2) Select **On**, and then press the [**↵**] button.
  - (3) Press the [Esc] button.



If the guide is not clear, you can change the color of the guide on **Guide Colors**.

- 6** Set **Pattern Guide** to **On**.
- (1) Select **Pattern Guide**, and then press the [**↵**] button.
  - (2) Select **On**, and then press the [**↵**] button.
  - (3) Press the [Esc] button.

**7** Set **Top Edge**, **Bottom Edge**, **Left Edge**, or **Right Edge** according to the parts of the image that are overlapped.

The following shows how to set screen (1) as an example.

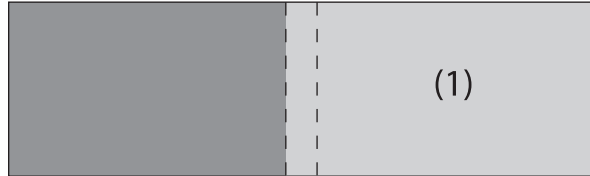

In the example above, you need to adjust the **Left Edge** because you can see the overlapping areas on the left side of the image (1).

- (1) Select **Left Edge**, and then press the [↵] button.
- (2) Select **Blending**, and then press the [↵] button.
- (3) Select **On**, and then press the [↵] button.
- (4) Press the [Esc] button.
- (5) In **Blend Range**, adjust the range to be shaded.

When a guide appears on the same position as the overlapping area, you can set the blend range with the selected value.

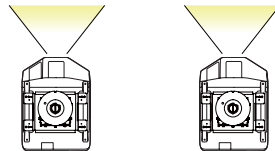
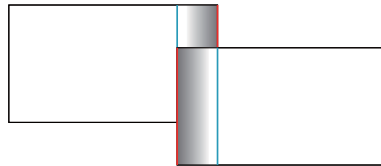

- (6) Press the [Esc] button.

**8** After the settings are complete, set **Guide Display** and **Pattern Guide** to **Off** to finish.

## Correcting the brightness

Adjust the **Brightness Level** so that the lamp brightness is the same for each projector.

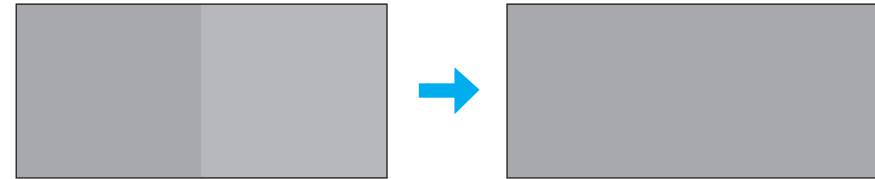

Adjust so that all projectors are the same brightness as the darkest lamp. You can adjust the brightness in five levels.



- Set **Power Consumption** to **Normal**.  
 ⚙ **Settings - Power Consumption p.121**
- You cannot adjust the **Brightness Level** during the portrait projection.
- Even if you adjust the **Brightness Level**, the brightness of each lamp may not match exactly.

- 1 Select **Brightness Level** from **Multi-Projection**, and then press the [↵] button.

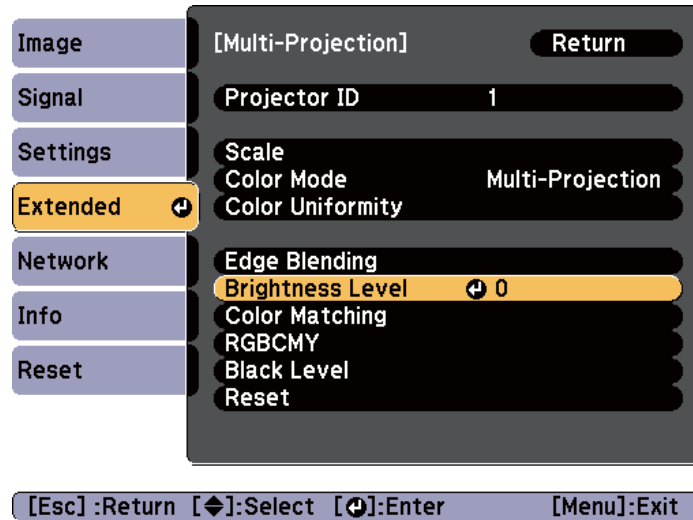

- 2 Select **1** to **5** as the brightness.

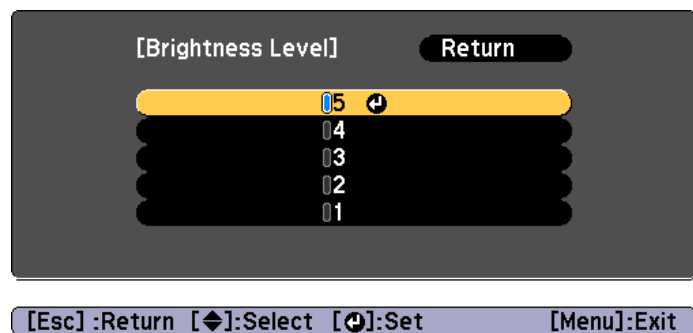

You can switch the projected image between the input image and the white image using the [◀][▶] buttons.

- 3 Press the [Esc] button to return to the previous screen.

## Fine-tuning the color balance

Adjust the brightness of the projected image and the color balance that was adjusted by Edge Blending.



The brightness and color may not be uniform even after making adjustments.

### Color Matching

You can fine tune the color balance and brightness from black to white for each color tone.

- 1 Select **Color Matching** from **Multi-Projection**, and then press the [**↵**] button.

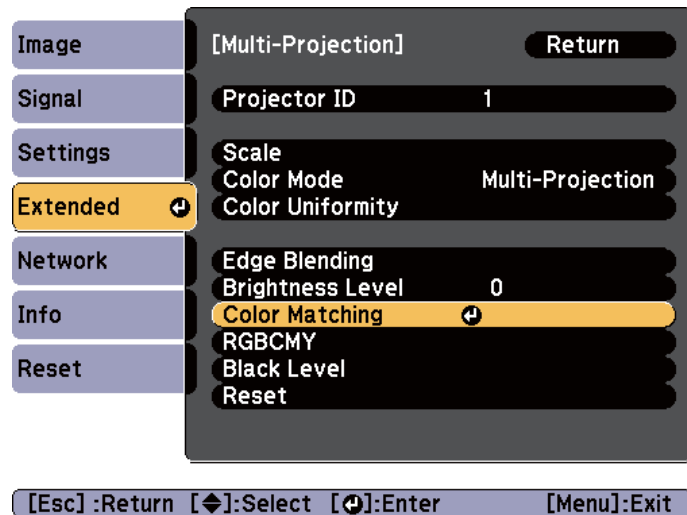

The following screen is displayed.

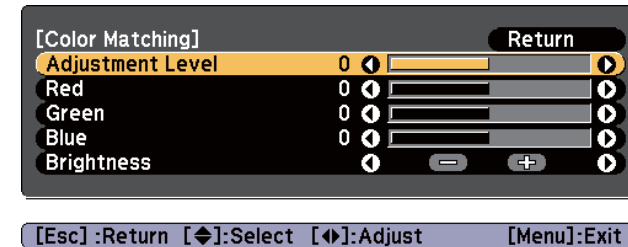

Half of the overlapped area is displayed in black so that it is easy to check the edge of the image.

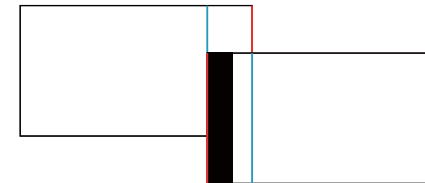

**Adjustment Level:** There are six levels from white through gray, and up to black. You can adjust each level individually.

**Red, Green, Blue:** Adjusts the tone for each color.

**Brightness:** Adjusts the image brightness.



Whenever the [**↵**] button is pressed, the screen changes between the projected image and the adjustment screen.

- 2 Select **Adjustment Level**, and then use the [**←**][**→**] buttons to set the adjustment level.
- 3 Select **Red**, **Green**, or **Blue**, and then press the [**←**][**→**] buttons to adjust the color tone.
- 4 Select **Brightness**, and then use the [**←**][**→**] buttons to adjust the brightness.

- 5 Return to step 2 and adjust each level.
- 6 Press the [Esc] button to return to the previous screen.

## Adjusting RGBCMY

You can adjust the Hue, Saturation, and Brightness for R (red), G (green), B (blue), C (cyan), M (magenta), and Y (yellow) color components.

☛ "Adjusting the Hue, Saturation, and Brightness" [p.76](#)

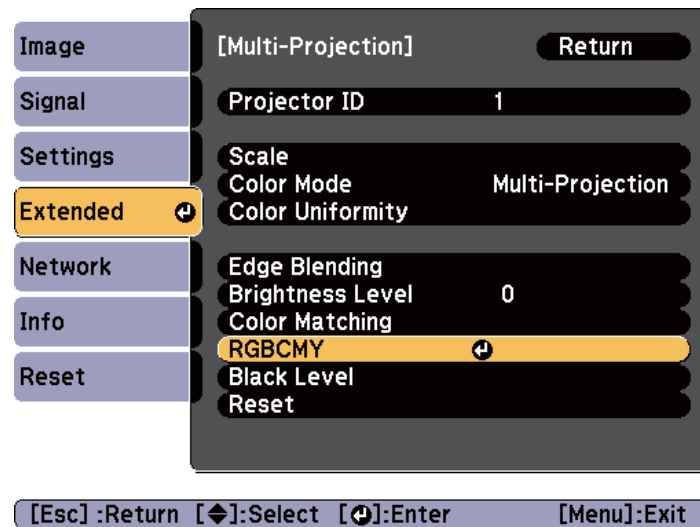

## Black Level

When a black image is displayed, only areas where the images overlap stands out. The black level function allows you to match the brightness and tone for areas where the images do not overlap with areas where the images overlap, to make the difference less noticeable.

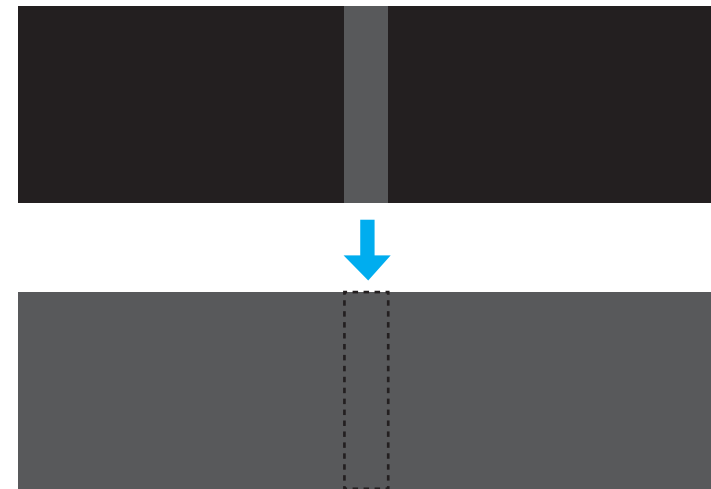

- **Black Level** can only be adjusted correctly in images where two images overlap.
- You cannot adjust the black level when a test pattern is displayed.
- If the **Geometric Correction** value is large, you may not be able to adjust correctly.
- The brightness and tone may differ in areas where the images overlap as well as in other areas even after performing black level adjustment.
- If you change the **Top Edge/Bottom Edge/Right Edge/Left Edge** setting, the Black Level is returned to its default value.
  - ☛ "Adjust the overlapping area of the images (Edge Blending)" [p.81](#)

- 1** Select **Black Level** from **Multi-Projection**, and then press the [↵] button.

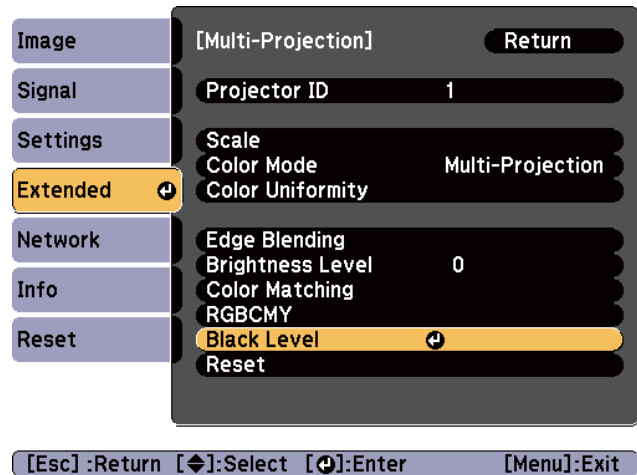

- 2** Select **Color Adjustment**, and then press the [↵] button.

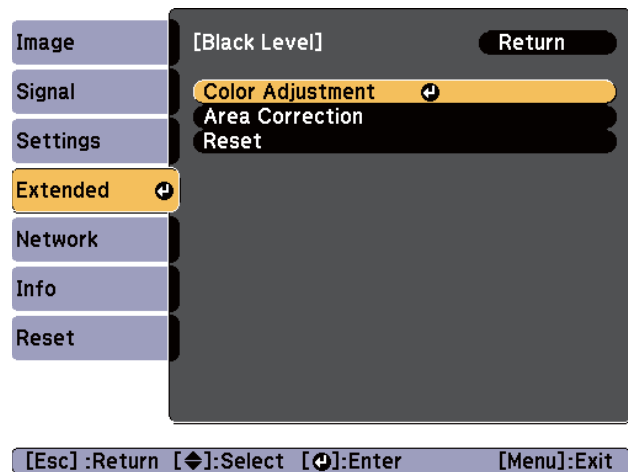

- 3** Adjust the black tone and brightness for the areas that do not overlap to match the areas that overlap.

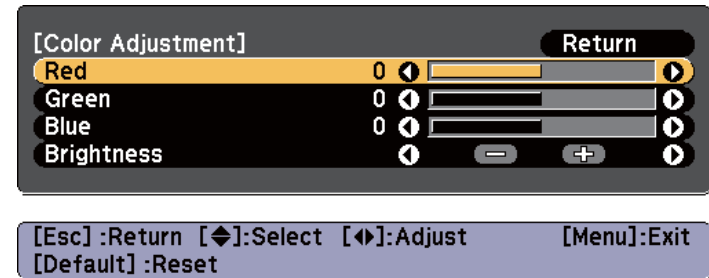

After this, if the tone for some areas do not match, adjust them by **Area Correction**.

- 4** Press the [Esc] button, to return to the screen displayed in step 2.

- 5** Select **Area Correction**, and then press the [**↵**] button.

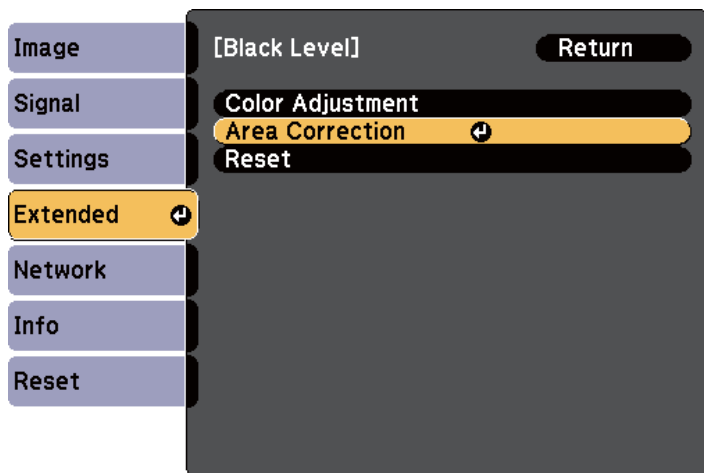

[Esc]:Return [◆]:Select [⏎]:Enter [Menu]:Exit

The points where you want to set the range for adjustment are displayed.

The points are displayed based on the settings for **Top Edge/Bottom Edge/Right Edge/Left Edge**.

The number of points displayed on one side differs depending on the adjustment method selected in geometric correction.

Example: When **Left Edge** is **On** and **Point Correction** (5x5) is selected

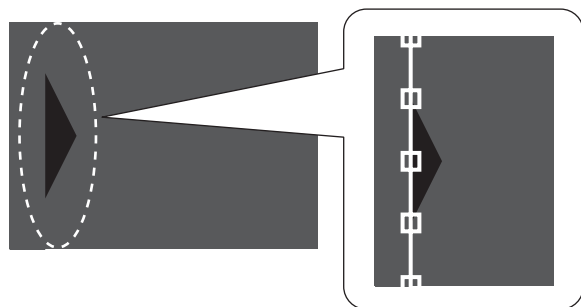

- 6** Press the [**▲**][**▼**][**◀**][**▶**] buttons to select the point you want to move, and then press the [**↵**] button.

The selected point is displayed in orange.

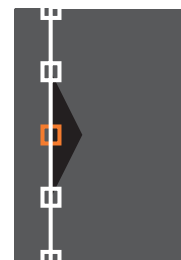

- 7** Press the [**▲**][**▼**][**◀**][**▶**] buttons to move the point.

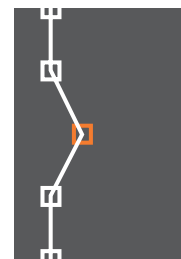

To continue to move another point, press the [Esc] button to return to step 6, and then repeat steps 6 and 7.



To return **Black Level** to its default value, press the [Esc] button to return to the screen from step 5, select [Reset], and then press the [**↵**] button.

- 8** To complete the adjustment, press the [Menu] button.



## Combining Scaled Images

A section of the image is cropped and displayed. This allows you to create one large image by combining images projected from multiple projectors.

- 1 Project the image, and then press the [Menu] button.

☛ "Using the Configuration Menu" p.114

- 2 Select **Multi-Projection** from **Extended**.



You can also perform the same operation from **Scale** in **Signal**.

- 3 Select **Scale**, and then press the [↵] button.

- 4 Set **Scale** to **On**.

- (1) Select **Scale**, and then press the [↵] button.
- (2) Select **On**, and then press the [↵] button.
- (3) Press the [Esc] button to return to the previous screen.

- 5 Set **Scale Mode**.

- (1) Select **Scale Mode**, and then press the [↵] button.

- (2) Select **Zoom Display** or **Full Display**, and then press the [↵] button.

**Zoom Display:** Adjusts according to the image currently displayed.

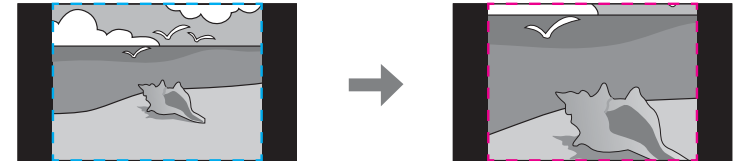

- (2) **Full Display:** Adjusts according to the projector's panel size (the maximum area in which an image can be displayed).



- (3) Press the [Esc] button to return to the previous screen.

### 6 Adjust the scale.

Select the adjustment method with the [▲][▼] buttons, then adjust using the [◀][▶] buttons.

- +: Enlarges or reduces an image vertically and horizontally at the same time.

Scale Vertically: Enlarges or reduces an image vertically.

Scale Horizontally: Enlarges or reduces an image horizontally.

### 7 Adjust the **Image Display Range**.

(1) Select **Image Display Range**, and then press the [↵] button.

(2) Press the [▲][▼][◀][▶] buttons to scroll the image.

Adjust the coordinates and size of each image while viewing the screen.

(3) Press the [Menu] button to finish making settings.

## Projecting Two Images Simultaneously (Split Screen)

You can simultaneously project images from two sources on the right and left of the screen.

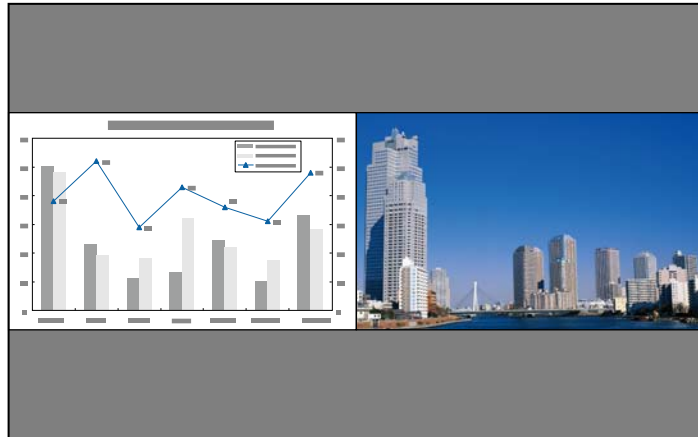

- The following input source combinations cannot be projected using the split screen function.
  - Computer and BNC
  - S-Video and Video
  - HDMI and HDBaseT
  - DVI-D and HDMI
  - DVI-D and HDBaseT
- You cannot project the same input source on both sides (left and right) of the screen.

## Operating procedures

Projecting on a split screen

- Press the [Split] button on the remote control while projecting. The currently selected input source is projected on the left of the screen.

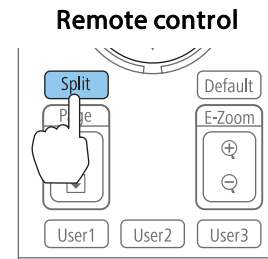

You can also perform the same operations in the Configuration menu.

 **Settings - Split Screen** [p.121](#)

- Press the [Menu] button. The Split Screen Setup screen is displayed.

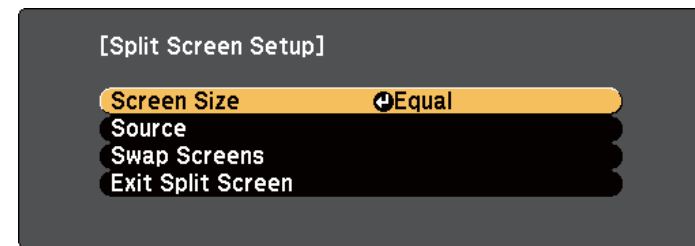

[↔]:Select [↵]:Enter [Menu]:Exit

- Select **Source**, and then press the [↵] button.

**4** Select each input source for **Left** and **Right**.

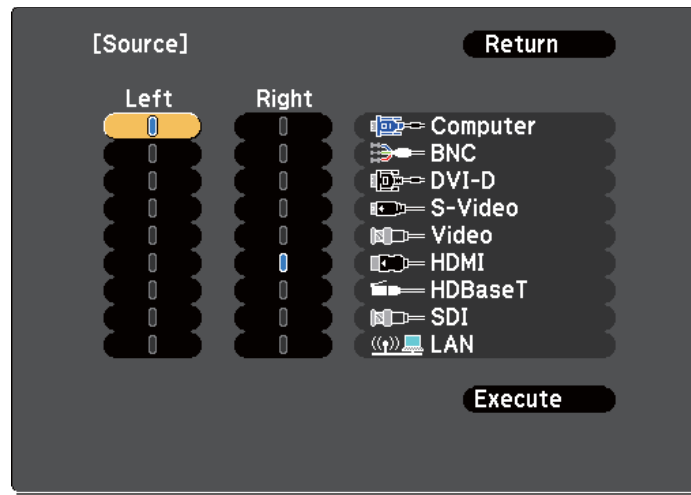

[Esc]:Return [Left/Right]:Select [Enter]:Set [Menu]:Exit



You can perform the same operations using the following procedure.

- ☛ "Automatically Detect Input Signals and Change the Projected Image (Search)" [p.58](#)
- ☛ "Switching to the Target Image" [p.59](#)

**5** Select **Execute**, and then press the [↵] button.

To switch the source during split screen projection, start the procedure from step 2.

### Switching the left and right screens

Use the following procedure to switch the projected images displayed on the left and right screens.

- 1** Press the [Menu] button during split screen projection.
- 2** Select **Swap Screens**, and then press the [↵] button.  
The projected images on the left and right are swapped.

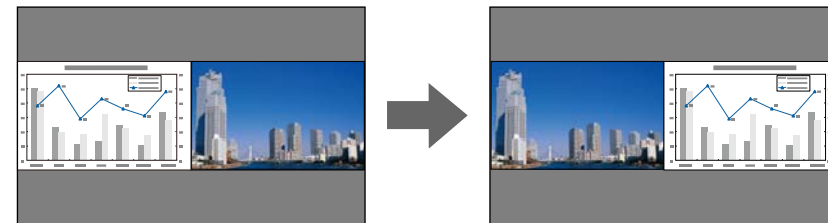

### Switching the left and right image sizes

- 1** Press the [Menu] button during split screen projection.
- 2** Select **Screen Size**, and then press the [↵] button.
- 3** Select the screen size you want to display, and then press the [↵] button.

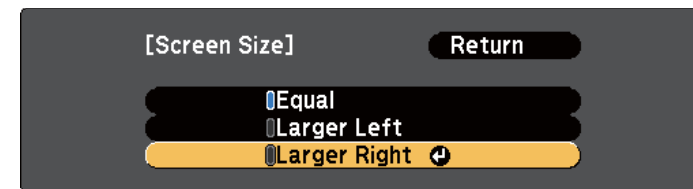

[Esc]:Return [Up/Down]:Select [Enter]:Set [Menu]:Exit

The projected images appear as shown below after setting the screen size.

**Equal**

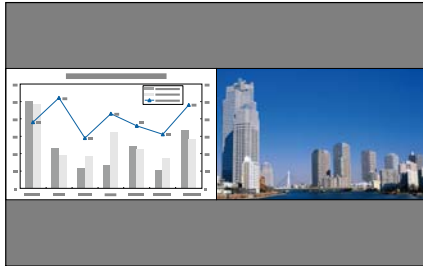

**Larger Left**

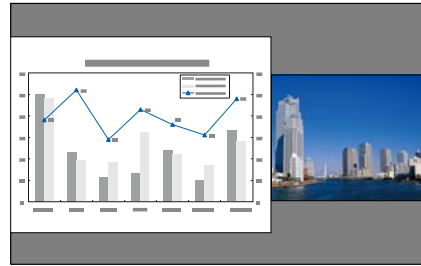

**Larger Right**

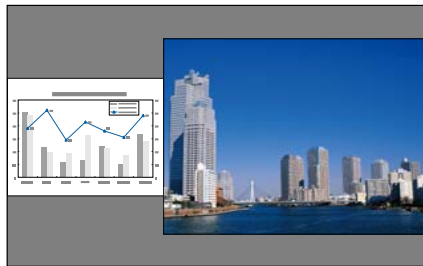

- You cannot enlarge both the left screen and right screen images at the same time.
- When one image is enlarged, the other image is reduced.
- Depending on the image signals that are being input, the images on the left and right may not appear to be the same size even if **Equal** is set.

Ending split screen

**Press the [Esc] button to end split screen.**

The following steps can also be used to end split screen.

- Press the [Split] button on the remote control.

- Select **Exit Split Screen** on the Split Screen Setup screen.  [p.91](#)

## Restrictions during split screen projection

Operating restrictions

The following operations cannot be performed during split screen projection.

- Setting the Configuration menu
- E-Zoom
- Changing the aspect mode
- Using the [User1], [User2], or [User3] button on the remote control
- Help can be displayed only when image signals are not being input or when an error or warning notification is displayed.
- The user's logo is not displayed.

Restrictions relating to images

- The default values for the **Image** menu are applied to the image on the right screen. However, the settings for the image projected on the left screen are applied to the image on the right screen for **Color Mode**, **Color Temp.**, and **Advanced**.
- The **Frame Interpolation** and **Super-resolution** settings in the **Signal** menu are applied to the image projected on the left screen.
- **Auto Iris** is not available.
  -  **Image - Auto Iris** [p.117](#)

## Hiding the Image Temporarily (Shutter)

You can switch off the image on the screen when you want to focus the audience's attention on what you are saying, or when you do not want to display operations such as changing files.

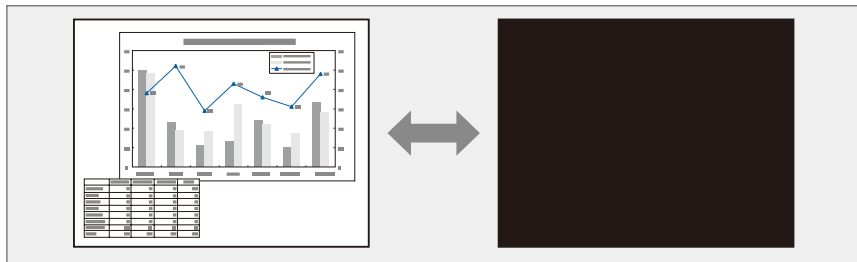

Each time you press the [Shutter] button, the shutter function turns on or off.

### Remote control

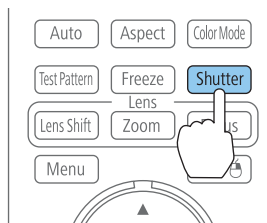

- When the shutter function is activated and no operations are performed for about 120 minutes, the projector turns off automatically. If you do not want to turn off the power, set **Shutter Timer** to **Off**.

☛ **Extended - Operation - Shutter Timer** p.122

- If you press the [⏏] button while the shutter is closed, the shutter is automatically released and a message requesting confirmation to turn off the power is displayed on the screen.
- The Lamp1 and Lamp2 indicators flash while the shutter function is activated.
- When an event that is set in the schedule function is executed, the shutter function is released.
- When **Shutter Release** is set to **Shutter** in the Extended menu, the following operations can be performed while the shutter function is still being activated.
  - Change the source with the change input buttons on the remote control.
  - Control the projector from a computer using communication commands.

☛ **Extended - Operation - Advanced - Shutter Release** p.122

The shutter function is only released by pressing the [Shutter] button, or by sending a command to release the shutter function.

- When projecting moving images, the images continue to be played back while the shutter function is activated. It is not possible to resume projection from the point where the shutter function was activated.
- The lamp is still lit while the shutter function is activated, so the lamp hours continue to accumulate.

## Freezing the Image (Freeze)

When Freeze is activated on moving images, the frozen image continues to project on the screen, so you can project a moving image one frame at a time like a still photo. Also, you can perform operations such as changing between files during presentations from a computer without projecting any images if the Freeze function is activated beforehand.

Each time you press the [Freeze] button, the Freeze function turns on or off.

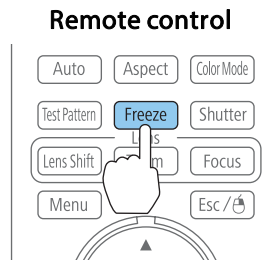

- When projecting moving images, the images continue to be played back while the screen is frozen. It is not possible to resume projection from the point where the screen was frozen.
- If the [Freeze] button is pressed while the Configuration menu or the Help screen is displayed, the menu or the Help screen that is displayed is closed.
- Freeze still works while E-Zoom is being used.

## Enlarging Part of the Image (E-Zoom)

This is useful when you want to expand images to see them in greater detail, such as graphs and tables.

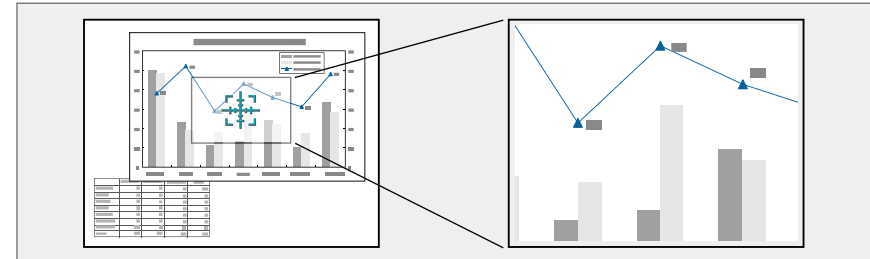

**1**

Start E-Zoom.

Press the [⊕] button to display the target scope (⊕).

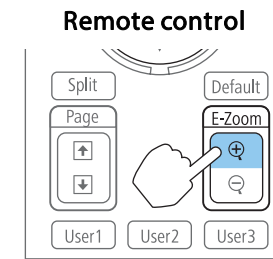

- 2 Move the target scope (  ) to the area of the image that you want to enlarge.

### Remote control

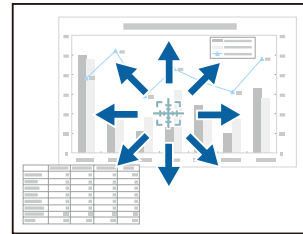
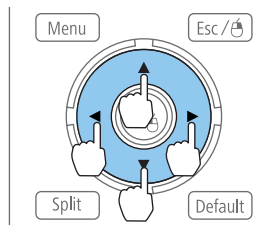

- 3 Enlarge.

### Remote control

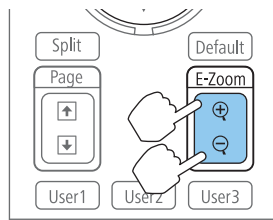

[⊕] button: Expands the area each time it is pressed. You can expand quickly by holding the button down.

[⊖] button: Reduces images that have been enlarged.

[Esc] button: Cancels E-Zoom.

- During enlarged projection, press the [▲][▼][◀][▶] buttons to scroll the image.
- E-Zoom is unavailable when **Scale** is set to **On**.  
 **Signal - Scale** [p.119](#)

## Saving a User's Logo

You can save the image that is currently being projected as a User's Logo.

 Once a User's Logo has been saved, the logo cannot be returned to the factory default.

- 1 Project the image you want to save as the User's Logo, and then press the [Menu] button.

 "Using the Configuration Menu" [p.114](#)

- 2 Select **User's Logo** from **Extended**.

- When **User's Logo Protection** from **Password Protection** is set to **On**, a message is displayed and the User's Logo cannot be changed. You can make changes after setting **User's Logo Protection** to **Off**.  
 "Managing Users (Password Protection)" [p.107](#)
- If **User's Logo** is selected when Geometric Correction, E-Zoom or Aspect are being performed, the function currently being performed is temporarily canceled.

- 3 When the message "Choose this image as the User's Logo?" is displayed, select **Yes**.

 When you press the [↵] button, the screen size may change depending on the signal to match the actual resolution of the image signal.



- 4** Move the box to select the part of the image to use as the User's Logo.

You can perform the same operations from the projector's control panel.

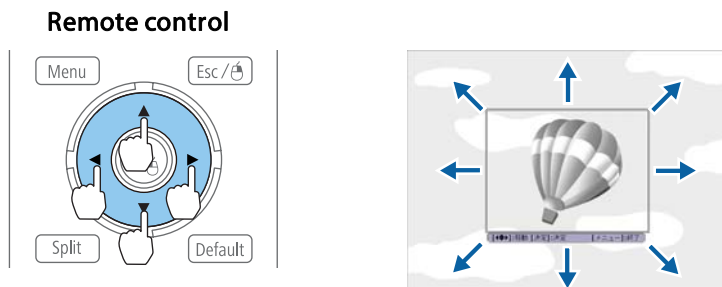

You can save at 400x300 dots in size.

- 5** When you press the [↵] button and the message "Select this image?" is displayed, select **Yes**.

- 6** Select the zoom factor from the zoom setting screen.

- 7** When the message "Save this image as the User's Logo?" is displayed, select **Yes**.

The image is saved. After the image has been saved, the message "Completed." is displayed.



When a User's Logo is saved, the previous User's Logo is erased.

The settings for the image currently displayed are saved as a memory, allowing you to load them when necessary. Settings for the following menu items are saved in the memory.

Top Menu	Submenu
Image	All setting items
Signal	Progressive Frame Interpolation Noise Reduction Mosquito NR Video Range Scale Overscan Image Processing 3D Images Super-resolution
Settings	Power Consumption
Extended	Multi-Projection - Brightness Level - Edge Blending - Color Matching - Black Level

## Saving/Loading/Erasing the Memory

- 1 Press the [Menu] button while an image is being displayed.  
 ➔ "Using the Configuration Menu" [p.114](#)
- 2 Select **Memory** from **Settings**, and then press the [**↵**] button.

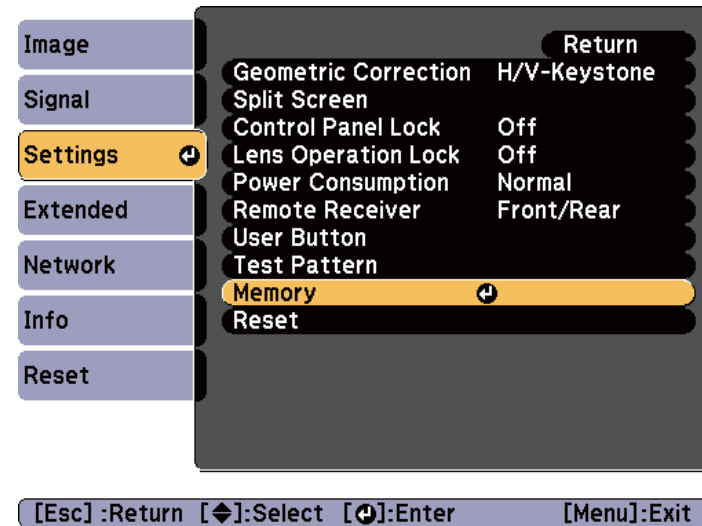

**3** Select the function you want to perform, then press the [↵] button.

You can only perform **Load Memory** and **Save Memory** when an image is displayed.

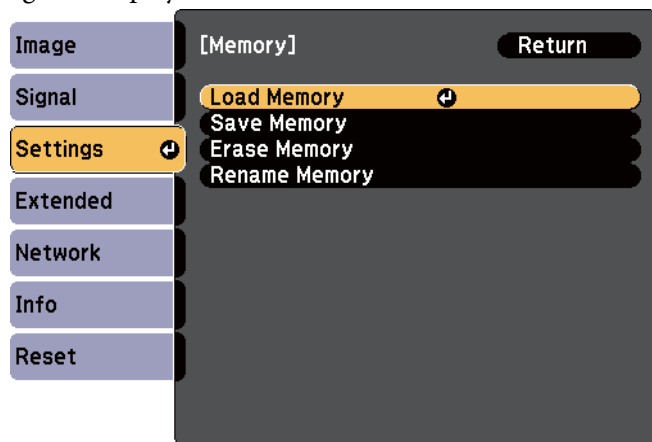

[Esc]:Return [↕]:Select [↵]:Enter [Menu]:Exit

Function	Explanation
<b>Load Memory</b>	Loads the saved memory. When you select a memory and press the [↵] button, the settings applied to the current image are replaced with the settings from the memory.
<b>Save Memory</b>	The settings for the image currently displayed are saved as a memory. When you select a memory name and press the [↵] button, the settings are saved.
<b>Erase Memory</b>	Erases the registered memory. When you select a memory name and press the [↵] button, a message is displayed. Select <b>Yes</b> , and then press the [↵] button to erase the selected memory. You can erase all memories from <b>Reset Memory</b> . ☛ <b>Reset - Reset Memory</b> p.138

Function	Explanation
<b>Rename Memory</b>	Changes the memory name. Select the memory name you want to change, and then press the [↵] button. Enter the memory name using the soft keyboard. ☛ "Soft keyboard operations" p.128 When you have finished, move the cursor over <b>Finish</b> , and then press the [↵] button.

When a memory has already been saved, the memory name and its color mode are displayed.

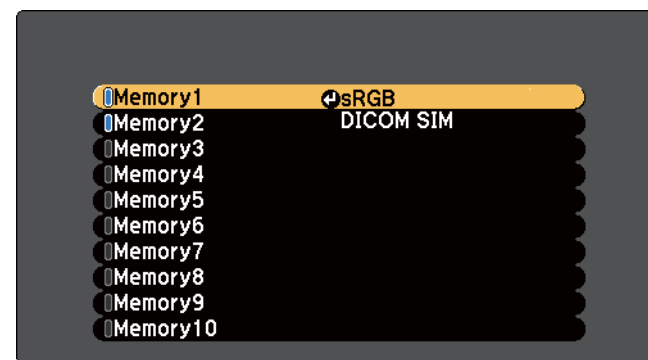

- You can register up to ten types of memory.
- If the mark on the left of the memory name is turned blue, it means the memory has already been registered. When you select a registered memory, a message is displayed asking you to confirm if you want to overwrite the memory. If you select **Yes**, the previous settings are deleted and the current settings are registered.

You can schedule turning the projector power on/off and switching the input source, as events in the schedule. Registered events are executed automatically at the specified time on the specified dates or weekly. You can register up to 30 events.

## Setting the Time

You can set the time for the projector. The set time is used for the schedule function.

☛ "Saving a Schedule" [p.101](#)



- When you turn on the projector for the first time, the message "Do you want to set the time?" is displayed. When you select **Yes**, the screen from step 4 is displayed.
- When **Time/Schedule Protection** is set to **On** in **Password Protection**, settings related to the date and time cannot be changed. You can make changes after setting **Time/Schedule Protection** to **Off**.

☛ "Managing Users (Password Protection)" [p.107](#)

**1** Press the [Menu] button while projecting.

☛ "Using the Configuration Menu" [p.114](#)

**2** Select **Operation** from **Extended**.

**3** Select **Date & Time**, and then press the [↵] button.

**4** Make settings for the date and time.

Use the soft keyboard to enter the date and time.

☛ "Soft keyboard operations" [p.128](#)

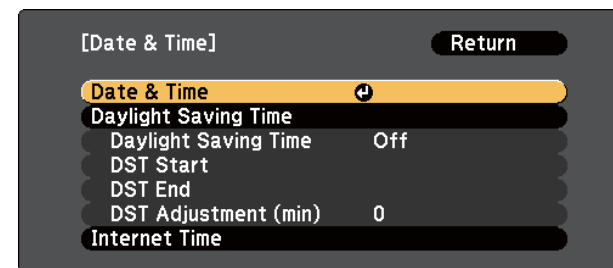

Submenu		Function
Date & Time	Date	Set today's date.
	Time	Set the current time.
	Time Difference (UTC)	Set the time difference from Coordinated Universal Time.
	Set	Applies the <b>Date &amp; Time</b> settings.
Daylight Saving Time	Daylight Saving Time	Set whether or not to activate the daylight saving time. <b>DST Adjustment (min)</b> adjusts the time difference between the standard time and daylight saving time.
	DST Start	Set the date and time to start the daylight saving time.*
	DST End	Set the date and time to end the daylight saving time.*
	Set	Applies the <b>Daylight Saving Time</b> settings.
Internet Time	Internet Time	Set to <b>On</b> to update the time automatically through an Internet time server.
	Internet Time Server	Enter the IP address for an Internet time server.
	Set	Applies the <b>Internet Time</b> settings.

\* When setting it for the last Sunday of the month, set the **Week** to 5.



When changing settings, make sure you select **Set**, and then press the [↵] button.

**5** Press the [Menu] button to finish making settings.

## Saving a Schedule

### Setting a schedule

- 1** Press the [Menu] button while projecting.  
 "Using the Configuration Menu" p.114
- 2** Select **Schedule Settings** from **Extended**.
- 3** Select **Add New** from **Schedule**.

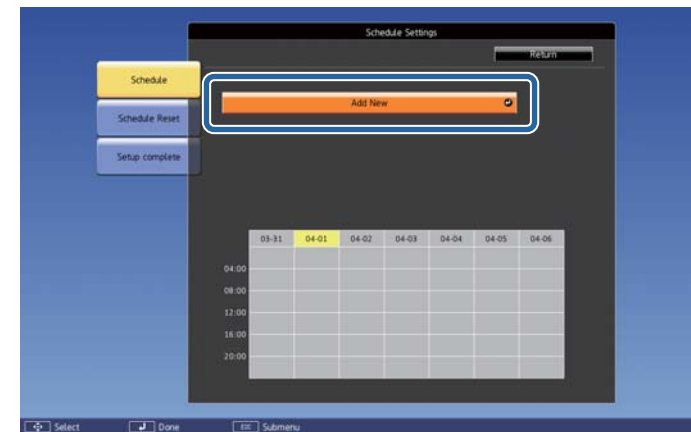

**4** Set the event.

Submenu Name	Function
<b>Event Settings</b>	Select an operation of the projector when the event is executed. Select <b>No Change</b> for items that you do not want to change when the event occurs. You can set the following item operations. <ul style="list-style-type: none"> <li>• Power</li> <li>• Source</li> <li>• Power Consumption (disabled during portrait projection)</li> <li>• Shutter</li> <li>• Lamp Relay Mode</li> </ul>
<b>Date / Time Settings</b>	Set the date, day of the week, and time to execute the event. Use the soft keyboard to enter the date and time. 🖱️ "Soft keyboard operations" p.128

**5** Select **Save**, and then press the [↵] button.  
 To register additional events, repeat steps 3 to 5.

**6** Select **Setup complete**, and then select **Yes** to finish saving.

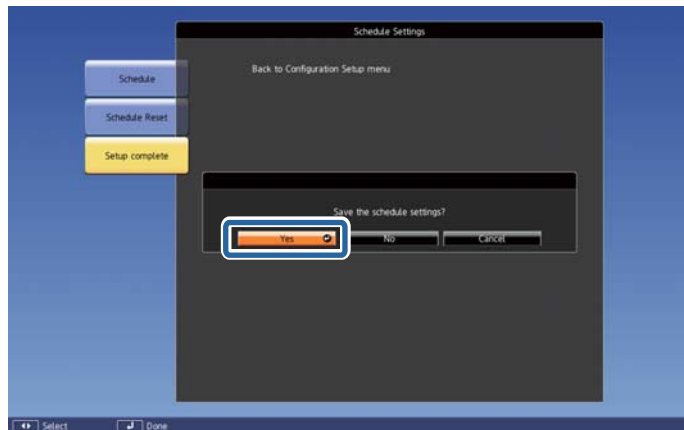

## Lamp Relay Mode

Specify the date and time to automatically switch to the lamp you want to turn on.

By switching the lamps, you can reduce the the load on the lamps and prevent deterioration.

Lamp Relay Mode is only available when **Lamp Select** is set to **Dual** or **Single**.

🖱️ "Selecting the lamp" p.31

When it is set to **Dual**:

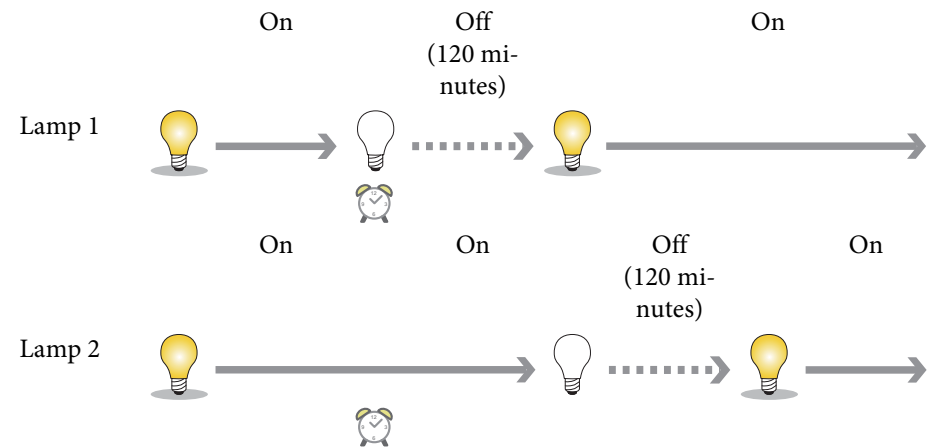

 : Specified time

When it is set to **Single**:

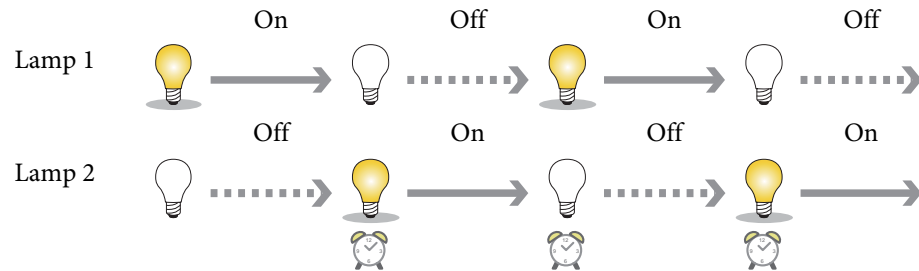



 : Specified time





- When you set a total of two or more Lamp Relay Mode events, you can enable only one of the events.
- When another event is registered with a date specified at the same time in Lamp Relay Mode, the other event is executed.

**1** Select **Add New** from **Schedule**.

 "Setting a schedule" [p.101](#)

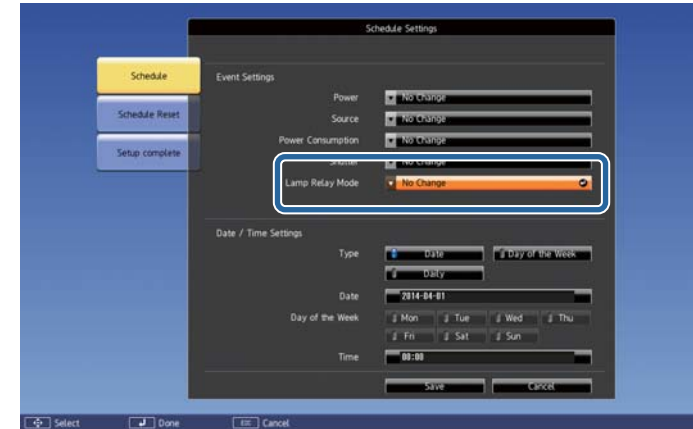
**2** Select **Lamp Relay Mode**, and then press the [] button.



**3** Select **On**, and then press the [] button.

**4** Select the period for Lamp Relay Mode from **Type**.

Day of the Week: Lamp Relay Mode is executed at the specified time on the same day of the week.

Daily: Lamp Relay Mode is executed at the specified time every day.

**5** Set the **Day of the Week** and **Time** based on the **Type** settings. Use the soft keyboard to enter the date and time.

 "Soft keyboard operations" [p.128](#)

**6** Select **Save**, and then press the [] button.

- 7** Select **Setup complete**, and then select **Yes** to finish saving.

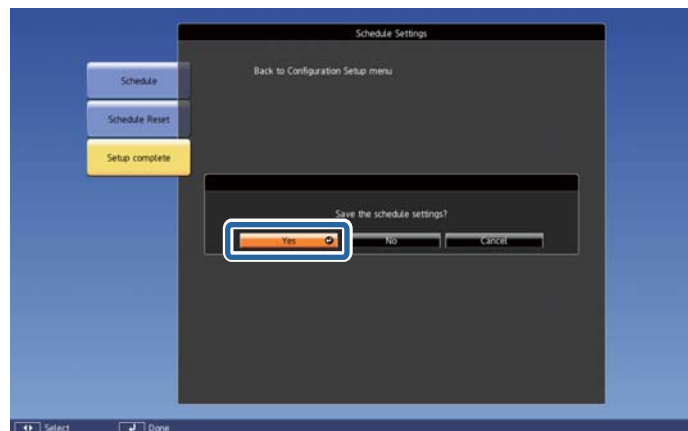

## Checking a schedule

- 1** Press the [Menu] button while projecting.
- 2** Select **Schedule Settings** from **Extended**.  
The indicator appears at the time when an event is saved.



- (Aqua): Single event
- (Orange): Regular event
- (Green): Communication monitoring On/Off
- (Gray): Disabled event



- Press the [◀][▶] buttons to highlight the date you want to check.  
The details of the events registered on the selected date are displayed.



- (Blue): Enabled event
- (Gray): Disabled event
- : Regular event

## Editing a schedule

- Press the [Menu] button while projecting.  
☛ "Using the Configuration Menu" p.114
- Select **Schedule Settings** from **Extended**.
- Press the [◀][▶] buttons to highlight the date containing the event you want to edit.



- 4** Highlight the event you want to edit, and then press the [Esc] button.

The menu is displayed.

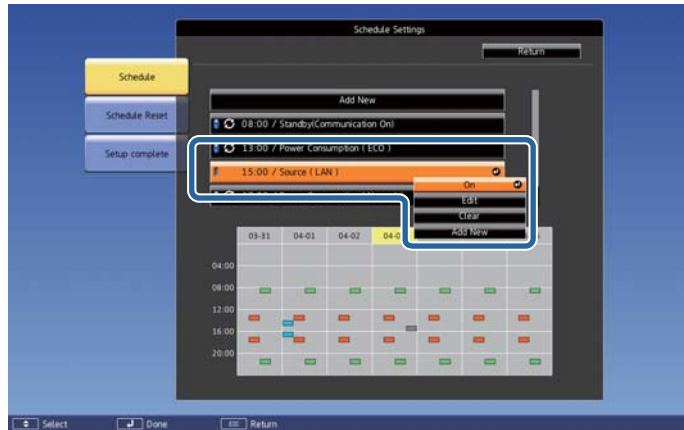

- 5** Edit the event.

Submenu Name	Function
<b>On/Off</b>	Enables or disables the selected event. (You can enable only one Lamp Relay Mode event.)
<b>Edit</b>	Change the event details or date and time. Select <b>Save</b> , and then press the [↵] button to complete the editing.
<b>Clear</b>	Deletes the selected event.
<b>Register</b>	Saves a new event. Select <b>Save</b> , and then press the [↵] button to complete the registration.

- 6** Select **Setup complete**, and then select **Yes** to finish editing.

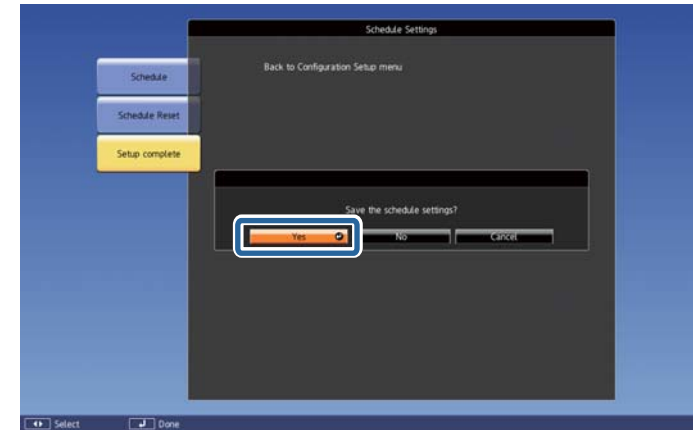

To delete all registered schedules, select **Schedule Reset**, and then select **Yes**. Select **Setup complete**, and then select **Yes**.

The projector has the following security functions.

- **Password Protection**  
You can limit who can use the projector.
- **Control Panel Lock/Lens Operation Lock/Remote Control Button Lock**  
You can prevent people changing the settings on the projector without permission.  
☛ "Restricting Operation" [p.110](#)
- **Anti-Theft Lock**  
The projector is equipped with an anti-theft security device.  
☛ "Anti-Theft Lock" [p.112](#)

---

## Managing Users (Password Protection)

When Password Protection is activated, people who do not know the password cannot use the projector to project images even if the projector power is on. Furthermore, the user's logo that is displayed when you turn on the projector cannot be changed. This acts as an anti-theft function as the projector cannot be used even if it is stolen. At the time of purchase, Password Protection is not activated.

### Kinds of Password Protection

The following three kinds of Password Protection settings can be made according to how the projector is being used.

#### 1. Power On Protection

When **Power On Protection** is **On**, you need to enter a preset password after the projector is plugged in and turned on (this also applies to Direct Power On). If the correct password is not entered, projection does not start.

#### 2. User's Logo Protection

When **User's Logo Protection** is set to **On**, the following setting changes for the User's Logo are prohibited.

- Capturing a User's Logo
- Changing the settings for **Display Background** and **Startup Screen** from **Display** in the Extended menu

#### 3. Network Protection

When **Network Protection** is set to **On**, changing the settings for the **Network** menu is prohibited.

#### 4. Time/Schedule Protection

When **Time/Schedule Protection** is set to **On**, changing settings for the projector's system time or schedules is prohibited.

## Setting Password Protection

- 1 During projection, hold down the [Freeze] button for about five seconds.

The Password Protection setting menu is displayed.

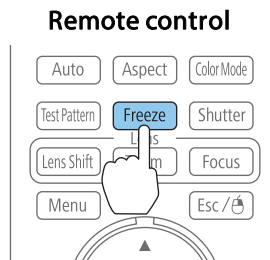

If Password Protection is already activated, you must enter the password.  
If the password is entered correctly, the Password Protection setting menu is displayed.

☞ "Entering the Password" [p.109](#)

- 2 Select the type of Password Protection you want to set, and then press the [↵] button.

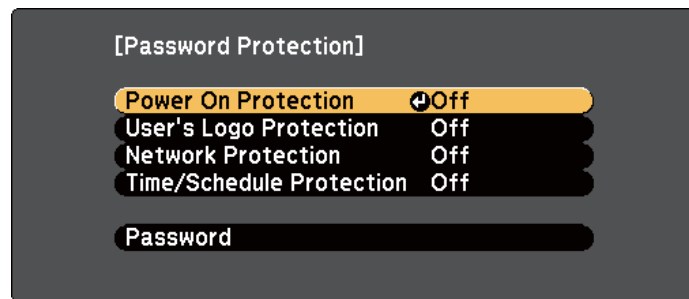

[↵]:Select [↵]:Enter

[Menu]:Exit

- 3 Select **On**, and then press the [↵] button.  
Press the [Esc] button to return to the screen in step 2.

- 4 Set the password.
  - (1) Select **Password**, and then press the [↵] button.
  - (2) When the message "Change the password?" is displayed, select **Yes** and then press the [↵] button. The default password is set to "0000". Change this to your own desired password. If you select **No**, the screen displayed in step 2 is displayed again.
  - (3) While holding down the [Num] button, enter a four digit number using the numeric buttons. The number entered is displayed as "\* \* \* \*". When you enter the fourth digit, the confirmation screen is displayed.

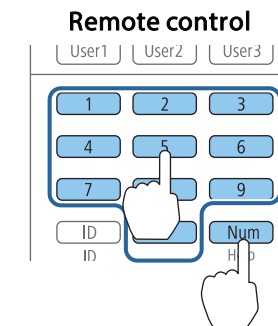

- 4) Re-enter the password.  
The message "Password accepted." is displayed.  
If you enter the password incorrectly, a message is displayed prompting you to re-enter the password.

## Entering the Password

When the password entry screen is displayed, enter the password using the remote control.

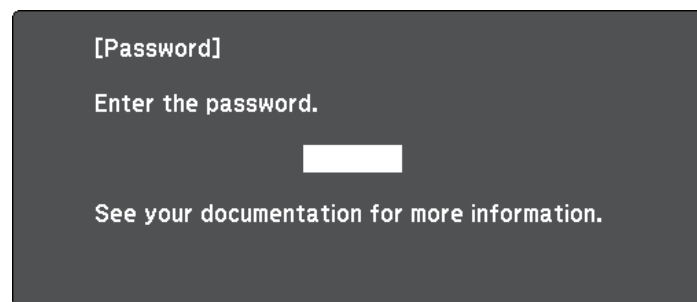

While holding down the [Num] button, enter the password by pressing the numeric buttons.



[0-9] :Enter

When you enter the correct password, Password Protection is temporarily released.

### Attention

- If an incorrect password is entered three times in succession, the message "The projector's operation will be locked." is displayed for approximately five minutes, and then the projector switches to standby mode. If this happens, disconnect the power plug from the electrical outlet and then reinsert it and turn the projector's power back on. The projector displays the password entry screen again so that you can enter the correct password.
- If you have forgotten the password, make a note of the "Request Code: xxxxx" number that appears on the screen and contact the nearest address provided in the Epson Projector Contact List.  
 [Epson Projector Contact List](#)
- If you continue to repeat the above operation and input the wrong password 30 times in succession, the following message is displayed and the projector does not accept any more password entries.  
"The projector's operation will be locked. Contact your nearest Epson service center."  
 [Epson Projector Contact List](#)

## Restricting Operation

The following three kinds of operation restriction functions are available with the projector.

- **Control Panel Lock**  
This is useful at events or shows when you want to deactivate all buttons during projection or at schools when you want to limit button operation.
- **Lens Operation Lock**  
This function deactivates all buttons on the remote control related to the lens operation to prevent improper lens adjustment after it is properly adjusted.
- **Remote Control Button Lock**  
This function deactivates buttons except for the main buttons needed for basic remote control operation, to prevent mistakes in operations.

### Control Panel Lock

Perform one of the following to lock the operation buttons on the control panel. Even if the control panel is locked, you can still use the remote control as usual.

- **Full Lock**  
All of the buttons on the control panel are locked. You cannot perform any operations from the control panel, including turning the power on or off.
- **Control Panel Lock**  
All of the buttons on the control panel, except for the [⏻] button, are locked.

- 1 Press the [🔒] button on the control panel during projection to display the Control Panel Lock screen.



You can also make settings in **Control Panel Lock** in the Configuration menu.

☛ **Settings - Control Panel Lock** p.121

- 2 Select either **Full Lock** or **Partial Lock** according to your purpose.

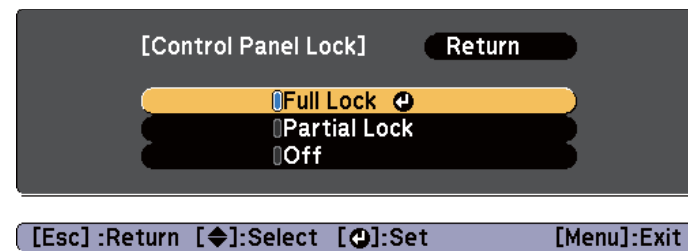

- 3 Select **Yes** when the confirmation message is displayed.  
The control panel buttons are locked according to the setting you chose.



You can release the control panel lock by one of the following two methods.

- Use the remote control to set **Control Panel Lock** to **Off** in the Configuration menu.  
☛ **Settings - Control Panel Lock** p.121
- Press and hold down the [↵] button on the control panel for about seven seconds, a message is displayed and the lock is released.

## Lens Operation Lock

This function locks the following buttons on the remote control related to the lens operation.

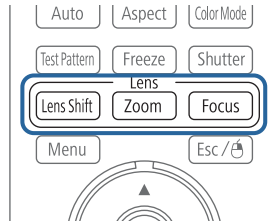

Set the **Lens Operation Lock** to **On** in the Configuration menu.

☛ **Settings - Lens Operation Lock** [p.121](#)

## Remote Control Button Lock

This function locks the following buttons on the remote control.

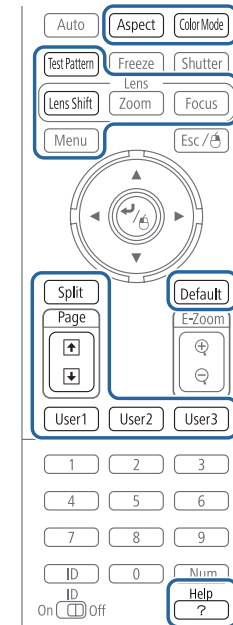

Each time the [Help] button is pressed for at least 5 seconds, the remote control button lock turns on or off.

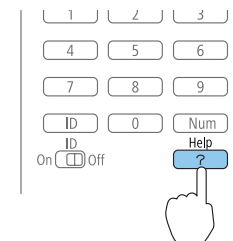



Even if the remote control button lock is on, the following operations are possible.

- Resetting default for the Remote Receiver setting
- Releasing the remote control button lock

## Anti-Theft Lock

The projector is equipped with the following types of anti-theft security devices.

- Security slot

The security slot is compatible with the Microsaver Security System manufactured by Kensington.

See the following for more details on the Microsaver Security System.

☞ <http://www.kensington.com/>

- Handles

A commercially available theft-prevention wire lock can be passed through the handle to secure the projector to a desk or pillar.

### Installing the wire lock

Pass an anti-theft wire lock through the handle.

See the documentation supplied with the wire lock for locking instructions.

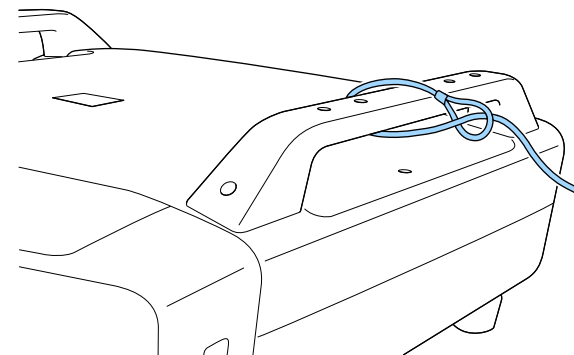





# Configuration Menu

This chapter explains how to use the Configuration menu and its functions.

This section explains how to use the Configuration menu.

Although steps are explained using the remote control as an example, you can perform the same operations from the control panel. Check the guide under the menu for the available buttons and their operations.

## 1 Display the Configuration menu screen.

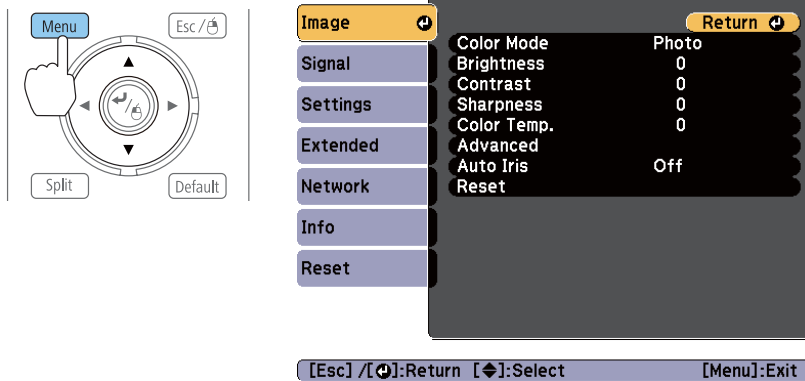

## 2 Select a top menu item.

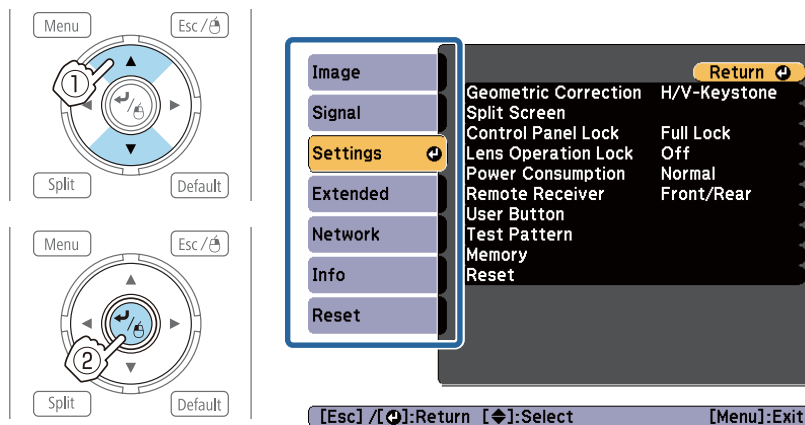

## 3 Select a submenu item.

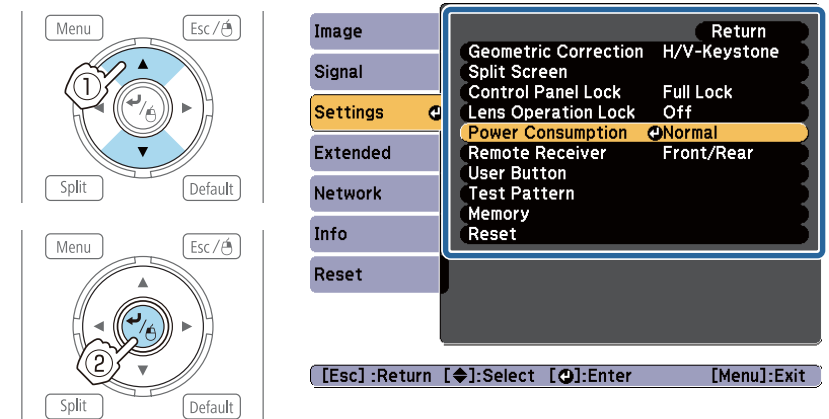

## 4 Change settings.

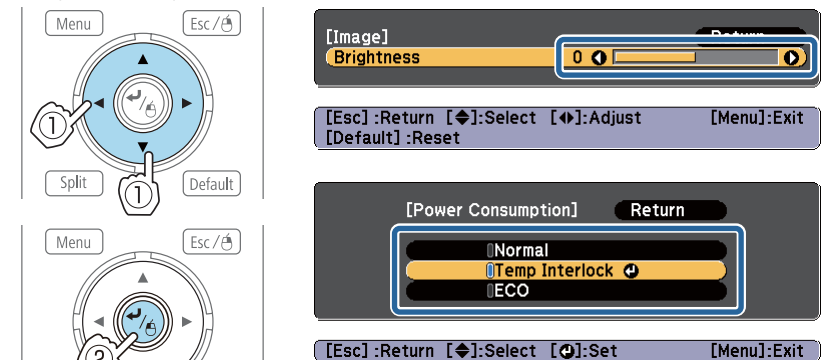





When **Default: Reset** is displayed on the guide, and you press the [Default] button on the remote control, the settings being adjusted are returned to their default values.



## 5 Press the [Menu] button to finish making settings.

## Configuration Menu Table





Settable items vary depending on the model being used and the image signal and source being projected.

Top Menu Name	Submenu Name	Items or Setting Values
Image Menu  p.117	Color Mode	Dynamic, Presentation, Theatre, Photo, Sports, sRGB, DICOM SIM, Multi-Projection, 3D Dynamic, 3D Presentation, 3D Theatre, 3D Multi-Projection
	Brightness	-24 to 24
	Contrast	-24 to 24
	Color Saturation	-32 to 32
	Tint	-32 to 32
	Sharpness	-5 to 5, Advanced
	Color Temp.	3200K, 5000K to 10000K, -3 to 6
	Advanced	Gamma, RGB, RGBCMY
	Auto Iris	Off, Normal, High Speed
Signal Menu  p.119	3D Setup	3D Images
	Auto Setup	On, Off
	Resolution	Auto, Wide, Normal, Manual
	Tracking	-
	Sync.	-
	Position	-
	Progressive	Off, Video, Film/Auto
	Frame Interpolation	Off, Low, Normal, High
	Super-resolution	0 to 3
	Noise Reduction	Off, NR1, NR2
Mosquito NR	On, Off	

Top Menu Name	Submenu Name	Items or Setting Values
	Video Range	Auto, Normal, Expanded
	Input Signal	Auto, RGB, Component
	Video Signal	Auto, NTSC, NTSC4.43, PAL, M-PAL, N-PAL, PAL60, SECAM
	Aspect	Auto, Normal, 4:3, 16:9, Full, Zoom, Native
	Scale	-
	Overscan	Auto, Off, 4%, 8%
Settings menu  p.121	Image Processing	Fine, Fast
	Geometric Correction	Off, H/V-Keystone, Quick Corner, Curved Surface, Point Correction, Corner Wall
	Split Screen	-
	Control Panel Lock	Full Lock, Partial Lock, Off
	Lens Operation Lock	On, Off
	Power Consumption	Normal, Temp Interlock, ECO
	Remote Receiver	Front/Rear, Front, Rear, Off
	User Button	User Button 1, User Button 2, User Button 3
	Test Pattern	-
	Memory	Load Memory, Save Memory, Erase Memory, Rename Memory
Extended Menu  p.122	Display	Menu Position, Message Position, Messages, Display Background, Startup Screen, Standby Confirmation, Air Filter Notice, Screen, Panel Alignment, Color Uniformity
	User's Logo	-

Top Menu Name	Submenu Name	Items or Setting Values
	Projection	Front, Front/Upside Down, Rear, Rear/Upside Down
	Direction	Normal, Pointing Up, Pointing Down, Angled Up, Angled Down
	Operation	Direct Power On, Sleep Mode, Sleep Mode Timer, Shutter Timer, High Altitude Mode, Startup Source Search, Auto Power On, Advanced, Date & Time
	A/V Settings	A/V Output, Monitor Out
	Standby Mode	Communication On, Communication Off
	HDBaseT	Communication On, Extron XTP
	Multi-Projection	Projector ID, Scale, Color Mode, Color Uniformity, Edge Blending, Brightness Level, Color Matching, RGBCMY, Black Level
	Lamp Select	Dual, Single, Lamp 1, Lamp 2
	Schedule Settings	-
	Language	27 languages
	Info menu  p.136	Projector Info
Lamp Info		Lamp Hours, Lamp Status
Version		Main, Video, Status Monitor
Reset Menu  p.138	Reset All	-
	Reset Memory	-

## Network Menu

Top Menu Name	Submenu Name	Items or Setting Values
Basic menu  p.129	Projector Name	-
	PJLink Password	-
	Web Control Password	-
Wireless LAN menu  p.130	Projector Keyword	On, Off
	Wireless LAN Power	On, Off
	Connection Mode	Quick, Advanced
	Channel	1ch, 6ch, 11ch
	SSID Auto Setting	On, Off
	SSID	-
	Search Access Point	-
	IP Settings	DHCP, IP Address, Subnet Mask, Gateway Address
	SSID Display	On, Off
Security menu  p.132	IP Address Display	On, Off
	Security	Off, WPA2-PSK, WPA/WPA2-PSK
Wired LAN menu  p.133	Passphrase	-
	IP Settings	DHCP, IP Address, Subnet Mask, Gateway Address
Mail menu  p.134	IP Address Display	On, Off
	Mail Notification	On, Off
	SMTP Server	-
	Port Number	-
	Address 1 Setting, Address 2 Setting, Address 3 Setting	-

Top Menu Name	Submenu Name	Items or Setting Values
Others menu ☛ p.135	SNMP	On, Off
	Trap IP Address 1 and Trap IP Address 2	-
	Priority Gateway	Wired LAN, Wireless LAN
	AMX Device Discovery	On, Off
	Crestron RoomView	On, Off
	Bonjour	On, Off
	Message Broadcasting	On, Off

## Image Menu

Settable items vary depending on the image signal and source currently being projected. Setting details are saved for each image signal.

☛ "Automatically Detect Input Signals and Change the Projected Image (Search)" p.58

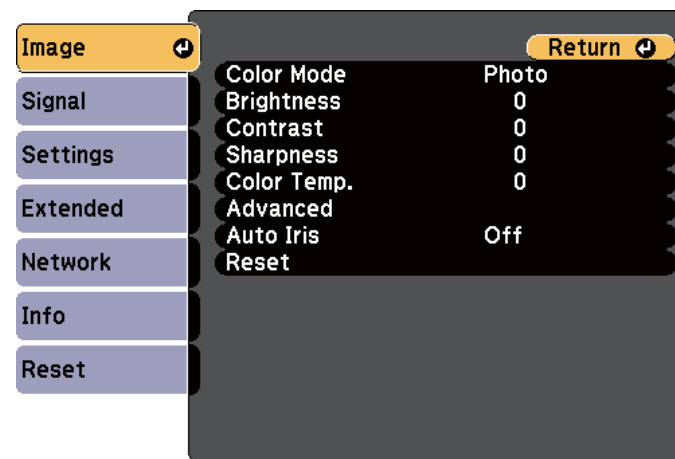

[Esc] / [⏪]:Return [⏩]:Select [Menu]:Exit

Submenu	Function
<b>Color Mode</b>	Select the quality of the image to suit your surroundings. ☛ "Selecting the Projection Quality (Selecting Color Mode)" p.70
<b>Brightness</b>	Adjusts the image brightness.
<b>Contrast</b>	Adjusts the difference between light and shade in the images.
<b>Color Saturation</b>	(Adjustment is only possible when component video or composite video images are being input.) Adjusts the color saturation for the images.

Submenu	Function
<b>Tint</b>	(Adjustment is possible when component video signals are being input. Composite video and S-video input signals can only be adjusted when they are NTSC video signals.) Adjusts the image tint.
<b>Sharpness</b>	(Only <b>Standard</b> can be set when <b>Image Processing</b> is set to <b>Fast</b> .) <b>Standard:</b> You can adjust the image sharpness. To make more-detailed settings, select <b>Advanced</b> . <b>Advanced:</b> The following four items can be set. <b>Thin Line Enhancement:</b> If this parameter is set to a positive value, details such as hair or fabric patterns are enhanced. <b>Thick Line Enhancement:</b> If this parameter is set to a positive value, the outline, background, and the other main parts of the objects in the image are enhanced to show them clearly. <b>Vert. Line Enhancement:</b> If this parameter is set to a positive value, vertical lines in the image are enhanced. <b>Horiz. Line Enhancement:</b> If this parameter is set to a positive value, horizontal lines in the image are enhanced.
<b>Color Temp.</b>	You can adjust the overall tint of the image. When the <b>Color Mode</b> is set to <b>sRGB</b> or <b>DICOM SIM</b> , adjust to 11 steps in 3200K, 5000K to 10000K. When the <b>Color Mode</b> is set to other settings, you can adjust it in a range of -3 to 6. The image is tinted blue when a high value is selected and tinted red when a low value is selected.
<b>Advanced</b>	You can make adjustments by choosing the following items. <b>Gamma:</b> You can adjust the coloring by selecting one of the gamma correction values, or referring to the projected image or a gamma graph. <b>RGB:</b> c <b>RGBCMY:</b> You can adjust the hue, saturation, and brightness of each color R (red), G (green), B (blue), C (cyan), M (magenta), Y (yellow) individually.

Submenu	Function
<b>Auto Iris</b>	(This item can be set only if <b>Color Mode</b> is set to <b>Dynamic</b> , <b>Theatre</b> , <b>3D Dynamic</b> or <b>3D Theatre</b> . It cannot be set if <b>Edge Blending</b> is set to <b>On</b> .) Set to <b>Normal</b> or <b>High Speed</b> to adjust the iris to obtain the optimum light for images being projected. Select <b>High Speed</b> to make faster iris corrections to match the speed of the scene. The setting is stored for each Color Mode.
<b>Reset</b>	You can reset all adjustment values for the <b>Image</b> menu to their default settings. See the following to return all menu items to their default settings.  "Reset Menu" <a href="#">p.138</a>

## Signal Menu

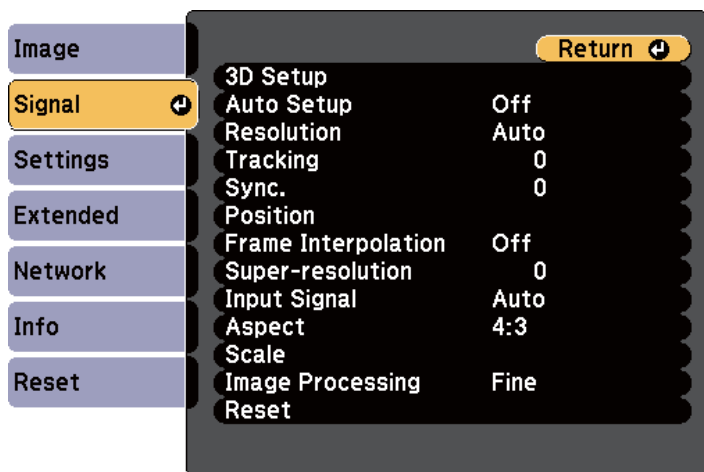

Settable items vary depending on the image signal and source currently being projected. Setting details are saved for each image signal.



[Esc] / [Return]: Return [Left/Right]: Select [Menu]: Exit

Submenu	Function
<b>3D Setup</b>	When projecting passive 3D images using two projectors, set <b>3D Images</b> to <b>On</b> .
<b>Auto Setup</b>	(Only available when an analog RGB computer signal is being input.) Set to <b>On</b> to automatically adjust Tracking, Sync., and Position to the optimum state when the input signal changes.

Submenu	Function
<b>Resolution</b>	(Only available when an analog RGB computer signal is being input.) Set to <b>Auto</b> to automatically identify the resolution of the input signal. If images are not projected correctly when set to <b>Auto</b> , for example if some of the image is missing, set to <b>Wide</b> for wide screens, or set to <b>Normal</b> for 4:3 or 5:4 screens depending on the connected computer. <b>Manual</b> allows you to specify the resolution. This is ideal when the connected computer is always the same.
<b>Tracking</b>	(Only available when an analog RGB computer signal is being input.) You can adjust computer images when vertical stripes appear in the images.
<b>Sync.</b>	(Only available when an analog RGB computer signal is being input.) You can adjust computer images when flickering, fuzziness, or interference appears in the images.
<b>Position</b>	You can adjust the display position up, down, left, and right when a part of the image is missing so that the whole image is projected.
<b>Progressive</b>	<u>Interlace</u> (i) signal is converted to <u>Progressive</u> (p). (IP conversion) <b>Off</b> : Ideal for images with a large amount of movement. <b>Video</b> : Ideal for general video images. <b>Film/Auto</b> : This is ideal for movie films, computer graphics, and animation.
<b>Frame Interpolation</b> (EB-Z10005U/ EB-Z10000U/ EB-Z9875U/ EB-Z9870U/ EB-Z9750U only)	You can play fast moving images smoothly by producing intermediate frames between the original frames.





Submenu	Function
<b>Super-resolution</b>	To display a crisp image, you can reduce the blurring that is created on the edge when the image data is scaled up to fit the panel resolution of the image signal.
<b>Noise Reduction</b>	(This cannot be set when <b>Image Processing</b> is set to <b>Fast</b> .) Smooths out the roughness in progressive images. There are two modes. Select the setting that best suits your environment. It is recommended that this is set to <b>Off</b> when viewing image sources in which noise is very low, such as for DVDs.
<b>Mosquito NR</b>	(This cannot be set when <b>Image Processing</b> is set to <b>Fast</b> .) When a progressive signal is being input, you can reduce the wavy noise that occurs in lines between areas with dramatic changes in colors.
<b>Video Range</b>	Select the video range for the input signal from the HDMI input port, the DVI-D input port, HDBaseT port, or the SDI input port. Set to <b>Expanded</b> if you are concerned about misadjusted black levels or blown out highlights in the image.
<b>Input Signal</b>	You can select an input signal from the Computer input port or BNC input port. If set to <b>Auto</b> , the input signal is set automatically according to the connected equipment. If colors do not appear correctly when set to <b>Auto</b> , select the appropriate signal according to the connected equipment.
<b>Video Signal</b>	You can select an input signal from the Video input port or S-Video input port. If set to <b>Auto</b> , video signals are recognized automatically. If interference appears in the image or a problem occurs such as no image is being projected when set to <b>Auto</b> , select the appropriate signal according to the connected equipment.
<b>Aspect</b>	You can set the <u>aspect ratio</u>  for projected images.  "Changing the Aspect Ratio of the Projected Image" <a href="#">p.72</a>
<b>Scale</b>	When using multiple projectors to project one image, adjust the range of the image displayed by each projector.  "Combining Scaled Images" <a href="#">p.89</a>

Submenu	Function
<b>Overscan</b>	(This setting can only be adjusted when a Component Video signal or RGB-Video signal is being input.) Changes the output image ratio (the range of the projected image). You can set the cropping range to <b>4%</b> or <b>8%</b> . When set to <b>Auto</b> , this is automatically adjusted according to the input signal.
<b>Image Processing</b>	Changes settings for image processing. <b>Fine:</b> Images are displayed in higher quality. <b>Fast:</b> Images are displayed quicker.
<b>Reset</b>	You can reset all adjustment values on the <b>Signal</b> menu to their default settings, except for <b>Input Signal</b> and <b>Image Processing</b> . See the following to return all menu items to their default settings.  "Reset Menu" <a href="#">p.138</a>

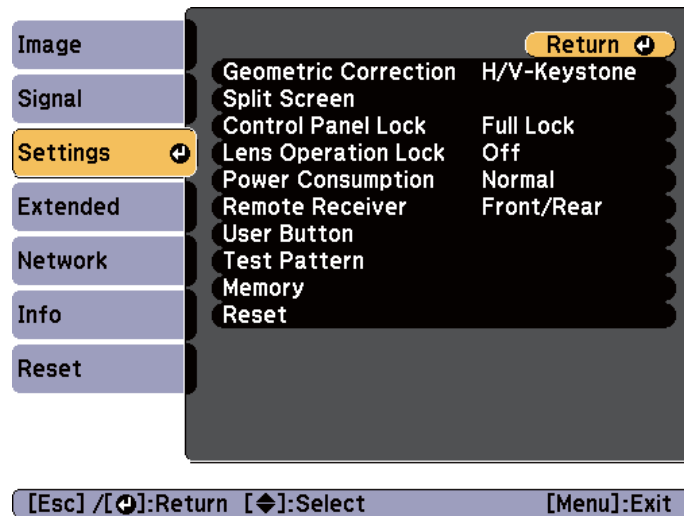

## Settings Menu



Submenu	Function
<b>Geometric Correction</b>	<p>You can correct distortion.</p> <p> "Correcting Distortion in the Projected Image" <a href="#">p.60</a></p> <ul style="list-style-type: none"> <li>• <b>Off:</b> Temporarily cancels the geometric correction.</li> <li>• <b>H/V-Keystone:</b> Adjust <b>V-Keystone</b> and <b>H-Keystone</b> to correct vertical and horizontal keystone distortion.</li> <li>• <b>Quick Corner:</b> Select and correct the four corners of the projected image.</li> <li>• <b>Curved Surface:</b> Corrects distortion that occurs when projecting on a curved surface.</li> <li>• <b>Point Correction:</b> Divides the projected image into a grid and corrects the distortion by moving the selected point of intersection from side to side and up and down.</li> <li>• <b>Corner Wall:</b> Corrects distortion that occurs when projecting on a surface with right angles.</li> </ul>
<b>Split Screen</b>	<p>You can split the screen into two screens.</p> <p> "Projecting Two Images Simultaneously (Split Screen)" <a href="#">p.91</a></p>
<b>Control Panel Lock</b>	<p>You can restrict operation of the projector's control panel.</p> <p> "Control Panel Lock" <a href="#">p.110</a></p>
<b>Lens Operation Lock</b>	<p>You can restrict the lens operation of the remote control.</p> <p> "Lens Operation Lock" <a href="#">p.111</a></p>
<b>Power Consumption</b>	<p>(Disabled during portrait projection.)</p> <p>When set to <b>Normal</b>, the lamp is at its brightest.</p> <p>When set to <b>Temp Interlock</b>, if the surrounding temperature* gets too high, the lamp automatically dims to control the operating temperature.</p> <p>When set to <b>ECO</b>, the power consumption during projection drops and the fan noise is reduced.</p>

Submenu	Function
<b>Remote receiver</b>	You can limit the reception of the operation signal from the remote control. When set to <b>Off</b> , you cannot perform any operations from the remote control. If you want to make operations from the remote control, hold down the [Menu] button on the remote control for at least 15 seconds to reset the setting to its default value.
<b>User Button</b>	Select the items in the Configuration menu that you want to assign to the [User1], [User2], and [User3] buttons on the remote control. The following items can be assigned. <b>Power Consumption, Info, Progressive, Geometric Correction, Multi-Projection, Resolution, Memory, Image Processing, or On-Screen Display</b>
<b>Test Pattern</b>	You can display a test pattern to adjust the projection without connecting other equipment when you set up the projector. ☛ "Displaying a Test Pattern" <a href="#">p.34</a>
<b>Memory</b>	Perform operations and make settings for the memory function. ☛ "Memory Function" <a href="#">p.98</a>
<b>Reset</b>	You can reset all adjustment values on the <b>Settings</b> menu to their default settings, except for <b>User Button</b> and <b>Memory</b> . See the following to return all menu items to their default settings. ☛ "Reset Menu" <a href="#">p.138</a>

\* Operating temperature of +45°C at an altitude of 0 to 1,499 m, and +40°C at an altitude of 1,500 to 3,048 m.

## Extended Menu

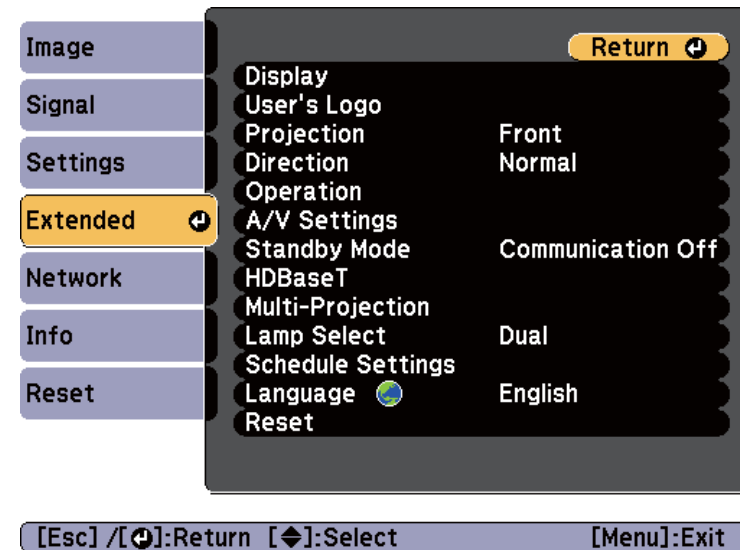





Submenu	Function
<b>Display</b>	<p>You can make settings related to the projector's display.</p> <p><b>Menu Position:</b> Select the position to display the menu on the projected screen.</p> <p><b>Message Position:</b> Select the position to display the message on the projected screen.</p> <p><b>Messages:</b> When set to <b>Off</b>, the following items will not be displayed.</p> <p>Item names when the Source, Color Mode, or Aspect is changed, messages when no signal is being input, and warnings such as High Temp Warning.</p> <p><b>Display Background*:</b> You can set the screen background to <b>Black</b>, <b>Blue</b>, or <b>Logo</b> when no image signal is available.</p> <p><b>Startup Screen*:</b> Set to <b>On</b> to display the <b>User's Logo</b> when you turn on the projector.</p> <p><b>Standby Confirmation:</b> (This item can be set when the <b>Remote Control Type</b> is set to <b>Simple</b>.) When set to <b>On</b> (default), a confirmation message is displayed asking whether or not to turn off the power when the [⏻] button is pressed. Press the [⏻] button again to turn the power off.</p> <p>If it is set to <b>Off</b>, you can turn off the power simply by pressing the [⏻] button once.</p> <p><b>Air Filter Notice:</b> Set whether or not to enable the Air Filter Notice function. When this is set to <b>On</b> and a clog in the air filter is detected, the message is displayed on the screen.</p> <p><b>Screen:</b> (This item cannot be set when projecting images from a computer over a network.) Set the aspect ratio and position of the projected screen according to the screen being used.</p> <p>☛ "Screen Settings" <a href="#">p.32</a></p> <p><b>Panel Alignment:</b> Correct color misalignments (red and blue) in the screen.</p> <p>☛ "Panel Alignment" <a href="#">p.181</a></p> <p><b>Color Uniformity:</b> Adjusts the color tone balance for the whole screen.</p>









Submenu	Function
	☛ "Color Uniformity" <a href="#">p.183</a>
<b>User's Logo*</b>	<p>Change the User's Logo to display when the power is turned on or the image signal is not input.</p> <p>☛ "Saving a User's Logo" <a href="#">p.96</a></p>
<b>Projection</b>	<p>Select from one of the following projection methods depending on how the projector is installed.</p> <p><b>Front, Front/Upside Down, Rear, and Rear/Upside Down</b></p> <p>☛ "Changing the direction of the image (Projection)" <a href="#">p.31</a></p>
<b>Direction</b>	<p>Set this parameter according to the installation angle of the projector.</p> <p>☛ "Installation Settings" <a href="#">p.30</a></p>



Submenu	Function
Operation	<p><b>Direct Power On:</b> Set to <b>On</b> to turn on the projector simply by plugging it in. When the power cord is plugged in, note that the projector turns on automatically in cases such as a power outage being restored.</p> <p><b>Sleep Mode:</b> When set to <b>On</b>, this automatically stops projection when no image signal is being input and no operations are carried out.</p> <p><b>Sleep Mode Timer:</b> When <b>Sleep Mode</b> is set to <b>On</b>, you can set the time before the projector automatically turns off within a range of 1 to 30 minutes.</p> <p><b>Shutter Timer:</b> When set to <b>On</b>, this automatically turns off the projector when no operations are carried out for approximately 120 minutes while the shutter function is activated.</p> <p><b>High Altitude Mode:</b> Set to <b>On</b> when using the projector above an altitude of 1,500 m.</p> <p><b>Startup Source Search:</b> Set whether or not (<b>On/Off</b>) to automatically detect the image signal being input when the projector is turned on.</p> <p><b>Auto Power On:</b> (Only available when <b>Standby Mode</b> is set to <b>Communication On</b>.) If it is set to <b>Computer</b> or <b>BNC</b>, the projector is turned on when the signals are received from the Computer input port or BNC input port, even when the projector is in standby status.</p>

Submenu	Function
Operation	<p><b>Advanced:</b> The following items can be set.</p> <ul style="list-style-type: none"> <li>• <b>BNC Sync Termination:</b> Set the termination for the signal from the BNC input port. This should usually be set to <b>Off</b>. Set to <b>On</b> when analog (75Ω) termination such as for switchers is necessary.</li> <li>• <b>Remote Control Type:</b> You can select <b>Normal</b> or <b>Simple</b> depending on the type of remote control. Set this item to <b>Normal</b> to use the remote control provided with this projector. When <b>Simple</b> is selected, you can use the remote control provided with other Epson projectors to operate this projector. This is useful if you want to use a remote control that you are already familiar with to operate the projector. However, you cannot use the remote control provided with this projector if this is set to <b>Simple</b>. Make sure that the setting is correct because, if the projector is installed on the ceiling or somewhere hard to reach, changing it back to <b>Normal</b> may be difficult. Additionally, you cannot use functions that are not equipped with this projector or the remote control that you are using.</li> <li>• <b>Shutter Button:</b> Select an operation to perform when the [Shutter] button is pressed. When <b>Shutter</b> is selected, the electric shutter opens/closes. When <b>Blank</b> is selected, this turns off the image temporarily.</li> <li>• <b>Shutter Release:</b> If it is set to <b>Shutter</b>, it is only released by pressing the [Shutter] button, (or by sending a command to release the shutter function). When set to <b>Any Button</b>, the shutter function is released when any operation is performed on the projector. <ul style="list-style-type: none"> <li>☛ "Hiding the Image Temporarily (Shutter)" p.94</li> </ul> </li> <li>• <b>Beep:</b> When set to <b>Off</b>, the confirmation buzzer does not beep to notify you that the power turns on or off, or cooling down is finished.</li> <li>• <b>Indicators:</b> When set to <b>Off</b>, the projector's indicators are turned off, except for error or warning.</li> </ul>

Submenu	Function
Operation	<ul style="list-style-type: none"> <li>• <b>Lens Type:</b> Select the model number for the lens you are using. Select ELPLS04 for the projector that has a built-in lens.</li> <li>• <b>Instant Off:</b> When set to <b>Enabled</b>, the projector goes into standby status in approximately three seconds after power off. If you turn the power on immediately after turning it off, command communication may be cut off. To stabilize command communication, set this to <b>Disabled</b>. When set to <b>Disabled</b>, the projector goes into standby status in approximately 170 seconds after power off.</li> <li>• <b>Date &amp; Time:</b> Make system time settings for the projector.   "Setting the Time" p.100</li> </ul>
A/V Settings	<p><b>A/V Output:</b> (Only available when <b>Communication On</b> is set for <b>Standby Mode</b>.) When set to <b>Always On</b>, you can perform the following operations even if the projector is in standby mode.</p> <ul style="list-style-type: none"> <li>• Output images to an external monitor.</li> <li>• Use the status monitor.</li> </ul> <p><b>Monitor Out:</b> Select the image source output to an external monitor when the projector is in standby status. When set to <b>Auto</b>, analog RGB signals from the Computer input port or the BNC input port are output depending on which source was selected when the projector was turned off.</p>

Submenu	Function
Standby Mode	<p>(This item cannot be set when <b>Extron XTP</b> is set to <b>On</b>.)  If you set <b>Communication On</b>, you can perform the following operations even if the projector is in standby mode.</p> <ul style="list-style-type: none"> <li>• Monitor and control the projector over a network.</li> <li>• Output audio and images to an external device. (Only when <b>A/V Output</b> is set to <b>Always On</b>.)</li> <li>• Use the status monitor. (Only when <b>A/V Output</b> is set to <b>Always On</b>.)</li> <li>• Communication from the HDBaseT port is enabled. (Only when <b>Control Communications</b> is set to <b>On</b>.)</li> <li>• Start projection by inputting an image signal. (Only available when <b>Auto Power ON</b> is set to <b>On</b>.)</li> </ul> <div style="border: 1px solid black; padding: 5px; margin-top: 10px;">  When monitoring or controlling the projector over the network using wireless LAN, set <b>Connection Mode</b> to <b>Advanced</b>.   <b>Network - Wireless LAN - Connection Mode</b> p.130 </div>
HDBaseT	<p><b>Control Communications</b> (This cannot be set when <b>Extron XTP</b> is set to <b>On</b>.) When set to <b>On</b>, Ethernet communication, serial communication, and the wired remote control through the HDBaseT Transmitter connected to the HDBaseT port are all enabled. (When this is enabled, the projector's LAN port, RS-232C port, and Remote port are disabled.)</p> <p><b>Extron XTP:</b> Set to <b>On</b> when you connect the Extron XTP transmitter or switcher to the HDBaseT port. See the following Extron Web site for more details on the XTP system.  <a href="http://www.extron.com/">http://www.extron.com/</a></p> <div style="border: 1px solid black; padding: 5px; margin-top: 10px;">  When <b>Extron XTP</b> is set to <b>On</b>, the fan may rotate in standby mode but this is not abnormal. </div>

Submenu	Function
<b>Multi-Projection</b>	<p>Make settings when projecting from multiple projectors.   "Multi-Projection Function" <a href="#">p.80</a></p> <p><b>Projector ID:</b> Set the ID from 1 to 9. <b>Off</b> indicates that no ID is set.   "ID Settings" <a href="#">p.39</a></p> <p><b>Scale:</b> When using multiple projectors to project one image, adjust the range of the image displayed by each projector.   "Combining Scaled Images" <a href="#">p.89</a></p> <p><b>Color Mode:</b> Set to <b>Multi-Projection</b> (or <b>3D Multi-Projection</b> for projecting 3D images).</p> <p><b>Color Uniformity:</b> Adjusts the color tone balance for the whole screen.   "Color Uniformity" <a href="#">p.183</a></p> <p><b>Edge Blending:</b> Corrects a border between multiple images to create a seamless screen.   "Adjust the overlapping area of the images (Edge Blending)" <a href="#">p.81</a></p> <p><b>Brightness Level:</b> When the brightness of each lamp differs, set the lamp brightness level between 1 and 5. This item can be adjusted only when <b>Power Consumption</b> is set to <b>Normal</b> in the <b>Settings</b> menu.   "Correcting the brightness" <a href="#">p.83</a></p> <p><b>Color Matching:</b> Corrects the difference between the tint and brightness of each projected image.   "Color Matching" <a href="#">p.85</a></p> <p><b>RGBCMY:</b> You can adjust the Hue, Saturation, and Brightness for R (red), G (Green), B (Blue), C (Cyan), M (Magenta), and Y (Yellow) color components.   "Adjusting RGBCMY" <a href="#">p.86</a></p> <p><b>Black Level:</b> Adjusts the differences in brightness and tone for areas where images overlap and areas where the images do not overlap.   "Black Level" <a href="#">p.86</a></p> <p><b>Reset:</b> You can reset all adjustment values for the <b>Multi-Projection</b> menu to their default settings.</p>

Submenu	Function
<b>Lamp Select</b>	<p>Select the lamps to be turned on.   "Selecting the lamp" <a href="#">p.31</a></p>
<b>Schedule Settings</b>	<p>You can set the projector's schedule so that it performs a specific operation at a specified date and time.   "Scheduling Function" <a href="#">p.100</a></p>
<b>Language</b>	<p>You can set the language for messages and menus.</p>
<b>Reset</b>	<p>You can reset all adjustment values for the <b>Extended</b> menu to their default settings. However, the following items are not reset.  <b>Screen Type, Screen Position, Projection, Direction, High Altitude Mode, Startup Source Search, Remote Control Type, Shutter Release, Lens Type, A/V Output, Monitor Out, Standby Mode, Control Communications, Projector ID, Color Matching, Lamp Select, Language</b>            See the following to return all menu items to their default settings.   "Reset Menu" <a href="#">p.138</a></p>

\* When **User's Logo Protection** is set to **On** in **Password Protection**, you cannot change settings related to user's logo. You can make changes after setting **User's Logo Protection** to **Off**.

 "Managing Users (Password Protection)" [p.107](#)

## Network Menu

When **Network Protection** is set to **On** in **Password Protection**, a message is displayed and the network settings cannot be changed. Set **Network Protection** to **Off** and then configure the network.

☛ "Setting Password Protection" [p.108](#)

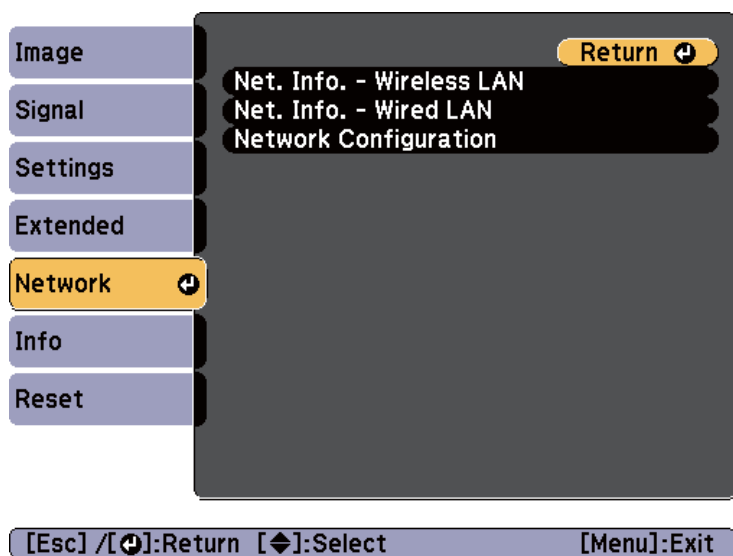

Submenu	Function
<b>Net. Info. - Wireless LAN</b>	Displays the following network setting status information. <ul style="list-style-type: none"> <li>• Connection Mode</li> <li>• Wireless LAN System</li> <li>• Antenna Level</li> <li>• Projector Name</li> <li>• SSID</li> <li>• DHCP</li> <li>• IP Address</li> <li>• Subnet Mask</li> <li>• Gateway Address</li> <li>• MAC Address</li> <li>• Region Code*</li> </ul>
<b>Net. Info. - Wired LAN</b>	Displays the following network setting status information. <ul style="list-style-type: none"> <li>• Projector Name</li> <li>• DHCP</li> <li>• IP Address</li> <li>• Subnet Mask</li> <li>• Gateway Address</li> <li>• MAC Address</li> </ul>
<b>Network Configuration</b>	The following menus are available for setting network items. <b>Basic, Wireless LAN, Security, Wired LAN, Mail, Others, Reset, Complete</b>

\* Displays available region information for the wireless LAN unit being used. For more details, contact your local dealer or the nearest address provided in the Epson Projector Contact List.

☛ [Epson Projector Contact List](#)



- By using a Web browser of a computer connected to the projector on a network, you can set functions and control the projector. This function is called Web Control. You can easily enter text using a keyboard to make settings for Web Control such as security settings.
  - ☛ "Changing Settings Using a Web Browser (Web Control)" [p.186](#)
- Contact your network administrator for details on network settings.

## Notes on operating the Network menu

Selecting from the top menu and sub menus, and changing selected items is the same as making operations from the Configuration menu.

When done, make sure you go to the **Complete** menu, and select **Yes**, **No**, or **Cancel**. When you select **Yes** or **No**, you are returned to the Configuration menu.

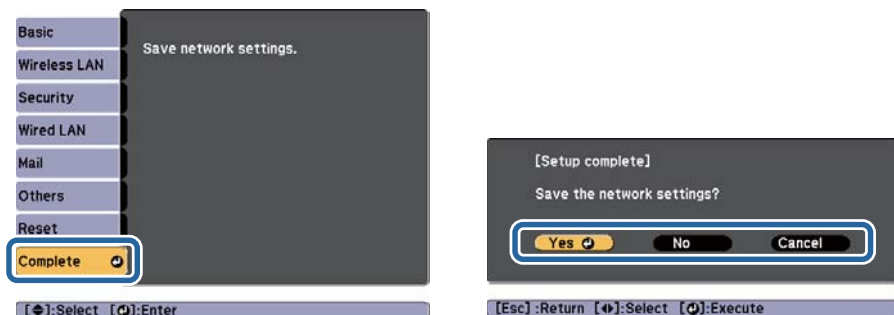

**Yes:** Saves the settings and exits the Network menu.

**No:** Exits to the Network menu without saving the settings.

**Cancel:** Continues displaying the Network menu.

## Soft keyboard operations

The Network menu contains items that require entry of alphanumeric characters during setup. In this case, the following software keyboard is displayed. Press the [▲][▼][◀][▶] buttons on the remote control or control panel to move the cursor to the desired key, and then press the [↵] button to enter the selected character. Enter figures by holding down the [Num] button on the remote control, and pressing the numeric buttons. After entering, press **Finish** on the keyboard to confirm your entry. Press **Cancel** on the keyboard to cancel your entry.

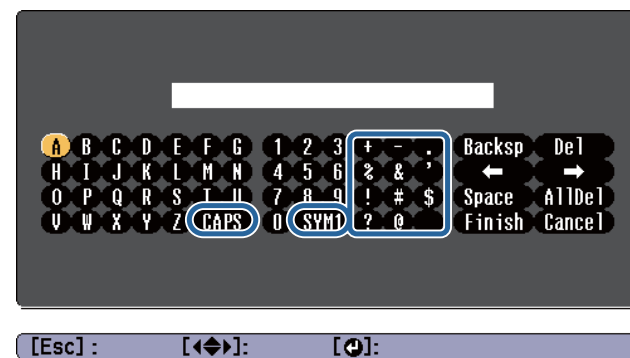

- Each time the **CAPS** key is selected and the [↵] button is pressed, it sets and changes between upper case and lower case letters.
  - Each time the **SYM1/2** key is selected and the [↵] button is pressed, it sets and changes the symbol keys for the section enclosed by the frame.
- The following types of character can be entered.

Numbers	0123456789
Letters	ABCDEFGHIJKLMNOPQRSTUVWXYZ abcdefghijklmnopqrstuvwxyz
Symbols	! # \$ % & ' ( ) + - . / < = > ? @ ^ _ ` {   } ~





- : Except for the **SSID**, colons and spaces cannot be entered on the Network menu.
- Some symbols (" \* , ; [ \ ] ) cannot be entered using the software keyboard. Enter these characters using a Web browser.
- ☛ "Changing Settings Using a Web Browser (Web Control)"  
p.186

## Basic menu

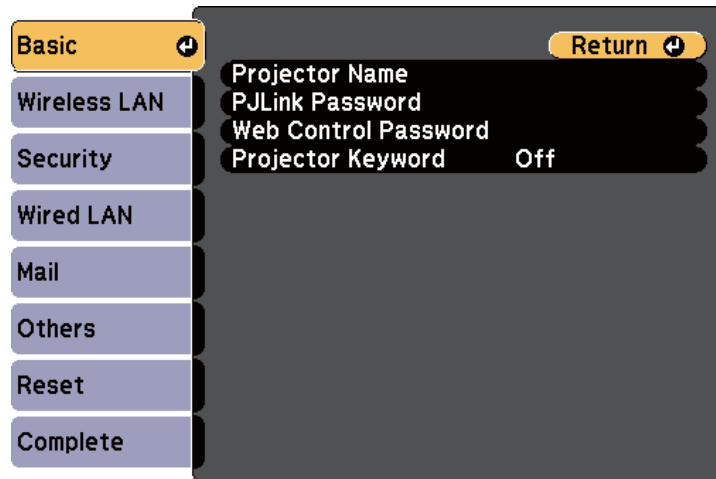

[Esc] / [⏪]:Return [⏩]:Select



Submenu	Function
<b>Web Control Password</b>	<p>Set a password to use when making settings and controlling the projector using Web Control. You can enter up to eight single-byte alphanumeric characters (* cannot be used). The default password is "admin".</p> <p>Web Control is a computer function that allows you to set up and control the projector by using the Web browser on a computer connected on a Network.</p> <p>☛ "Changing Settings Using a Web Browser (Web Control)" p.186</p>
<b>Projector Keyword</b>	<p>When set to <b>On</b>, you have to enter the keyword when you try to connect the projector to a computer via a network. This allows you to prevent presentations from being interrupted by connections from other computers.</p> <p>Normally this should be set to <b>On</b>.</p> <p>☛ <a href="#">EasyMP Network Projection Operation Guide</a></p> <p>☛ <a href="#">EasyMP Multi PC Projection Operation Guide</a></p>

Submenu	Function
<b>Projector Name</b>	<p>Displays the projector name used to identify the projector when connected to a network.</p> <p>When editing, you can enter up to 16 single-byte alphanumeric characters. The following characters cannot be used: " * + , / ; &lt; = &gt; ? [ \ ] `  </p>
<b>PLink Password</b>	<p>Set a password to use when you access the projector using compatible PLink software. You can enter up to 32 single-byte alphanumeric characters (symbols cannot be used).</p>

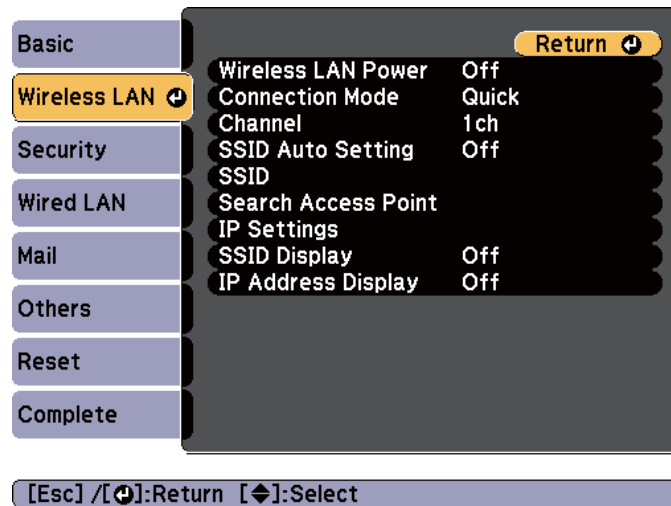
## Wireless LAN Menu



Submenu	Function
Wireless LAN Power	Set to <b>On</b> when connecting the projector to the computer over wireless LAN. If you do not want to connect over wireless LAN, set to <b>Off</b> to prevent unauthorized access by others. This is set to <b>On</b> by default.



Submenu	Function
Connection Mode	Set the connection mode to use when connecting the projector and a computer over a wireless LAN. If you select <b>Quick</b> (default), a small network is created automatically by the projector and computer. It is used in combination with EasyMP Network Projection. When the <b>SSID Auto Setting</b> is set to <b>On</b> , the projector becomes an easy access point. When set to <b>Off</b> , the network is created in <u>Ad hoc mode</u> . If you select <b>Advanced</b> , the connection is established in <u>infrastructure mode</u> through the access point installed. When monitoring or controlling the projector over the network, set <b>Advanced</b> . See the following manual for details on connection mode. <ul style="list-style-type: none"> <li> <a href="#">EasyMP Network Projection Operation Guide</a></li> <li> <a href="#">EasyMP Multi PC Projection Operation Guide</a></li> </ul>
Channel	(This can only be set if <b>Connection Mode</b> is set to <b>Quick</b> .) Select the frequency band used by the wireless LAN from <b>1ch</b> , <b>6ch</b> , or <b>11ch</b> . This is set to <b>11ch</b> by default.
SSID Auto Setting	(This can only be set if <b>Connection Mode</b> is set to <b>Quick</b> .) Set to <b>On</b> to speed up the projector search. Set to <b>Off</b> when connecting to multiple projectors at the same time. This is set to <b>On</b> by default.
SSID	(This can only be set if <b>SSID Auto Setting</b> is set to <b>Off</b> .) Enter an <u>SSID</u> . When an SSID is provided for the wireless LAN system in which the projector participates, enter the SSID. You can enter up to 32 single-byte alphanumeric characters (: ^ can only be entered from the Web browser). If the SSID is left blank or set to ANY, an ANY connection (selects a connection from local access points without specifying an SSID) is established.

Submenu	Function
<b>Search Access Point</b>	When Connection Mode is set to <b>Advanced</b> , you can search for surrounding access points, and select the SSID to connect from those access points. Depending on the access point settings, they may not be displayed in the list. You must set security separately.
<b>IP Settings</b>	<p>(This can only be set if <b>Connection Mode</b> is set to <b>Advanced</b>.) You can make network settings.</p> <p><b>DHCP:</b> Set to <b>On</b> to configure the network using <b>DHCP</b>. If this is set to <b>On</b>, you cannot set any more addresses.</p> <p><b>IP Address:</b> You can enter the <b>IP address</b> assigned to the projector. You can enter a number from 0 to 255 in each field of the address. However, the following IP addresses cannot be used. 0.0.0.0, 127.x.x.x, 224.0.0.0 to 255.255.255.255 (where x is a number from 0 to 255)</p> <p><b>Subnet Mask:</b> You can enter the <b>Subnet Mask</b> for the projector. You can enter a number from 0 to 255 in each field of the address. However, the following subnet masks cannot be used. 0.0.0.0, 255.255.255.255</p> <p><b>Gateway Address:</b> You can enter the IP address for the <b>gateway</b> for the projector. You can enter a number from 0 to 255 in each field of the address. However, the following gateway addresses cannot be used. 0.0.0.0, 127.x.x.x, 224.0.0.0 to 255.255.255.255 (where x is a number from 0 to 255)</p>
<b>SSID Display</b>	To prevent the <b>SSID</b> from being displayed on the LAN Standby screen, set this to <b>Off</b> .
<b>IP Address Display</b>	To prevent the <b>IP address</b> from being displayed on the LAN Standby screen, set this to <b>Off</b> .

### Search access point screen

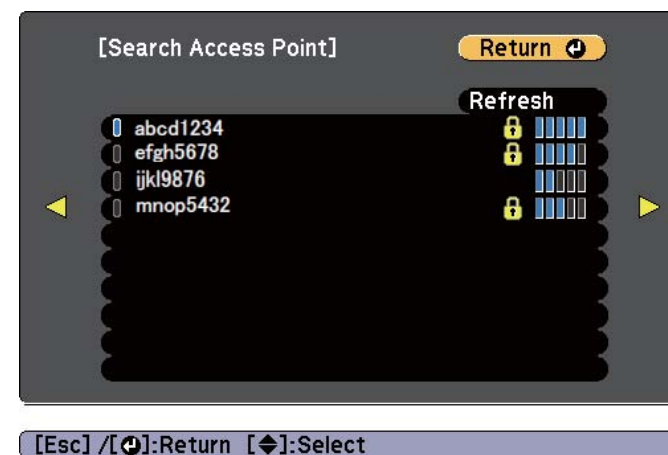
Detected access points are displayed in a list. You can detect up to 30 access points.



Submenu	Function
<b>Refresh</b>	Searches for the access point again.
	Indicates an access point that is being connected.
	<p>Indicates the access points where security is set.</p> <p>If you select an access point where security has not been set, the Wireless LAN menu is displayed.</p> <p>If you select an access point where security has been set, the Security menu is displayed. Select a type of security according to the security settings for the access point.</p>

## Security menu

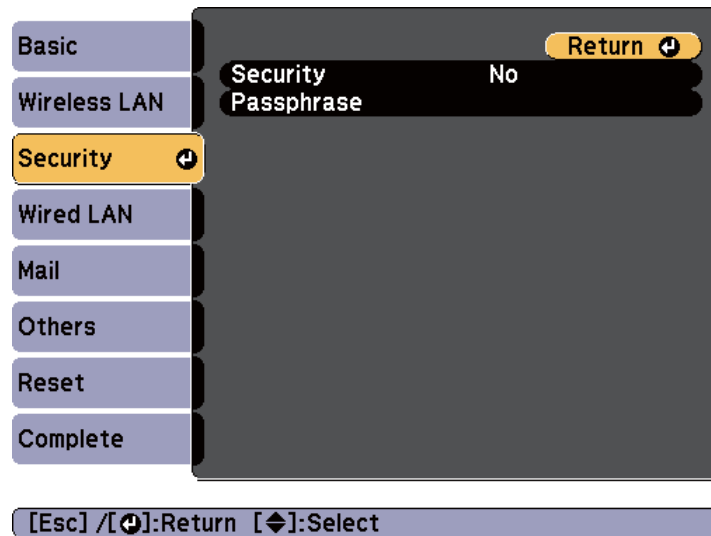

Submenu	Function
Security	Select the security type from the items that are displayed. When setting security, follow the instructions from the administrator of the network system you are about to access.

Submenu	Function
Passphrase	<p>(This can only be selected when <b>Security</b> is set to <b>WPA2-PSK</b> or <b>WPA/WPA2-PSK</b>.)</p> <p>Enter the passphrase. You can enter at least 8 and up to 63 single-byte alphanumeric characters.</p> <p>When using with EasyMP Network Projection, you do not need to enter the passphrase in the computer if it is the initial (default) passphrase.</p> <p>☛ "Reset Menu" p.136</p> <p>You can enter up to 32 characters on the Configuration menu. When entering more than 32 characters, use your Web browser to enter the text.</p> <p>☛ "Changing Settings Using a Web Browser (Web Control)" p.186</p> <p>When <b>Connection Mode</b> is set to <b>Quick</b>, the initial passphrase is set.</p>

## Type of security

When the optional wireless LAN unit is attached and being used in Advanced connection mode, it is strongly recommended that you set security.

WPA is an encryption standard that improves the security for wireless networks. The projector supports TKIP and AES encryption methods.

WPA also includes user authentication functions. WPA authentication provides two methods: using an authentication server, or authenticating between a computer and an access point without using a server. This projector supports the latter method, without a server.



For setting details, follow the instructions from your network administrator.

## Wired LAN menu

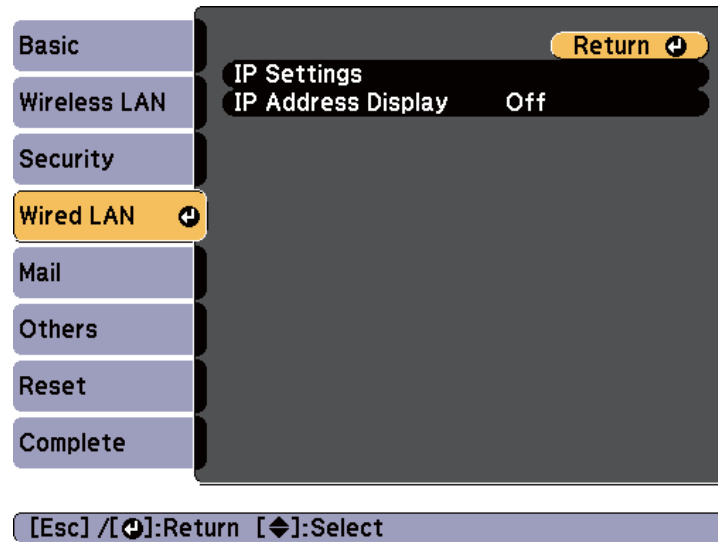

Submenu	Function
IP Settings	<p>You can make settings related to the following addresses.</p> <p><b>DHCP:</b> Set to <b>On</b> to configure the network using <a href="#">DHCP</a>. If this is set to <b>On</b>, you cannot set any more addresses.</p> <p><b>IP Address:</b> You can enter the <a href="#">IP address</a> assigned to the projector. You can enter a number from 0 to 255 in each field of the address. However, the following IP addresses cannot be used. 0.0.0.0, 127.x.x.x, 224.0.0.0 to 255.255.255.255 (where x is a number from 0 to 255)</p> <p><b>Subnet Mask:</b> You can enter the <a href="#">Subnet Mask</a> for the projector. You can enter a number from 0 to 255 in each field of the address. However, the following subnet masks cannot be used. 0.0.0.0, 255.255.255.255</p> <p><b>Gateway Address:</b> You can enter the IP address for the <a href="#">gateway</a> for the projector. You can enter a number from 0 to 255 in each field of the address. However, the following gateway addresses cannot be used. 0.0.0.0, 127.x.x.x, 224.0.0.0 to 255.255.255.255 (where x is a number from 0 to 255)</p>
IP Address Display	<p>To prevent the IP address from being displayed on Network Info in the Network menu and on the LAN Standby screen, set this to <b>Off</b>.</p>

## Mail menu

When this is set, you receive an email notification if a problem or warning occurs in the projector.

☛ "Using the Using Mail Notification to Report Problems" p.187

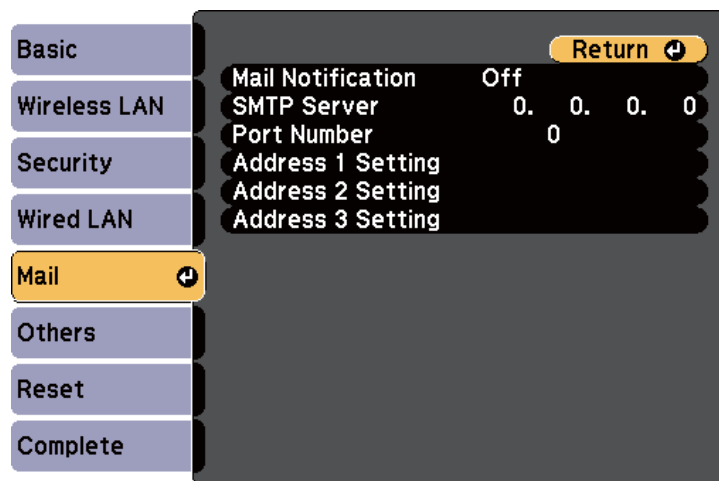

[Esc] / [↵]:Return [◆]:Select

Submenu	Function
<b>Mail Notification</b>	Set to <b>On</b> to send an email to the preset addresses when a problem or warning occurs with a projector.
<b>SMTP Server</b>	You can enter the <u>IP address</u> for the SMTP server for the projector. You can enter a number from 0 to 255 in each field of the address. However, the following IP addresses cannot be used. 127.x.x.x, 224.0.0.0 to 255.255.255.255 (where x is a number from 0 to 255)
<b>Port Number</b>	You can enter the port number for the SMTP server. The default value is 25. You can enter numbers between 0 to 65535.

Submenu	Function
<b>Address 1 Setting/Address 2 Setting/Address 3 Setting</b>	You can enter the email address of the destination to which you want to send the notification email. You can register up to three destinations. You can enter up to 32 single-byte alphanumeric characters for the email address. The following characters cannot be used " ( ) , ; < > [ \ ] The address for destination 1 is the mail notification sender's address. You can select the problems or warnings to be notified about by email. When the selected problem or warning occurs in the projector, an email is sent to the specified email address notifying that a problem or warning has occurred. You can select multiple items from the displayed items.

## Others menu

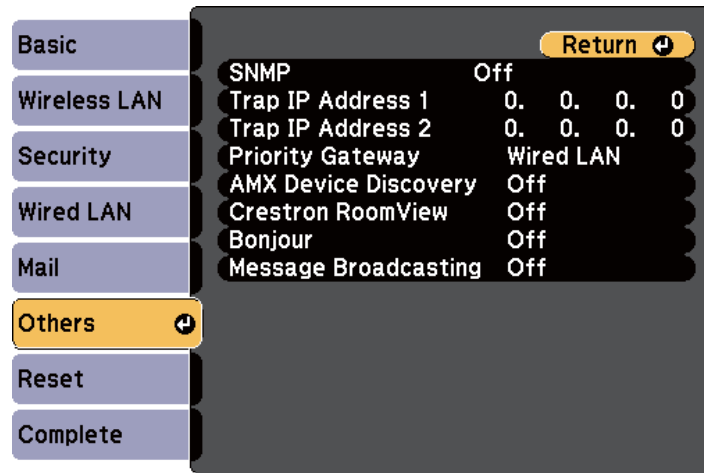

[Esc] / [Return]: Return [Down Arrow]: Select

Submenu	Function
<b>Crestron RoomView</b>	Set this to <b>On</b> only when monitoring or controlling the projector over the network using Crestron RoomView®. Otherwise, set this to <b>Off</b> .  "About Crestron RoomView®" <a href="#">p.193</a> When this is set to <b>On</b> , the following functions are not available. <ul style="list-style-type: none"> <li>• Web Control</li> <li>• Message Broadcasting (EasyMP Monitor Plug-in)</li> </ul>
<b>Bonjour</b>	Set this to <b>On</b> when connecting to the network using Bonjour. See Apple's Web site for more information on the Bonjour service. <a href="http://www.apple.com/">http://www.apple.com/</a>
<b>Message Broadcasting</b>	You can switch the EPSON Message Broadcasting function to enable or disable.

Submenu	Function
<b>SNMP</b>	Set to <b>On</b> to monitor the projector using SNMP. To monitor the projector, you need to install the SNMP manager program on your computer. SNMP should be managed by a network administrator. The default value is <b>Off</b> .
<b>Trap IP Address 1/Trap IP Address 2</b>	You can register up to two IP addresses for the SNMP trap notification destination. You can enter a number from 0 to 255 in each field of the address. However, the following IP addresses cannot be used. 127.x.x.x, 224.0.0.0 to 255.255.255.255 (where x is a number from 0 to 255)
<b>Priority Gateway</b>	You can set the priority gateway to a <b>Wired LAN</b> or <b>Wireless LAN</b> .
<b>AMX Device Discovery</b>	When the projector is connected to a network, set to <b>On</b> to allow the projector to be detected by <a href="#">AMX Device Discovery</a> . Set to <b>Off</b> if you are not connected to an environment controlled by a controller from AMX or AMX Device Discovery.

### Reset Menu

Resets all of the network settings.

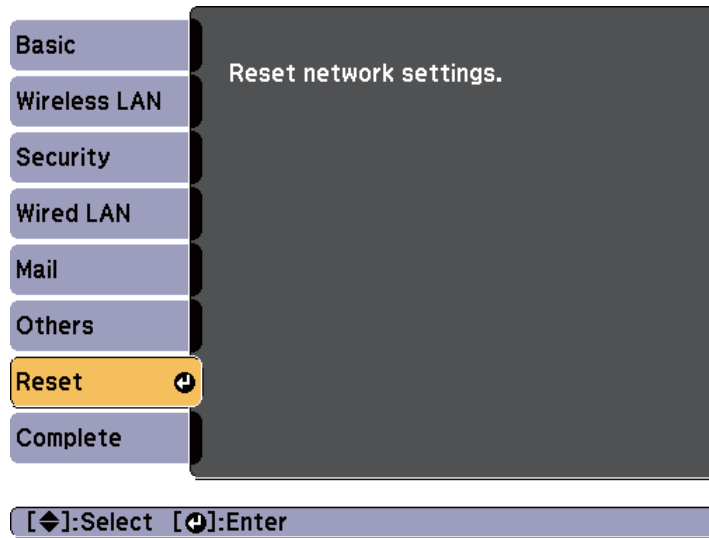

Submenu	Function
Reset network settings.	To reset all of the Network settings, select <b>Yes</b> .

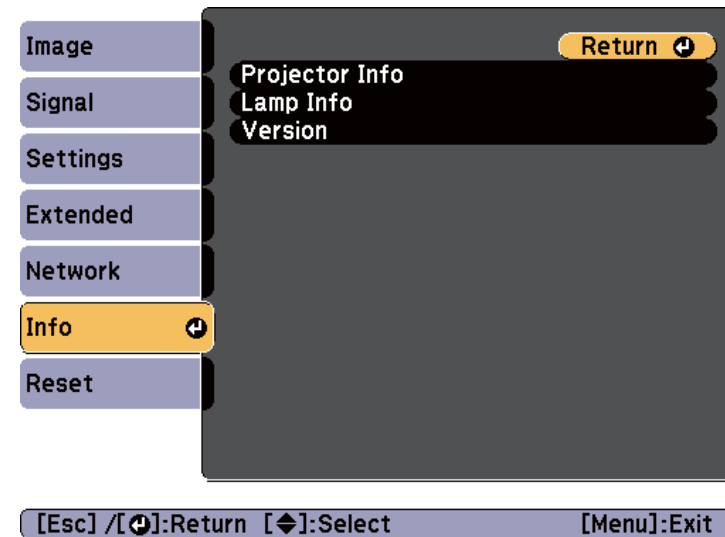

### Info Menu (Display Only)

Lets you check the status of the image signals being projected and the status of the projector. Items that can be displayed vary depending on the source currently being projected.



Submenu	Function	
Projector Info	<b>Source</b>	You can display the source name for the connected equipment currently being projected.
	<b>Input Signal</b>	You can display the content of the <b>Input Signal</b> set in the <b>Signal</b> menu according to the source.
	<b>Resolution</b>	You can display the resolution.
	<b>Video Signal</b>	You can display the settings for <b>Video Signal</b> in the <b>Signal</b> menu.
	<b>Refresh Rate</b>	You can display the <u>refresh rate</u> ▶▶.



Submenu		Function
	<b>Sync Info</b>	You can display the image signal information. This information may be needed if service is required.
	<b>Status</b>	You can display information about errors that have occurred on the projector. This information may be needed if service is required.
	<b>Serial Number</b>	You can display the projector's serial number.
	<b>Event ID</b>	When problems occur when the projector and computer are connected through the network, information on the problem is displayed using an Event ID. See the following page for information on interpreting the Event ID.  "Event ID" <a href="#">p.170</a>
	<b>HDBaseT Signal Quality</b>	You can display the image signal information from the HDBaseT port.
<b>Lamp Info</b>	<b>Lamp Hours</b>	You can display the cumulative lamp operating time*. When the lamp replacement time is reached, the characters are displayed in yellow.
	<b>Lamp Status</b>	The following icons show the status of the lamps.  : On  : Off

Submenu		Function
<b>Version</b>	<b>Main Video Status Monitor</b>	Displays the projector's firmware version information.

\* The cumulative use time is displayed as "0H" for the first 10 hours. 10 hours and above is displayed as "10H", "11H", and so on.

## Reset Menu

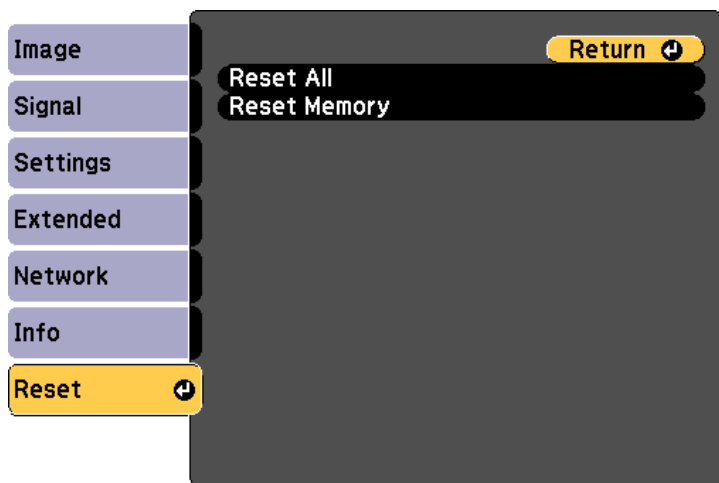

[Esc] / [Return]:Return [Left/Right]:Select [Menu]:Exit

Submenu	Function
<b>Reset All</b>	You can reset all items in the Configuration menu to their default settings. The settings for the <b>Input Signal, Memory, Panel Alignment, Color Uniformity, Date &amp; Time, Color Matching, Lamp Select, Language, Lamp Hours</b> , all items for the <b>Network</b> menu, and password are not returned to their default values.
<b>Reset Memory</b>	Resets the names and settings stored in <b>Save Memory</b> . ☛ "Memory Function" <a href="#">p.98</a>



# Troubleshooting

This chapter explains how to identify problems and what to do if a problem is found.

If a problem occurs with the projector, the Help screen is displayed to assist you by pressing the [Help] button. You can solve problems by answering the questions.

- 1 Press the [Help] button.  
The Help screen is displayed.

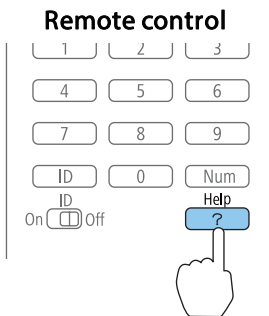

- 2 Select a menu item.

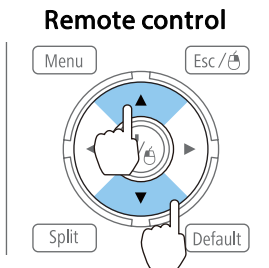
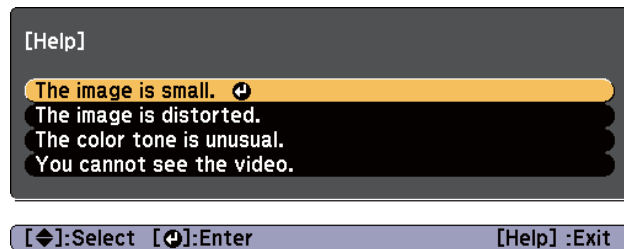

- 3 Confirm the selection.

### Remote control

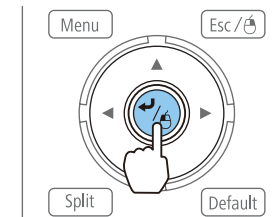

Questions and solutions are displayed as shown on the screen below. Press the [Help] button to exit the Help.

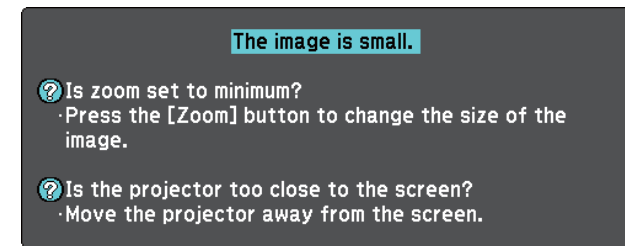

[Esc]:Return [Help]:Exit



See the following if the Help function does not provide a solution to the problem.





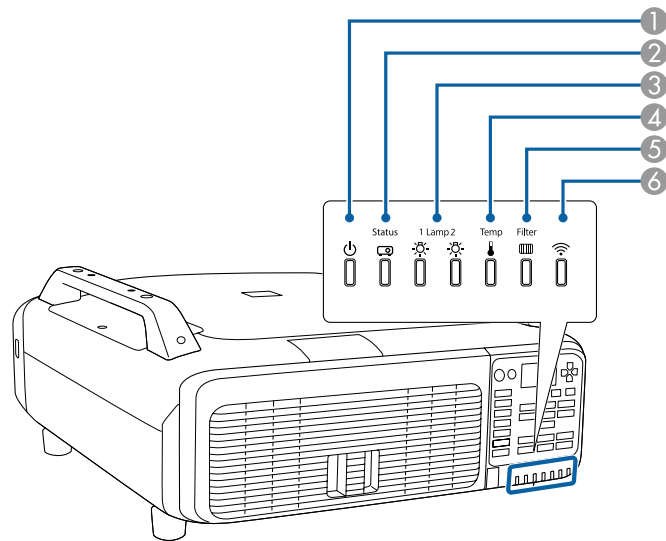

























☛ "Problem Solving" p.160

This projector is provided with the following six indicators. The color and lit status of the indicators show the status of the projector.









- ① Power indicator  
Indicates the projector's status.
- ② Status indicator  
Indicates the projector's status.
- ③ Lamp1/Lamp2 indicators  
Indicates the projection lamps status.
- ④ Temp indicator  
Indicates the internal temperature status. This is normally turned off.
- ⑤ Filter indicator  
Indicates the air filter status. This is normally turned off.
- ⑥ Wireless LAN indicator  
Indicates the operating status of wireless LAN when the optional wireless LAN unit is connected.

















The following indicator status are used during regular operation.

Indicator					Projector's Status	Explanation
Power	Status	Lamp1/ Lamp2	Temp	Filter		
 Blue - On	 Off	 Off	 Off	 Off	Standby condition	Power is being supplied to the projector. In this status, you can start projecting by pressing the [ⓘ] button on the remote control or control panel. (Sometimes, when the power cord is unplugged, the power indicator remains lit for a short period, but this is not a fault.)
					Network monitoring status	The projector is being monitored and controlled over a network (when <b>Standby Mode</b> is set to <b>Communication On</b> ). If the power cord is disconnected and then reconnected in this status, the power indicator flashes blue.
 Blue - On	 Blue - Flashing	 Status varies	 Off	 Off	Warm-up status	This is the status immediately after turning on the projector. Warm-up takes approximately 30 seconds after the lamp turns on. The [ⓘ] button is disabled during warm-up.
 Blue - On	 Blue - On	 Status varies	 Off	 Off	Projecting	The projector is projecting.
 Blue - On	 Blue - Flashing	 Off	 Off	 Off	Cool down status	This is the status immediately after turning off the power. In this status, all buttons are disabled.
 Blue - Flashing	 Off	 Off	 Off	 Off	Preparing Network monitoring	Preparing to monitor and control this projector over a network. During network monitoring preparation, all button operations are disabled.
 Blue - On	 Blue - On	 Blue - Flashing	 Off	 Off	While the shutter function activated	The shutter function is activated.



























When an error has occurred in the projector, the error status is indicated by the indicator's color and combination of flashing or lit.











Refer to the following table to see what the indicators mean and how to remedy problems that they indicate.











Indicator					Cause	Remedy or Status	Status Monitor Display
Power	Status	Lamp1/ Lamp2	Temp	Filter			
Off	Blue - Flashing	Orange - Flashing	Off	Off	Internal Error	Stop using the projector, remove the power cord from the electrical outlet, and contact your local dealer or the nearest address provided in the Epson Projector Contact List.  <a href="#">Epson Projector Contact List</a>	Internal Error
Off	Blue - Flashing	Off	Orange - Flashing	Off	Fan Error Sensor Error	Stop using the projector, remove the power cord from the electrical outlet, and contact your local dealer or the nearest address provided in the Epson Projector Contact List.  <a href="#">Epson Projector Contact List</a>	Fan Error Sensor Error
Off	Blue - Flashing	Off	Orange - On	Off	High Temp Error (Overheating)	The lamp turns off automatically and projection stops. Wait for about five minutes. After about five minutes the projector switches to standby mode, so check the following two points. <ul style="list-style-type: none"> <li>• Check that the air filter and air exhaust vents are clear, and that the projector is not positioned against a wall.</li> <li>• If the air filter are clogged, remove the power cord from the electrical outlet, and then clean or replace them.                             <ul style="list-style-type: none"> <li> "Cleaning the Air Filter" <a href="#">p.172</a></li> <li> "Replacing the Air Filter" <a href="#">p.179</a></li> </ul> </li> </ul> If the error continues after checking the points above, stop using the projector, remove the power cord from the electrical outlet, and contact your local dealer or the nearest address provided in the Epson Projector Contact List.  <a href="#">Epson Projector Contact List</a>	Temp Error
						When using at an altitude of 1,500 m or more, set <b>High Altitude Mode</b> to <b>On</b> .  <b>Extended - Operation - High Altitude Mode</b> <a href="#">p.122</a>	
						Set <b>Direction</b> to <b>Pointing Down</b> , <b>Pointing Up</b> , <b>Angled Up</b> , or <b>Angled Down</b> when the projector is installed in a direction which is not horizontal.  <b>Extended - Direction</b> <a href="#">p.122</a>	





Indicator					Cause	Remedy or Status	Status Monitor Display
Power	Status	Lamp1/ Lamp2	Temp	Filter			
 Off	 Blue - Flashing	 Off	 Orange - Flashing	 Off	Cool System Error	Stop using the projector, remove the power cord from the electrical outlet, and contact your local dealer or the nearest address provided in the Epson Projector Contact List.  <a href="#">Epson Projector Contact List</a>	Pump Error
 Off	 Blue - Flashing	 Orange - On	 Off	 Off	Lamp Error Lamp Failure	Check the following points. <ul style="list-style-type: none"> <li>Remove the lamps and check if they are cracked.   "Replacing the Lamp" <a href="#">p.175</a></li> <li>Clean the air filter.   "Cleaning the Air Filter" <a href="#">p.172</a></li> </ul> <p><b>If the lamps are not cracked:</b> Attach the lamps again and turn on the power.  <b>If the error continues:</b> Replace the lamps with new ones and then turn on the power.</p> <p><b>If the error continues:</b> Stop using the projector, remove the power cord from the electrical outlet, and contact your local dealer or the nearest address provided in the Epson Projector Contact List.   <a href="#">Epson Projector Contact List</a></p> <p><b>If the lamp is cracked:</b> Contact your local dealer or the addresses on the Epson Projector Contact List for further advice. (If one of the lamps cracks, only the other lamp is used. Replace the lamp as soon as you can.)   <a href="#">Epson Projector Contact List</a></p> <p>When using at an altitude of 1,500 m or more, set <b>High Altitude Mode</b> to <b>On</b>.   <b>Extended - Operation - High Altitude Mode</b> <a href="#">p.122</a></p> <p>Set <b>Direction</b> to <b>Pointing Down</b>, <b>Pointing Up</b>, <b>Angled Up</b>, or <b>Angled Down</b> when the projector is installed in a direction which is not horizontal.   <b>Extended - Direction</b> <a href="#">p.122</a></p>	Lamp1 Error (S) Lamp1 Error (P) Lamp2 Error (S) Lamp2 Error (P)
							Lamp1 Failure (S) Lamp1 Failure (P) Lamp2 Failure (S) Lamp2 Failure (P)







Indicator					Cause	Remedy or Status	Status Monitor Display
Power	Status	Lamp1/ Lamp2	Temp	Filter			
 Off	 Blue - Flashing	 Off	 Off	 Orange - On	Filter Airflow Error	<p>Check the following points.</p> <ul style="list-style-type: none"> <li>• Check that the air filter and air exhaust vents are clear, and that the projector is not positioned against a wall.</li> <li>• If the air filter is clogged, turn off the power, remove the power cord from the electrical outlet, and then clean or replace them.</li> </ul> <p> "Cleaning the Air Filter" <a href="#">p.172</a>   "Replacing the Air Filter" <a href="#">p.179</a></p> <p>After checking, connect the power cord to the electrical outlet.</p> <p>If the error continues after checking the points above, stop using the projector, remove the power cord from the electrical outlet, and contact your local dealer or the nearest address provided in the Epson Projector Contact List.</p> <p> <a href="#">Epson Projector Contact List</a></p>	Airflow Error
 Off	 Blue - Flashing	 Orange - Flashing	 Orange - Flashing	 Off	Cinema Filter Error Auto Iris Error Shutter Error	<p>Stop using the projector, remove the power cord from the electrical outlet, and contact your local dealer or the nearest address provided in the Epson Projector Contact List.</p> <p> <a href="#">Epson Projector Contact List</a></p>	CinemaFilterErr. Auto Iris Error Shutter Error
 Off	 Blue - Flashing	 Orange - On	 Orange - On	 Off	Power Err. (Bal- last)	<p>Stop using the projector, remove the power cord from the electrical outlet, and contact your local dealer or the nearest address provided in the Epson Projector Contact List.</p> <p> <a href="#">Epson Projector Contact List</a></p>	Power1 Error Power2 Error
 Blue - Flashing	 Status varies	 Status varies	 Orange - Flashing	 Status varies	High Temp Warn- ing	<p>This is not an error. However, if the temperature rises too high again, projection stops automatically. Check the following points.</p> <ul style="list-style-type: none"> <li>• Check that the air filter and air exhaust vents are clear, and that the projector is not positioned against a wall.</li> <li>• If the air filter is clogged, turn off the power, remove the power cord from the electrical outlet, and then clean or replace them.</li> </ul> <p> "Cleaning the Air Filter" <a href="#">p.172</a>   "Replacing the Air Filter" <a href="#">p.179</a></p>	Temp Warning

Indicator					Cause	Remedy or Status	Status Monitor Display
Power	Status	Lamp1/ Lamp2	Temp	Filter			
 Blue - Flashing	 Status varies	 Orange - Flashing	 Status varies	 Status varies	Replace Lamp	Either Lamp1 or Lamp2 that is indicated by the flashing indicator is due for replacement. Replace it with a new lamp. ☛ "Replacing the Lamp" p.175 If you continue to use the lamp after the replacement period has passed, the possibility that the lamp may explode increases. Replace it with a new lamp as soon as possible. We recommend replacing both lamps together to maintain consistent hue and brightness of projected images.	-
 Status varies	 Status varies	 Orange - Flashing	 Status varies	 Status varies	Mismatching of lamp types warn- ing	The message "Lamp 1 and Lamp 2 do not match. Turn off the projector and install two standard lamps or two portrait mode lamps depending on the orientation of the projector." is displayed. The lamp unit for portrait use is attached to either Lamp 1 or Lamp 2. Turn off the power, remove the power cord from the electrical outlet, and the check the lamp units attached to Lamp 1 and Lamp 2. When performing portrait projection, attach lamp units (for portrait use) on both Lamp 1 and Lamp 2. When performing portrait projection, attach standard lamps on both Lamp 1 and Lamp 2. ☛ "Replacing the Lamp" p.175 The projector automatically turns off about one minute after it detects that the lamps do not match.	Lamp Mismatch

Indicator					Cause	Remedy or Status	Status Monitor Display
Power	Status	Lamp1/ Lamp2	Temp	Filter			
 Blue - Flashing	 Status varies	 Orange - Flashing	 Status varies	 Status varies	Lamp Warning Supply System Warning (Ballast)	<p>Check the following points.</p> <ul style="list-style-type: none"> <li>Remove either Lamp 1 or Lamp 2 that is indicated by the flashing indicator, and check if it is cracked.   "Replacing the Lamp" <a href="#">p.175</a></li> <li>Clean the air filter.   "Cleaning the Air Filter" <a href="#">p.172</a></li> </ul> <p><b>If the lamps are not cracked:</b> Install the lamps again and turn on the power.  <b>If the error continues:</b> Replace the lamps with new ones and then turn on the power.</p> <p><b>If the error continues:</b> Stop using the projector, remove the power cord from the electrical outlet, and contact your local dealer or the nearest address provided in the Epson Projector Contact List.   <a href="#">Epson Projector Contact List</a></p> <p><b>If the lamp is cracked:</b> Contact your local dealer or the addresses on the Epson Projector Contact List for further advice. (If one of the lamps cracks, only the other lamp is used. Replace the cracked lamp as soon as possible.)   <a href="#">Epson Projector Contact List</a></p> <p>When using at an altitude of 1,500 m or more, set <b>High Altitude Mode</b> to <b>On</b>.   <b>Extended - Operation - High Altitude Mode</b> <a href="#">p.122</a></p> <p>Set <b>Direction</b> to <b>Pointing Down, Pointing Up, Angled Up, or Angled Down</b> when the projector is installed in a direction which is not horizontal.   <b>Extended - Direction</b> <a href="#">p.122</a></p>	Lamp1 Warning (S) Lamp1 Warning (P) Lamp2 Warning (S) Lamp2 Warning (P)  Power1 Warning Power2 Warning

Indicator					Cause	Remedy or Status	Status Monitor Display
Power	Status	Lamp1/ Lamp2	Temp	Filter			
 Blue - Flashing	 Status varies	 Status varies	 Status varies	 Orange - On	No Air Filter	The message "Install the air filter." is displayed on the projected screen. Check that the air filter is securely attached. ☛ "Replacing the Air Filter" <a href="#">p.179</a> The projector automatically turns off about one minute after it detects that there is no air filter. If the error continues even though an air filter is attached, the air filter sensor may be defective. Stop using the projector, remove the power cord from the electrical outlet, and contact your local dealer or the nearest address provided in the Epson Projector Contact List. ☛ <a href="#">Epson Projector Contact List</a>	-
					Low Air Flow	This is not an error. However, projection stops automatically if the airflow falls any further. The message "The air filter is clogged. Clean or replace the air filter." is displayed on the projected screen. Check the following points. <ul style="list-style-type: none"> <li>• Check that the air filter and air exhaust vents are clear, and that the projector is not positioned against a wall.</li> <li>• If the air filter is clogged, turn off the power, remove the power cord from the electrical outlet, and then clean or replace them.</li> </ul> ☛ "Cleaning the Air Filter" <a href="#">p.172</a> ☛ "Replacing the Air Filter" <a href="#">p.179</a> If the error continues after checking the points above, stop using the projector, remove the power cord from the electrical outlet, and contact your local dealer or the nearest address provided in the Epson Projector Contact List. ☛ <a href="#">Epson Projector Contact List</a>	Airflow Decline

Indicator					Cause	Remedy or Status	Status Monitor Display
Power	Status	Lamp1/ Lamp2	Temp	Filter			
 Status varies	 Status varies	 Status varies	 Status varies	 Orange - Flashing	Air Filter Notice	<p>The message "Time to clean the air filter. Clean or replace the air filter." is displayed.</p> <p>Turn off the projector's power, unplug the power cord from the electrical outlet, and then clean the air filter.</p> <p>☛ "Cleaning the Air Filter" <a href="#">p.172</a></p> <p>The indicators or messages regarding air filter notice are displayed only when <b>Air Filter Notice</b> is set to <b>On</b> in the Configuration menu.</p> <p>☛ <b>Extended - Display - Air Filter Notice</b> <a href="#">p.122</a></p>	Cleaning Filter



- See the following if the projector is not operating properly, even though the indicators are all showing normal.
  - ☛ "Problem Solving" [p.160](#)
- If the indicators are in a state not shown in this table, stop using the projector, remove the power cord from the electrical outlet, and contact your local dealer or the nearest address provided in the Epson Projector Contact List.
  - ☛ [Epson Projector Contact List](#)

The LCD of the control panel indicates the projector's status. Also, you can check the detailed status or error history of this projector by using the buttons on the control panel.



Make the following settings to use the status monitor when the projector is in standby mode.

- Set **Standby Mode** to **Communication On**.
  - ☛ **Extended - Standby Mode** [p.122](#)
- Set **A/V Output** to **Always On**.
  - ☛ **Extended - A/V Settings - A/V Output** [p.122](#)

You can check the items and information of each category by using the [▲][▼] buttons.

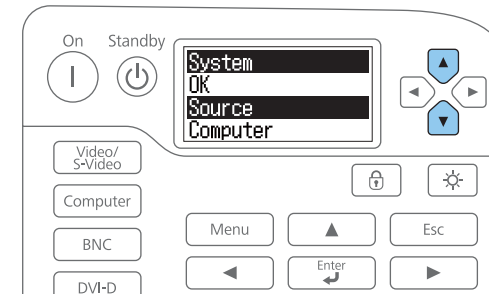

## Checking the Status

To display the status monitor, press the [☼] button on the control panel.

There are eight display categories for the status monitor, and each time you press the [▶][◀] buttons, the category switches in the following order.

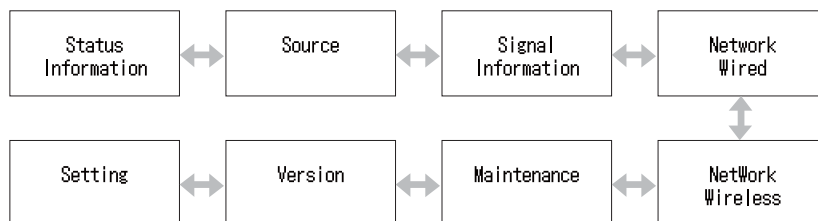
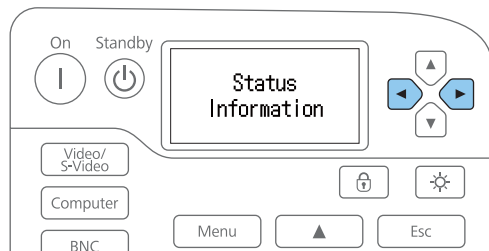

The status monitor turns on in the following situations:

- When one button is pressed on the control panel
- When an error or a warning occurs
- When adjusting the zoom, focus, or lens shift
- When checking the projector ID
  - ☛ "Checking the projector ID" [p.39](#)

If you do not want to turn on the status monitor, set **Lighting Time** to **Off** in the status monitor setting.

- ☛ "Setting the screen display (LCD)" [p.152](#)

## Understanding the screen

### Normal display

Each display category contains the following information.

- Status Information : Operating status of the projector
- Source : Input signal information
- Signal Information : Input digital signal information
- Network Wired : Wired LAN settings
- Network Wireless : Wireless LAN settings
- Maintenance : Operating time for the projector and lamps
- Version : Projector's firmware version

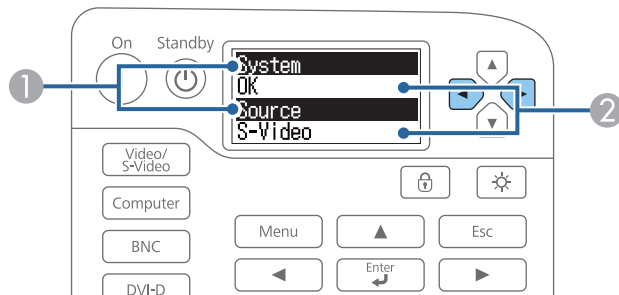

①	Displays the item name. ☛ "Explanations of the Display Content" p.153
②	Information about the items.

Display when error or warning occurs

When a problem has occurred in the projector, the following is displayed.

#### When an error occurs



#### When a warning occurs

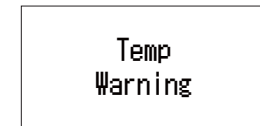

If the problem is cleared, or one of the [⏪][⏩][⏴][⏵] buttons is pressed, the display returns to normal.

See the following for more information on the error or warning contents and remedies.

☛ "Reading the Indicators" p.141

## Setting the screen display (LCD)

You can adjust the contrast and the lighting time for the back light.

- 1 Press the [◀][▶] buttons to select **Setting**.

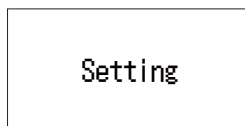

- 2 Press the [⏴] button to display the following screen.



- 3 Press the [◀][▶] buttons to adjust the contrast.

- 4 Press the [⏴] button to display the following screen.



- 5 Press the [◀][▶] buttons to set the lighting time for the back light.

The default is set to **30sec** (30 seconds). You can set from **Off** (light is off), **10-60sec**, and **30min** (30 minutes).



## Explanations of the Display Content

Category	Item	Status Display	Explanation
Status Information	System	Displays the projector's status. See the following for more information on how to remedy the errors and warnings. ☛ "Reading the Indicators" p.141	
		OK	The projector is in normal status.
		Warm-Up	The projector is warming up.
		Standby	The projector is in standby status.
		Cool Down	The projector is in cool down status.
		Temp Error	A high temp error has occurred.
		Fan Error	A fan error has occurred.
		Sensor Error	A sensor error has occurred.
		Lamp1 Error (S)	A lamp error has occurred. (S: Standard lamps, P: Portrait mode lamps)
		Lamp1 Error (P)	
		Lamp2 Error (S)	
		Lamp2 Error (P)	
		Lamp1 Failure (S)	A lamp failure has occurred. (S: Standard lamps, P: Portrait mode lamps)
		Lamp1 Failure (P)	
		Lamp2 Failure (S)	
		Lamp2 Failure (P)	
		Power1 Error	A power error (Ballast) has occurred.
		Power2 Error	
		Internal Error	An internal error has occurred.
		CinemaFilterErr.	A cinema filter error has occurred.
		Auto Iris Error	An auto iris error has occurred.
		Airflow Error	A filter airflow error has occurred.
Shutter Error	A shutter error has occurred.		
Pump Error	A cool system error has occurred.		

Category	Item	Status Display	Explanation	
Status Information	System	Temp Warning	A high temp warning has occurred.	
		Internal Warning	A warning about the internal system has occurred.	
		Airflow Decline	A low air flow error has occurred.	
		Lamp1 Warning (S)	A lamp warning has occurred. (S: Standard lamps, P: Portrait mode lamps) Perform the same remedies as when the lamp error has occurred.	
		Lamp1 Warning (P)		
		Lamp2 Warning (S)		
		Lamp2 Warning (P)		
		Power1 Warning		A power warning (Ballast) has occurred.
		Power2 Warning		
		Shutter Warning	A shutter warning has occurred. Perform the same remedies as when the shutter error has occurred.	
		DirectionWarning	The usage angle is out of range. Check the lamp type, and set it at the correct angle.	
		Lamp Mismatch	A lamp types mismatch has occurred.	
		Clean Filter	An air filter notice has occurred.	
	Source	Computer	Displays the source name for the connected equipment currently being projected.	
		BNC		
		Video		
		S-Video		
		HDMI		
		DVI-D		
		SDI		
		LAN		
		HDBaseT		
	On-ScreenDisplay	On	Displays the settings for the <b>On-Screen Display</b> . When set to <b>Off</b> , the menus or messages are not displayed on the projected images.	
Off				
Shutter	Open	Displays the projector's shutter function status.		
	Close			

Category	Item	Status Display	Explanation
Status Information	Air Temp	-	Displays the usage environment temperature.
	AC Voltage	-	Displays the power voltage.
	Lamp1 Type	Standard	Displays the lamp type attached to Lamp 1. (Standard: Standard lamp, Portrait: Portrait mode lamp)
		Portrait	
	Lamp2 Type	Standard	Displays the lamp type attached to Lamp 2. (Standard: Standard lamp, Portrait: Portrait mode lamp)
		Portrait	
	Lamp1 Status	On	Displays the operating status of Lamp 1.
		Off	
	Lamp2 Status	On	Displays the operating status of Lamp 2.
		Off	
Lamp Select	Dual	Displays the settings for <b>Lamp Select</b> . ☛ "Selecting the lamp" <a href="#">p.31</a>	
	Single		
	Lamp1		
	Lamp2		
Source	Source	Computer	Displays the source name for the connected equipment currently being projected.
		BNC	
		Video	
		S-Video	
		HDMI	
		DVI-D	
		SDI	
		LAN	
		HDBaseT	
	Resolution	-	Displays the resolution of the current input signal. No Signal: No signals are being input. Not Supported: The projector does not support the current input signal.
Video Signal	-	Displays the current input video signal.	

Category	Item	Status Display	Explanation
Source	Color Space	RGB	Displays the color space of the current input signal.
		YCbCr	
		YPbPr	
	H-Frequency	-	Displays the horizontal frequency of the current input signal.
	V-Frequency	-	Displays the vertical frequency of the current input signal.
	Sync Polarity	H:Posi / V:Posi	Displays the Sync polarity.
		H:Posi / V:Nega	
		H:Nega / V:Posi	
		H:Nega / V:Nega	
	Sync Mode	Composite Sync	Displays the sync type.
		Separate Sync	
		Sync On Green	
	Detected Mode	-	Displays the discriminant resolution of the current input signal.
	Video Level	Auto (Normal)	Displays the video level of the projector.
Auto (Expanded)			
Normal			
Expanded			



Items displayed for source vary depending on the model being used and the image signal and source being projected.

Category	Item	Status Display	Explanation
Signal Information	5V Detection	Detected	Displays the detection results of 5V signals.
		Not Detect	
	TMDS Clock	-	Displays the TMDS frequency of the current input signal.
	TMDS H-Frequency	-	Displays the horizontal frequency of the current input signal.
	TMDS V-Frequency	-	Displays the vertical frequency of the current input signal.
	DetChg 5CFHMP123	-	Displays the factors of signal changes.
	Stable Time	-	Displays the operating time since the input source is determined.
	HDCP Status	Non-HDCP	Displays the HDCP status.
		Passed	
		Failed	
	HDCP Ri	-	Displays each HDCP information.
	HDCP AKSV	-	
	HDCP An	-	
	AVI Info VIC	-	Displays the VIC information (AVI) of the current input signal.
	AVI InfoChecksum	OK	Displays the checksum result for AVI.
		NG	
	Signal Mode	HDMI	Displays the signal mode.
		DVI	
	Pixel Encoding	RGB	Displays the color space information (AVI) of the current input signal.
YUV4:4:4			
YUV4:2:2			
YUV4:2:0			
HDBaseT Quality	-	You can display the image signal information from the HDBaseT port.	



Items displayed for Signal Information vary depending on the model being used and the image signal and source being projected.

Category	Item	Status Display	Explanation
Network Wired	Projector Name	-	Displays the projector name used to identify the projector when connected to a network.
	Connection Mode	HDBaseT	Displays the connection path for LAN.
		LAN	
	DHCP	On	Displays the HDCP settings.
		Off	
	IP Display	On	Displays the IP address display settings.
		Off	
IP Address	-	Displays the IP address.	
MAC Address	-	Displays the MAC address.	
Network Wireless	Projector Name	-	Displays the projector name used to identify the projector when connected to a network.
	Connection Mode	Quick	Displays the connection mode to use when connecting the projector and a computer over a wireless LAN.
		Advanced	
	SSID Display	On	Displays the SSID display settings.
		Off	
	IP Display	On	Displays the IP address display settings.
		Off	
	SSID	-	Displays the SSID.
	IP Address	-	Displays the IP address.
	DHCP	On	Displays the HDCP settings.
		Off	
	MAC Address	-	Displays the MAC address.
	Security	No	Displays the security settings.
WPA2-PSK			
WPA/WPA2-PSK			
Antenna Level	LEVEL 0-5	Displays the reception status for Wi-Fi.	



Category	Item	Status Display	Explanation
Maintenance	Operation Time	-	Displays the total operation time of the projector.
	Lamp1 Op.Time	-	Displays the total operation time of the standard lamp.
	Lamp2 Op.Time	-	
	Lamp1 Op.Time PR	-	Displays the total operation time of the portrait mode lamps.
	Lamp2 Pp.Time PR	-	
Version	Serial No.	-	Displays the projector's serial number.
	Main	-	Displays the projector's firmware version information.
	Video	-	
	Status Monitor	-	
Setting	CONTRAST	LEVEL	Set the contrast for the LCD.
	Lighting Time	Off	Set the lighting time for the back light.
		10-60 sec	
		Approx. 30 min	

## Problems Relating to Images

### No images appear

Check	Remedy
Did you press the [ⓘ] button on the remote control or control panel?	Press the [ⓘ] button to turn on the power.
Are the indicators switched off?	The power cord is not connected correctly or power is not being supplied. Connect the projector's power cord correctly. Check that your electrical outlet or power source is functioning correctly.
Is the shutter function active?	Press the [Shutter] button on the remote control to release the shutter function. ☛ "Hiding the Image Temporarily (Shutter)" <a href="#">p.94</a>
Are the Configuration menu settings correct?	Reset all of the settings. ☛ <a href="#">Reset - Reset All p.136</a>
Is the image to be projected completely black? (Only when projecting computer images)	Some input images, such as screen savers, may be completely black.
Is the image signal format setting correct? (Only when projecting images from a video source)	Change the setting according to the signal for the connected equipment. ☛ <a href="#">Signal - Video Signal p.119</a>

### Moving images are not displayed

Check	Remedy
Is the computer's image signal being output to the LCD and the monitor? (Only when projecting images from a laptop computer or a computer with a built-in LCD screen)	Change the image signal from the computer to external output only. Check your computer's documentation, or contact the computer's manufacturer.
Are the contents of the moving image you are trying to project copyright protected?	The projector may not be able to project copyright protected moving images that are being played back on a computer. For more details, see the user's guide supplied with the player.



## Projection stops automatically

Check	Remedy
Is <b>Sleep Mode</b> set to <b>On</b> ?	Press the [ <b>1</b> ] button to turn on the power. If you do not want to use Sleep Mode, change the setting to <b>Off</b> . ☛ <b>Extended - Operation - Sleep Mode</b> <a href="#">p.122</a>

## "Not supported." is displayed

Check	Remedy
Is the image signal format setting correct? (Only when projecting images from a video source)	Change the setting according to the signal for the connected equipment. ☛ <b>Signal - Video Signal</b> <a href="#">p.119</a>
Do the image signal resolution and the refresh rate match the mode? (Only when projecting computer images)	Refer to the computer's documentation for information on how to change the image signal resolution and the refresh rate output from the computer. ☛ "Supported Monitor Displays" <a href="#">p.218</a>

## "No Signal." is displayed

Check	Remedy
Are the cables connected correctly?	Check that all the cables required for projection are securely connected. Check that no cables are disconnected and that there are no poor contacts in the cables.
Is the correct port selected?	Change the image by pressing the [Search] button on the remote control. ☛ "Automatically Detect Input Signals and Change the Projected Image (Search)" <a href="#">p.58</a>
Is the power for the computer or video source turned on?	Turn the power on for the equipment.
Are the image signals being output to the projector? (Only when projecting images from a laptop computer or a computer with a built-in LCD screen)	If the image signals are only being output to the computer's LCD monitor or to the accessory monitor, you need to change the output to an external destination as well as the computer's own monitor. For some computer models, when the image signals are output externally, they no longer appear on the LCD monitor or accessory monitor. If the connection is made while the power of the projector or computer is already turned on, the Fn key (function key) that changes the computer's image signal to external output may not work. Turn the power for the computer and the projector off and then back on again. ☛ Computer's documentation

## Images are fuzzy, out of focus, or distorted

Check	Remedy
Is the focus adjusted correctly?	Make sure that at least 20 minutes has passed after the projection starts, and press the [Focus] button on the remote control to adjust the focus. ☛ "Adjusting the Focus" <a href="#">p.37</a>
Is the projector at the correct distance?	Is it projecting outside of the recommended projection distance range? Setup within the recommended range. ☛ "Screen Size and Projection Distance" <a href="#">p.200</a>
Has condensation formed on the lens?	If the projector is suddenly taken from a cold environment to a warm environment, or if sudden ambient temperature changes occur, condensation may form on the surface of the lens, and this may cause the images to appear fuzzy. Set the projector up in the room about one hour before it is used. If condensation forms on the lens, turn the projector off and wait for the condensation to disappear.
Are you using the optional short throw zoom lens (ELPLU02)?	Set the <b>Lens Type</b> to <b>ELPLU02</b> in the <b>Extended</b> menu. ☛ <b>Extended - Operation - Advanced - Lens Type</b> <a href="#">p.122</a> See the following for more information on focus correction methods. ☛ "When using a short throw zoom lens ELPLU02" <a href="#">p.38</a>

## Interference or distortion appear in images

Check	Remedy
Is the image signal format setting correct? (Only when projecting images from a video source)	Change the setting according to the signal for the connected equipment. ☛ <b>Signal - Video Signal</b> <a href="#">p.119</a>
Are the cables connected correctly?	Check that all the cables required for projection are securely connected. ☛ "Connecting Equipment" <a href="#">p.41</a>
Is an extension cable being used?	If an extension cable is used, electrical interference may affect the signals. Use the cables supplied with the projector to check if the cables you are using may be causing the problem.
Is the correct resolution selected? (Only when projecting computer images)	Set the computer so that the signals being output are compatible with the projector. ☛ "Supported Monitor Displays" <a href="#">p.218</a> ☛ Computer's documentation

Check	Remedy
Are the <b>Sync.</b> and <b>Tracking</b> settings adjusted correctly? (Only when projecting computer images)	Press the [Auto] button to perform automatic adjustment. If the images are not adjusted correctly even after performing automatic adjustment, you can also make adjustments using <b>Sync.</b> or <b>Tracking</b> in the <b>Signal</b> menu. ☛ <b>Signal - Sync., Tracking p.119</b>
Is <b>Auto Setup</b> set to <b>On</b> ? (Only when projecting computer images)	Depending on the input signal, images may be misaligned according to auto setup. If this happens, set <b>Auto Setup</b> to <b>Off</b> . ☛ <b>Signal - Auto Setup p.119</b> When <b>Auto Setup</b> is set to <b>Off</b> , the signals are stored once they are connected. Set <b>Auto Setup</b> to <b>On</b> or <b>Off</b> every time you input a new image signal.
Is the <b>Resolution</b> set to anything other than <b>Auto</b> ? (Only when projecting on a split screen)	The image may be collapsed if the <b>Resolution</b> on the Extended menu and the resolution of the projected image are not the same. If the image is collapsed, set the <b>Resolution</b> to <b>Auto</b> . ☛ <b>Signal - Resolution p.119</b>

## The image is truncated (large) or small, the aspect is not suitable, or the image has been reversed

Check	Remedy
Is the <b>Screen</b> setting correct?	Make the appropriate <b>Screen</b> setting for the screen being used. ☛ "Screen Settings" p.32
Is the aspect adjusted correctly?	Press the [Aspect] button on the remote control to select an aspect suitable for the input source. ☛ "Changing the Aspect Ratio of the Projected Image" p.72
Is the image still being enlarged by E-Zoom?	Press the [Esc] button on the remote control to cancel E-Zoom. ☛ "Enlarging Part of the Image (E-Zoom)" p.95
Is <b>Scale</b> set to <b>On</b> ?	Set <b>Scale</b> to <b>Off</b> in the <b>Signal</b> menu. ☛ <b>Signal - Scale p.119</b>
Is the image position adjusted correctly?	(Only when projecting analog RGB signals input from the Computer input port or the BNC input port) Press the [Auto] button to adjust the display position. You can also adjust the position in the <b>Signal</b> menu. ☛ <b>Signal - Position p.119</b>
Is the computer set for dual display? (Only when projecting computer images)	If dual display is activated in the <b>Display Properties</b> of the computer's Control Panel, only about half of the image on the computer screen is projected. To display the entire image on the computer screen, turn off the dual display setting. ☛ Computer video driver documentation

Check	Remedy
Is the correct resolution selected? (Only when projecting computer images)	Set the computer so that the signals being output are compatible with the projector. <ul style="list-style-type: none"> <li>☛ "Supported Monitor Displays" <a href="#">p.218</a></li> <li>☛ Computer's documentation</li> </ul>
Is the image direction correct?	Make the correct <b>Projection</b> settings in the <b>Extended</b> menu. <ul style="list-style-type: none"> <li>☛ "Installation Settings" <a href="#">p.30</a></li> </ul>

## Image colors are not correct

Check	Remedy
Do the input signal settings match the signals from the connected device?	Change the following settings according to the signal for the connected equipment. <ul style="list-style-type: none"> <li>• When the image is from a device connected to the Computer input port or the BNC input port                             <ul style="list-style-type: none"> <li>☛ <b>Signal - Input Signal</b> <a href="#">p.119</a></li> </ul> </li> <li>• When the image is from a device connected to the Video input port or the S-Video input port                             <ul style="list-style-type: none"> <li>☛ <b>Signal - Video Signal</b> <a href="#">p.119</a></li> </ul> </li> </ul>
Is the image brightness adjusted correctly?	Adjust the <b>Brightness</b> setting in the <b>Image</b> menu. <ul style="list-style-type: none"> <li>☛ <b>Image - Brightness</b> <a href="#">p.117</a></li> </ul>
Are the cables connected correctly?	Check that all the cables required for projection are securely connected. Check that no cables are disconnected and that there are no poor contacts in the cables. <ul style="list-style-type: none"> <li>☛ "Connecting Equipment" <a href="#">p.41</a></li> </ul>
Is the <u>contrast</u>  adjusted correctly?	Adjust the <b>Contrast</b> setting in the <b>Image</b> menu. <ul style="list-style-type: none"> <li>☛ <b>Image - Contrast</b> <a href="#">p.117</a></li> </ul>
Is the color adjustment set correctly?	Adjust the <b>Gamma</b> , <b>RGB</b> , or <b>RGBCMY</b> setting in the <b>Image</b> menu. <ul style="list-style-type: none"> <li>☛ <b>Image - Advanced</b> <a href="#">p.117</a></li> <li>☛ "Adjusting the Image" <a href="#">p.76</a></li> </ul>
Are the color saturation and tint adjusted correctly? (Only when projecting images from a video source)	Adjust the <b>Color Saturation</b> and <b>Tint</b> settings in the <b>Image</b> menu. <ul style="list-style-type: none"> <li>☛ <b>Image - Color Saturation, Tint</b> <a href="#">p.117</a></li> </ul>

## Images appear dark

Check	Remedy
Is the image brightness set correctly?	Check the <b>Brightness</b> in the <b>Image</b> menu and <b>Power Consumption</b> settings in the Settings menu. ☛ <b>Image - Brightness</b> <a href="#">p.117</a> ☛ <b>Settings - Power Consumption</b> <a href="#">p.121</a>
Is the <u>contrast</u>  adjusted correctly?	Adjust the <b>Contrast</b> setting in the <b>Image</b> menu. ☛ <b>Image - Contrast</b> <a href="#">p.117</a>
Is it time to replace the lamp?	When the lamp is nearly ready for replacement, the images become darker and the color quality declines. When this happens, replace the lamp with a new lamp. ☛ "Replacing the Lamp" <a href="#">p.175</a>
Is only one projector being used?	Check if the following items are set to dark. ☛ <b>Extended - Multi-Projection - Brightness Level</b> <a href="#">p.122</a> ☛ <b>Extended - Multi-Projection - Color Matching</b> <a href="#">p.122</a>

## Problems when Projection Starts

### The projector does not turn on

Check	Remedy
Did you press the [Ⓜ] button?	Press the [Ⓜ] button to turn on the power.
Do the indicators turn on and off when the power cord is touched?	There is probably a poor contact in the power cord, or the power cord may be defective. Reinsert the power cord. If this does not solve the problem, stop using the projector, disconnect the power cord from the electrical outlet, and contact your local dealer or the nearest address provided in the Epson Projector Contact List. <a href="#">☛ Epson Projector Contact List</a>
Is the <b>Control Panel Lock</b> set to <b>Full Lock</b> ?	Press the [Ⓜ] button on the remote control. If you do not want to use <b>Control Panel Lock</b> , change the setting to <b>Off</b> . <a href="#">☛ "Control Panel Lock" p.110</a>
Is the correct setting for the remote receiver selected?	Check the <b>remote receiver</b> in the Configuration menu. <a href="#">☛ Settings - Remote Receiver p.121</a>
Was the power cord plugged back in or was the breaker turned on immediately after direct power off?	When one of the operations to the left is performed when <b>Direct Power On</b> is set to <b>On</b> , the power may not turn back on. Press the [Ⓜ] button on the remote control or the control panel to turn on the projector.
Is the [ID] switch on the remote control set to On?	When the switch is set to On, you can use the remote control to operate only a projector with a matching ID. Set the [ID] switch to Off. <a href="#">☛ "Setting the remote control ID" p.40</a>
Are the lamp cover and lamps attached correctly?	If the lamp or lamp cover is not attached correctly, the projector cannot be turned on. Check that they are attached correctly. <a href="#">☛ "How to replace the lamp" p.176</a>

## Other Problems

### The remote control does not turn on

Check	Remedy
Is the remote control light-emitting area pointing towards the remote receiver on the projector during operation?	Point the remote control towards the remote receiver. ☛ "Remote control operating range" <a href="#">p.24</a>
Is the remote control too far from the projector?	The operating range for the remote control is about 30 m. ☛ "Remote control operating range" <a href="#">p.24</a>
Is direct sunlight or strong light from fluorescent lamps shining onto the remote receiver?	Set the projector up in a location where strong light does not shine onto the remote receiver.
Is the correct setting for the <b>remote receiver</b> selected?	Check the <b>remote receiver</b> in the Configuration menu. ☛ <a href="#">Settings - Remote Receiver p.121</a>
Are the batteries dead or have the batteries been inserted incorrectly?	Make sure the batteries are inserted correctly or replace the batteries with new ones if necessary. ☛ "Replacing the remote control batteries" <a href="#">p.23</a>
Do the remote control ID and the projector ID match?	Make sure the ID for the projector you want to operate and the ID for the remote control match. To operate all projectors by remote control regardless of the ID setting, set the [ID] switch on the remote control to Off. ☛ "ID Settings" <a href="#">p.39</a>
Does the <b>Remote Control Type</b> match the remote control that you are using?	Check the <b>Remote Control Type</b> on the Configuration menu. ☛ <a href="#">Extended - Operation - Advanced - Remote Control Type p.122</a>
Is the optional remote control cable connected to the projector's Remote port?	When the remote control cable is connected, the projector's remote receiver is disabled. When not using the remote control cable set, disconnect it from the Remote port.
Is <b>Control Communications</b> set to <b>On</b> ?	The Remote port is disabled. When using the optional remote control cable set, set <b>Control Communications</b> to <b>Off</b> . ☛ <a href="#">Extended - HDBaseT - Control Communications p.122</a>
Is the remote control button lock set?	When the remote control button lock is set, buttons except for those needed for basic remote control operations are deactivated. Hold down the [Help] button to cancel the remote control button lock. ☛ "Remote Control Button Lock" <a href="#">p.111</a>

## Nothing appears on the external monitor

Check	Remedy
Are images being input from a port other than the Computer input port or BNC input port?	Only RGB signals from the Computer input port or the BNC input port can be displayed on an external monitor.
Are you projecting a split screen?	Only RGB signals projected on the left screen from the Computer input port or the BNC input port can be displayed on an external monitor. ☛ "Projecting Two Images Simultaneously (Split Screen)" <a href="#">p.91</a>
Is the projector in standby status?	Check that <b>Standby Mode</b> , <b>A/V Output</b> , and <b>Monitor Out</b> in the Configuration menu are set correctly. ☛ <b>Extended - Standby Mode</b> <a href="#">p.122</a> ☛ <b>Extended - A/V Settings - A/V Output</b> <a href="#">p.122</a> ☛ <b>Extended - A/V Output - Monitor Out</b> <a href="#">p.122</a>

## I want to change the language for messages and menus

Check	Remedy
Change the language setting.	Select the <b>Language</b> in the Extended menu. ☛ <b>Extended - Language</b> <a href="#">p.122</a>

## Email is not received even if a problem occurs in the projector

Check	Remedy
Is <b>Standby Mode</b> set to <b>Communication On</b> ?	To use the mail notification function when the projector is in standby, set <b>Communication On</b> in <b>Standby Mode</b> in the Configuration menu. ☛ <b>Extended - Standby Mode</b> <a href="#">p.122</a>
Did a fatal error occur and the projector come to a sudden stop?	When the projector comes to a sudden stop, email cannot be sent. If the error state continues, contact your local dealer or the nearest address provided in the Epson Projector Contact List. ☛ <a href="#">Epson Projector Contact List</a>
Is power being supplied to the projector?	Check that your electrical outlet or power source is functioning correctly.
Is the mail notification function set correctly in the Network menu?	An error notification email is sent according to the <b>Mail</b> settings in the Network menu. Check if it is set correctly. ☛ <b>Network - Mail</b> <a href="#">p.134</a>



## "The battery that saves your clock settings is running low." is displayed



Check	Remedy
The internal power supply that saves your clock settings is running low.	Contact your local dealer or the nearest address provided in the Epson Projector Contact List.  <a href="#">Epson Projector Contact List</a>

## Cannot change settings using a Web browser

Check	Remedy
Are the user ID and password correct?	Enter "EPSONWEB" as the user ID. This cannot be changed. Enter the user ID even if the password setting is disabled. Enter the characters set for the Web Control Password as the password. The default password is "admin".

Check the numbers and then apply the following countermeasures. If you cannot resolve the problem, contact your network administrator, or contact your local dealer or the nearest address provided in the Epson Projector Contact List.

 [Epson Projector Contact List](#)

Event ID	Cause	Remedy
0432 0435	Failed to startup EasyMP Network Projection.	Restart the projector.
0434 0482 0484 0485	Network communication is unstable.	Check the network communication status, and reconnect after waiting for a while.
0433	Cannot play transferred images.	Restart EasyMP Network Projection.
0481	Communication was disconnected from the computer.	
0483 04FE	EasyMP Network Projection ended unexpectedly.	Check the status of network communications. Restart the projector.
0479 04FF	A system error occurred in the projector.	Restart the projector.
0891	Cannot find an access point with the same SSID.	Set the computer, the access point, and the projector to the same SSID.
0892	The WPA/WPA2 authentication type does not match.	Check that the wireless LAN security settings are correct.
0893	The TKIP/AES encryption types do not match.	 <a href="#">Network - Security p.132</a>
0894	Communication was disconnected because the projector connected to an unauthorized access point.	Contact your network administrator for more information.
0898	Failed to acquire DHCP.	Check that the DHCP server is operating correctly. If you are not using DHCP, turn off the DHCP setting.  <a href="#">Network - Wireless LAN p.130</a> , <a href="#">Wired LAN p.133</a>
0899	Other communication errors	If restarting the projector or EasyMP Network Projection does not solve the problem, contact your local dealer or the nearest address provided in the Epson Projector Contact List.  <a href="#">Epson Projector Contact List</a>



# Maintenance

This chapter provides information on maintenance procedures to ensure the best level of performance from the projector for a long time to come.

You should clean the projector if it becomes dirty or if the quality of projected images starts to deteriorate.



## Caution

When cleaning, unplug the power cord from the electrical outlet. Otherwise, it could cause an electric shock.

---

## Cleaning the Projector's Surface

Clean the projector's surface by wiping it gently with a soft cloth.

If the projector is particularly dirty, moisten the cloth with water containing a small amount of neutral detergent, and then firmly wring the cloth dry before using it to wipe the projector's surface.

### Attention

Do not use volatile substances such as wax, alcohol, or thinner to clean the projector's surface. The quality of the case may change or become discolored.

---

## Cleaning the Lens

Use a commercially available cloth for cleaning glasses to gently wipe the lens.



## Warning

Do not use sprays that contain flammable gas to remove dust and lint from the lens. The projector may catch fire due to the high internal temperature of the lamp.

### Attention

Do not rub the lens with harsh materials or subject the lens to shocks, as it can easily become damaged.

---

## Cleaning the Air Filter

Clean the air filter and the air intake vent when the following message is displayed or the Filter indicator is flashing green.

☛ "Reading the Indicators" p.141

"Time to clean the air filter. Clean or replace the air filter."

"Make sure nothing is blocking the air vent, and clean or replace the air filter."

"The air filter is clogged. Clean or replace the air filter."

### Attention

- If dust collects on the air filter, it can cause the internal temperature of the projector to rise, and this can lead to problems with operation and shorten the optical engine's service life. Clean the air filter immediately when the message is displayed.
- Do not rinse the air filter in water. Do not use detergents or solvents.
- When using a brush for cleaning, use one with long soft bristles, and brush it lightly. If it is brushed too strongly, dust will be ground into the air filter and cannot be removed.



If a message is frequently displayed, even after cleaning, it is time to replace the air filter. Replace it with a new air filter.

☛ "How to replace the air filter" [p.179](#)

- It is recommended that you clean the air filter at least once every three months. Clean it more often than this if using the projector in a particularly dusty environment.
- The indicators or messages regarding air filter notice are displayed only when **Air Filter Notice** is set to **On** in the Configuration menu.

☛ **Extended - Display - Air Filter Notice** [p.122](#)

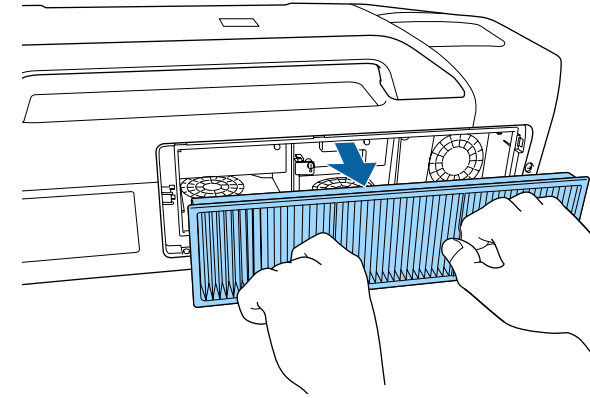

**1** After you turn off the projector's power and the confirmation buzzer beeps twice, disconnect the power cord.

**2** Remove the air filter cover.

Grip the air filter cover tab between your fingers, and pull up and remove the cover while pressing the tab.

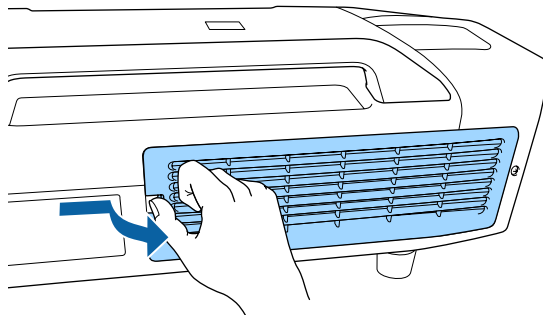

**3** Remove the air filter.

**4** With the front (the side with tabs) of the air filter facing down, tap the air filter four or five times to shake off the dust. Turn it over and tap the other side in the same way.

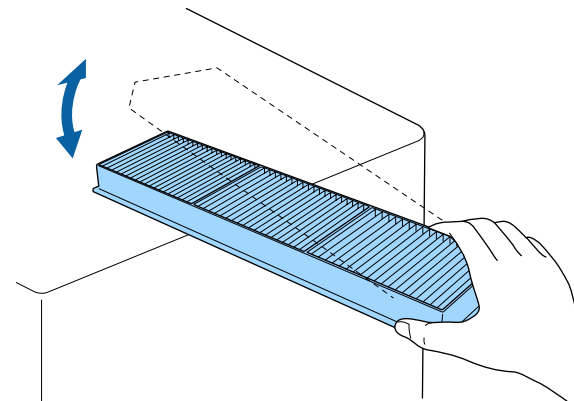

### Attention

If the air filter is hit too hard, it may become unusable due to deformities and cracks.

- 5** Remove any dust remaining on the air filter by using a vacuum cleaner from the front.

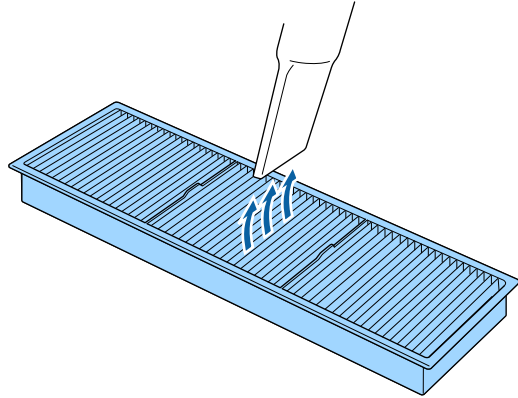

- 6** Attach the air filter.

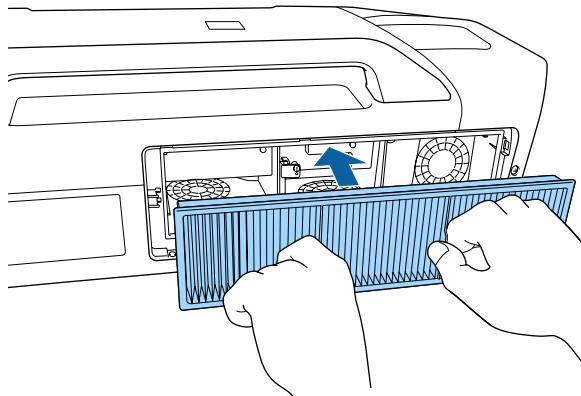

- 7** Attach the air filter cover.  
Press the air filter cover until it clicks into place.

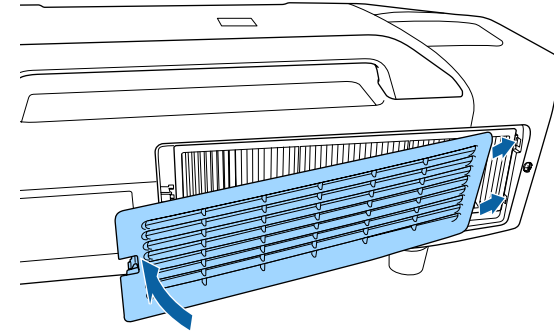

This section explains how to replace the lamp and the air filter.

## Replacing the Lamp

### Lamp replacement period

It is time to replace the lamp when:

- The following message is displayed.  
"It is time to replace your lamp. Please contact your Epson projector reseller or visit [www.epson.com](http://www.epson.com) to purchase."

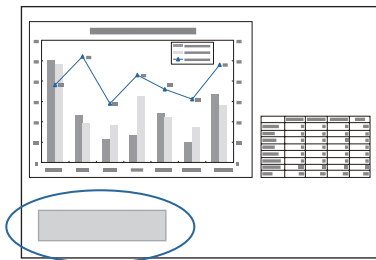

The message is displayed for 30 seconds.

- The power indicator is flashing blue, and the Lamp1 or Lamp2 indicator is flashing orange.  
☛ "Reading the Indicators" [p.141](#)

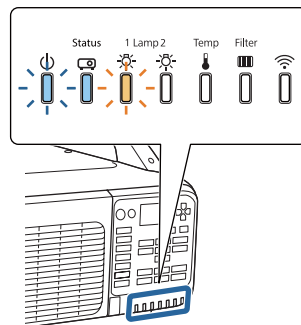

- The projected image gets darker or starts to deteriorate.

### Attention

- Make sure you use the specified lamps. When performing portrait projection, make sure you use the portrait mode lamps.  
Standard replacement lamps: ELPLP81 (one pack)/ELPLP82 (two packs)  
Portrait mode lamps for replacement: ELPLP83 (one pack)/ELPLP84 (two packs)
- Do not use standard replacement lamps for portrait projection. Also, only use the portrait mode lamps for portrait projection.
- Make sure you attach lamps on both Lamp 1 and Lamp 2. Attach the same type of lamps on both Lamp 1 and Lamp 2.
- The lamp replacement message is set to appear after the following time periods to maintain the initial brightness and quality of the projected images.  
EB-Z10005U/EB-Z10000U/EB-Z11000W/EB-Z11005/EB-Z11000

#### Standard Lamps

When using **Power Consumption** continually at **Normal**: About 1,900 hours  
When using **Power Consumption** continually at **Eco**: About 3,900 hours

#### Portrait mode lamps

About 900 hours

EB-Z9875U/EB-Z9870U/EB-Z9900W

#### Standard Lamps

When using **Power Consumption** continually at **Normal**: About 2,400 hours  
When using **Power Consumption** continually at **Eco**: About 3,900 hours

#### Portrait mode lamps

About 900 hours

EB-Z9750U/EB-Z9800W/EB-Z9870

#### Standard Lamps

When using **Power Consumption** continually at **Normal**: About 2900 hours  
When using **Power Consumption** continually at **Eco**: About 3,900 hours

#### Portrait mode lamps

About 900 hours

## Attention

- If you continue to use the lamp after the replacement period has passed, the possibility that the lamp may explode increases. When the lamp replacement message appears, replace the lamp with a new one as soon as possible, even if it is still working.
- Do not repeatedly turn off the power and immediately back on. Turning the power on and off frequently may shorten the lamp's operating life.
- Depending on the characteristics of the lamp and the way it has been used, the lamp may become darker or stop working before the lamp warning message appears. You should always have a spare lamp unit ready in case it is needed.
- We recommend the use of genuine EPSON spare lamps. The use of non-genuine lamps may affect projection quality and safety. Any damage or malfunction caused by the use of non-genuine lamps may not be covered by Epson's warranty.



- We recommend that you clean the air filter whenever you replace the lamp. This will reduce the deterioration of the replaced lamp.
  - ☛ "Cleaning the Lens" [p.172](#)
  - ☛ "Cleaning the Air Filter" [p.172](#)
- Check the **Lamp Select** settings when you replace the lamp.
  - ☛ "Selecting the lamp" [p.31](#)

## How to replace the lamp

The lamp can be replaced even when the projector is suspended from a ceiling.



### Warning

- When replacing the lamp because it has stopped illuminating, there is a possibility that the lamp may be broken. If replacing the lamp of a projector which has been installed on the ceiling, you should always assume that the lamp is cracked, and you should stand to the side of the lamp cover, not underneath it. Remove the lamp cover gently. Be careful when removing the lamp cover as shards of glass may fall out and could cause an injury. If any shards of glass get into your eyes or mouth, contact your local physician immediately.
- Never disassemble or remodel the lamp. If a modified or disassembled lamp is installed in the projector and used, it could cause a fire, electric shock, or an accident.



### Caution

Wait until the lamp has cooled down sufficiently before removing the lamp cover. If the lamp is still hot, burns or other injuries may result. It takes about one hour after the power has been turned off for the lamp to be cool enough.

**1**

After you turn off the projector's power and the confirmation buzzer beeps twice, disconnect the power cord.



**2** Wait until the lamps have cooled down sufficiently before opening the lamp cover on the back of the projector.

Push the lamp cover lever to the left, and then slide the lamp cover to the left.

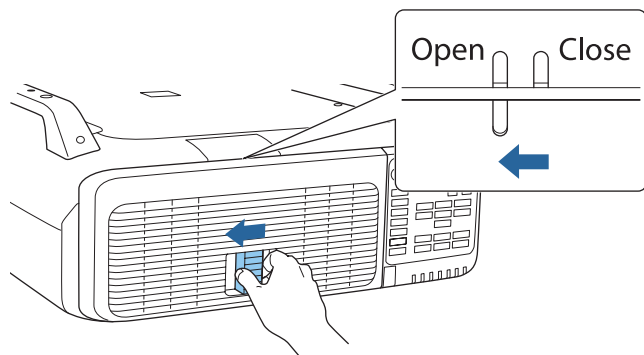

Open the lamp cover.

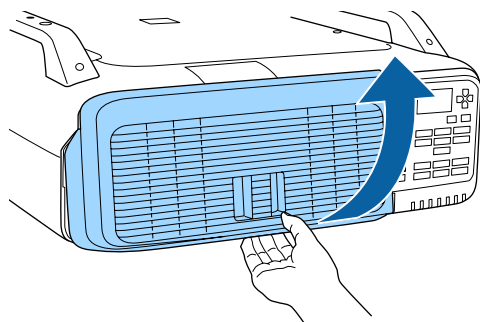

**3** Pull up the lock lever for the lamp you want to replace and pull the lamp straight out.

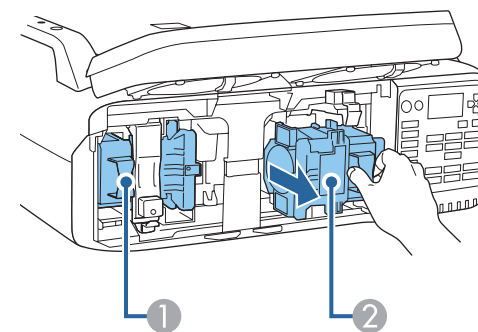
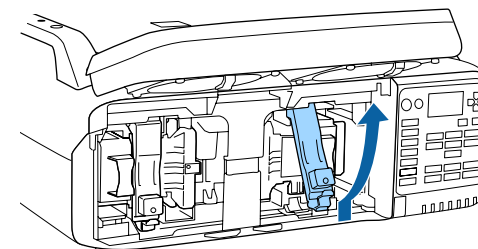

- ① Lamp 1
- ② Lamp 2

## 4 Attach the new lamp.

Insert the lamp along the guide rail in the correct direction so that it fits in place and press it firmly all the way to the back. Pull down the lock lever until it clicks into place.

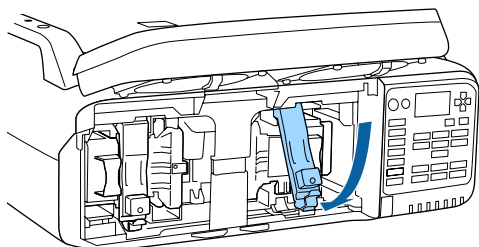
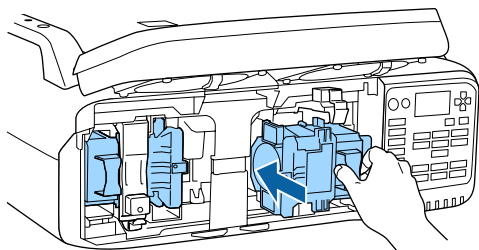

## 5 Close the lamp cover.

Press the cover against the unit and slide it to the right until it clicks.

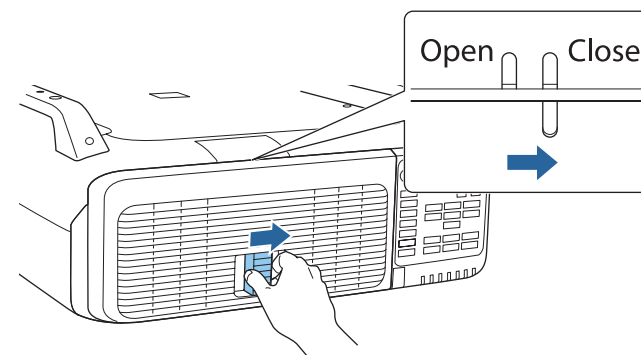
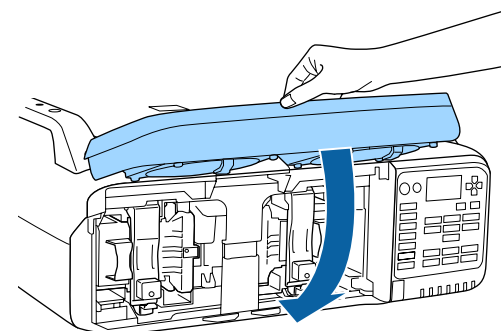

### Attention

- Make sure you attach the lamp securely. If the lamp cover is opened, the power turns off automatically as a safety precaution. If the lamp or the lamp cover is not attached correctly, the power does not turn on.
- This product includes a lamp component that contains mercury (Hg). Please consult your local regulations regarding disposal or recycling. Follow the disposal regulations of your workplace if they apply.

## Resetting the lamp hours

The projector records how long the lamps are turned on and a message and indicator notify you when it is time to replace the lamp. After replacing the lamps and turning on the power, the following message is displayed on the screen and you can reset the Lamp Hours counter.

Select **Yes**, and then press the [**↵**] button.

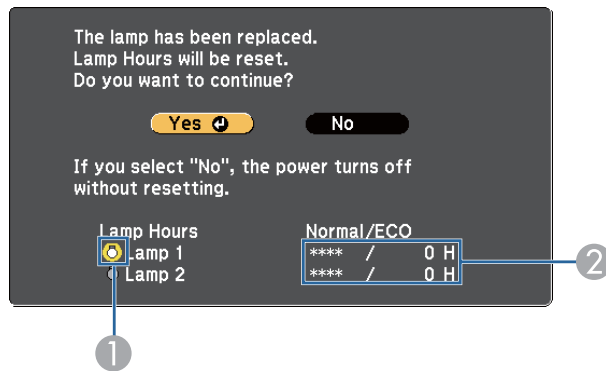

- ① Indicates that Lamp1 has been replaced.
- ② Indicates the cumulative lamp operating time. If you select **Yes** and reset the Lamp Hours, the count for Lamp 1 is set to 0H.

## Replacing the Air Filter

### Air filter replacement period

If the message is displayed frequently even though the air filter has been cleaned, replace the air filter.

### How to replace the air filter

The air filter can be replaced even when the projector is suspended from a ceiling.

- 1** After you turn off the projector's power and the confirmation buzzer beeps twice, disconnect the power cord.
- 2** Remove the air filter cover. Grip the air filter cover tab between your fingers, and pull up and remove the cover while pressing the tab.

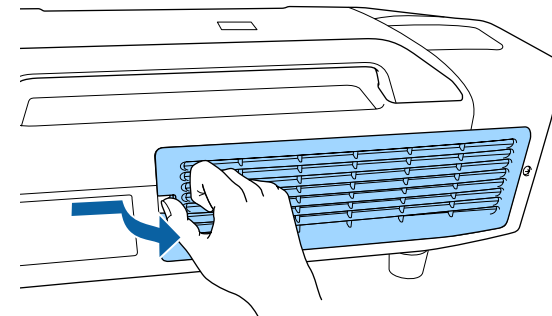

**3** Remove the air filter.

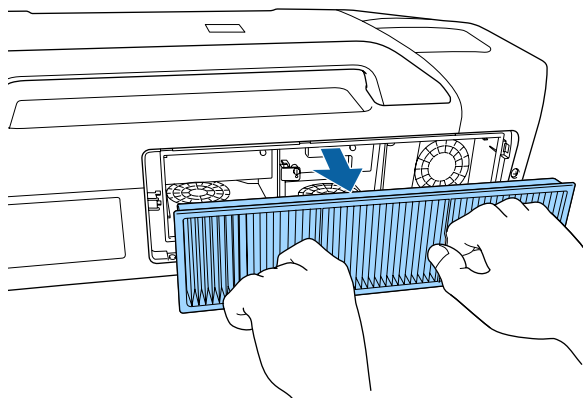

**4** Attach the new air filter.

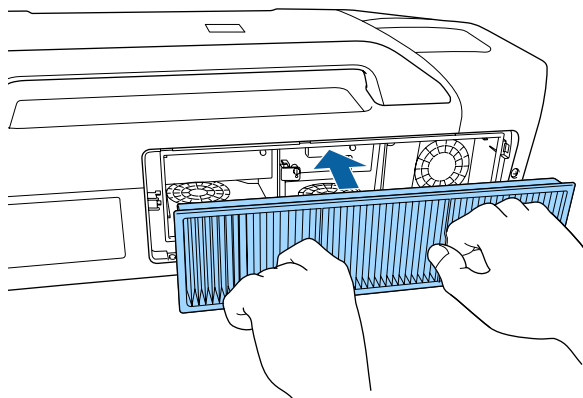

**5** Attach the air filter cover.  
Press the air filter cover until it clicks into place.

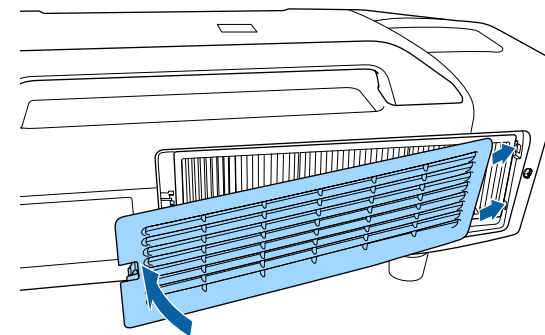

Dispose of used air filters properly in accordance with your local regulations.

Material of the frame part: Polypropylene

Material of the filter part: Polypropylene

## Panel Alignment

Adjusts the pixel color shift for the LCD panel. You can adjust the pixels horizontally and vertically by 0.25 pixel within a range of  $\pm 1$  pixel.



- Image quality may decline after performing Panel alignment.
- Images for pixels that extend beyond the edge of the projected screen are not displayed.

- 1 Press the [Menu] button while projecting.
- 2 Select **Display** from **Extended**.
- 3 Select **Panel Alignment**, and then press the [ $\leftarrow$ ] button.

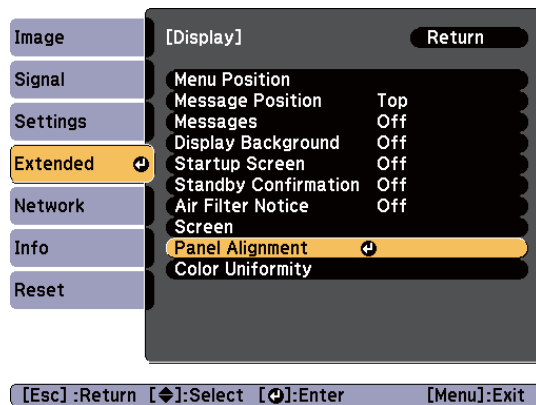

- 4 Enable **Panel Alignment**.

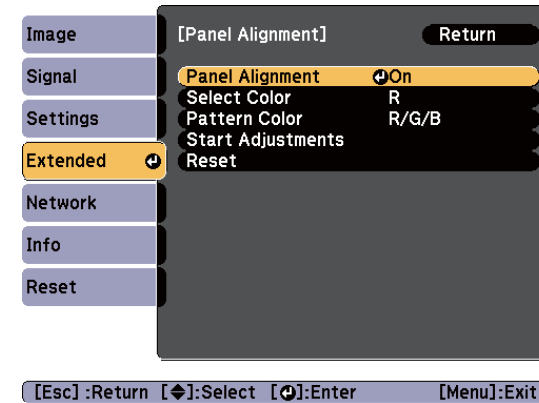

- (1) Select **Panel Alignment**, and then press the [ $\leftarrow$ ] button.
- (2) Select **On**, and then press the [ $\leftarrow$ ] button.
- (3) Press the [Esc] button to return to the previous screen.

- 5 Select the color you want to adjust.

- (1) Select **Select Color**, and then press the [ $\leftarrow$ ] button.
- (2) Select **R** (red) or **B** (blue), and then press the [ $\leftarrow$ ] button.
- (3) Press the [Esc] button to return to the previous screen.

- 6** Select the grid color displayed when making adjustments from **Pattern Color**.
- (1) Select **Pattern Color**, and then press the [**↵**] button.
  - (2) Select a combination of R (red), G (green), and B (blue) for the grid color.
 

**R/G/B:** Displays a combination of all three colors; red, green and blue. The actual color of the grid is white.

**R/G:** This is available when **R** is selected from **Select Color**. Displays a combination of two colors; red and green. The actual color of the grid is yellow.

**G/B:** This is available when **B** is selected from select color. Displays a combination of two colors; green and blue. The actual color of the grid is cyan.
  - (3) Press the [Esc] button to return to the previous screen.

- 7** Select **Start Adjustments**, and then press the [**↵**] button. When a message is displayed, press the [**↵**] button again.
- Adjustment starts. All four corners are adjusted in order starting at the top left.



The image may become distorted while adjusting. The image is restored once adjustments are complete.

- 8** Press the [**▲**][**▼**][**◀**][**▶**] buttons to make adjustments, and then press the [**↵**] button to move to the next adjustment point.
- 9** When you have adjusted all four corners, select **Exit**, and then press the [**↵**] button.

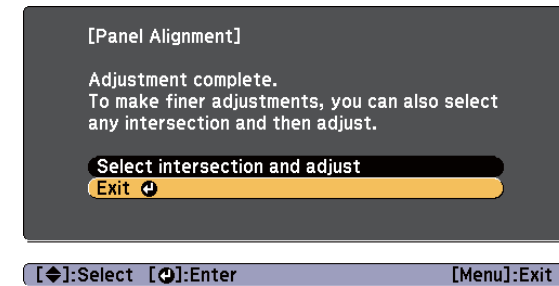

If you feel you still need to make adjustments after correcting all four corners, select **Select intersection and adjust** and then continue making adjustments.

## Color Uniformity

Adjust the color tone for the whole screen.



- The color tone may not be uniform even after performing color uniformity.
- You can also adjust from **Color Uniformity** in **Multi-Projection**.

- 1 Press the [Menu] button while projecting.
- 2 Select **Display** from **Extended**.
- 3 Select **Color Uniformity**, and then press the [↵] button.
- 4 Enable **Color Uniformity**.

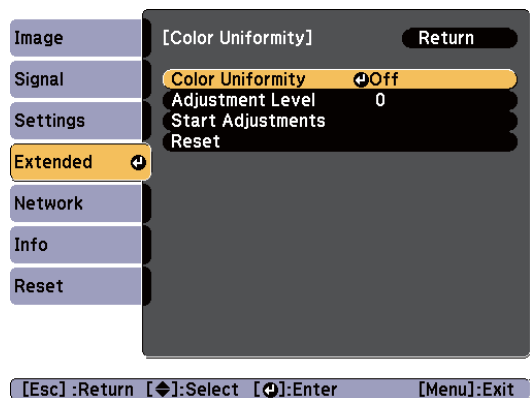

- (1) Select **Color Uniformity**, and then press the [↵] button.
- (2) Select **On**, and then press the [↵] button.
- (3) Press the [Esc] button to return to the previous screen.



The image may become distorted while adjusting **Color Uniformity**. The image is restored once adjustments are complete.

- 5 Select **Adjustment Level**, and then press the [↵] button.
- 6 Press the [◀][▶] buttons to set the adjustment level.
- 7 Press the [Esc] button to return to the previous screen.
- 8 Select **Start Adjustments**, and then press the [↵] button.
- 9 Press the [▲][▼] buttons to select the area you want to adjust, and then press the [↵] button.

Adjust the circumference first. Finally select **All**, and then adjust the whole screen.

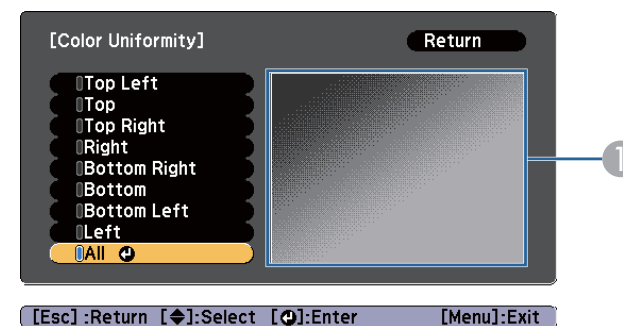

- 1 The adjustment position screen currently selected is focused and displayed.

- 10** Press the [▲][▼] buttons to select the color you want to adjust, and then use the [◀][▶] buttons to adjust.

Press the [◀] button to weaken the color tone. Press the [▶] button to strengthen the color tone.

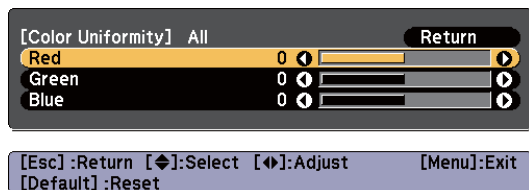

The adjustment screen changes each time you press [↵].

- 11** Return to step 5 and adjust each level.
- 12** To complete the adjustment, press the [Menu] button.





# Appendix

## About EasyMP Monitor

EasyMP Monitor allows you to use the computer to check the status of multiple Epson projectors on the network as well as control them.

You can download EasyMP Monitor from the following Web site.

<http://www.epson.com>

## About Message Broadcasting

Message Broadcasting is plugin software for EasyMP Monitor.

Message Broadcasting can be used to send a message (JPEG file) to project on all Epson projectors or specified projectors connected on the network.

The data can be sent manually, or sent automatically using Timer Settings in EasyMP Monitor.

Download the Message Broadcasting software from the following website.

<http://www.epson.com>

## Changing Settings Using a Web Browser (Web Control)

By using the Web browser of a computer connected to the projector on a network, you can make settings and control the projector. This function allows you to perform setup and control operations remotely. In addition, since you can use the computer's keyboard, entering characters required for the setup is easier.

Use Internet Explorer 8.0 or later as the Web browser. Use Safari for OS X.



- If you set **Standby Mode** to **Communication On**, you can use the Web browser to make settings and perform control even if the projector is in standby mode (when the power is off).
  - ☛ **Extended - Standby Mode** [p.122](#)
- When the menu cannot be displayed on one screen, adjust the zoom setting in your Web browser.

## Setting the projector

In the Web browser, you can set items that are usually set in the projector's Configuration menu. The settings are reflected in the Configuration menu.

Items in the Configuration menu that cannot be set by the Web browser

- Settings - User Button
- Extended - User's Logo
- Advanced - BNC Sync Termination, Shutter Button
- Extended - Language

The settings for items on each menu are the same as the projector's Configuration menu.

☛ "Configuration Menu" [p.113](#)

Items that can only be set with a web browser

- SNMP Community Name (up to 32 single-byte alphanumeric characters)
- Monitor Password (up to 16 single-byte alphanumeric characters)
- HTTP port  
Add the port used for Web control. However, the following ports cannot be added.  
80 (default), 843, 3620, 3621, 3625, 3629, 4352, 4649, 5357, 10000, 10001, 41794

## Displaying the Web Control Screen

Use the following procedure to display the Web Control screen.

Make sure the computer and projector are connected to the network.



If your Web browser is set up to connect via a proxy server, the Web Control screen cannot be displayed. To display Web control, you need to make settings so that a proxy server is not used for a connection.

- 1** Start the Web browser on the computer.
- 2** Enter the IP address of the projector in the address input box of the Web browser, and press the Enter key on the computer's keyboard.  
The Web Control screen is displayed.  
When Web Control Password is set in the Network menu from the projector's Configuration menu, the password entry screen is displayed.
- 3** The user ID and password entry screen is displayed.  
Enter "EPSONWEB" as the user ID.  
The default password is "admin".



- Enter the user ID even if the password setting is disabled. You cannot change the user ID.
- You can change the password in the Network menu in the Configuration menu.  
☛ **Network - Basic - Web Control Password** p.129

## Using the Using Mail Notification to Report Problems

When you set the mail notification function, notification messages are sent to the preset email addresses when a problem or warning occurs with a projector. This allows operators to be notified of problems with projectors even when they are at remote locations.

☛ **Network - Mail - Mail Notification** p.127



- Up to a maximum of three notification destinations (addresses) can be registered, and notification messages can be sent to all three destinations at once.
- If a projector develops a critical problem and suddenly stops working, it may not be able to send a message notifying an operator of the problem.
- If you set **Standby Mode** to **Communication On**, you can control the projector even if it is in standby mode (when the power is off).  
☛ **Extended - Standby Mode** p.122

## Reading error notification emails

When the mail notification function is set to On and a problem or warning occurs in the projector, the following email will be sent.

Mail sender: Address for Address 1

Subject: EPSON Projector

Line 1: The projector name where the problem has occurred

Line 2: The IP address set for the projector where the problem has occurred.

Line 3 and on: Details of the problem

The details of the problem are listed line by line. The main message contents are listed below.

- Clean Air Filter
- No Air Filter
- Internal error
- Fan related error
- Sensor error
- Lamp timer failure
- Lamp Warning (1)/Lamp Warning (2)
- Lamp out
- Lamp type mismatch
- Incorrect projection mode
- Internal temperature error
- High-speed cooling in progress
- Lamp replacement notification (1)/Lamp replacement notification (2)
- Low Air Flow

- Low Air Flow Error
- Peltier Device error/ Pump Error
- Shutter Warning
- Shutter Error
- Cinema Filter Warning
- Cinema Filter Error
- No-signal  
No image signal is input to the projector. Check the connection status or check that the power for the signal source is turned on.
- Auto Iris Error
- Power Warning. (Ballast) (1)/Power Warning. (Ballast) (2)
- Power Err. (Ballast)

See the following to deal with problems or warnings.

☛ "Reading the Indicators" [p.141](#)

## Management Using SNMP

By setting **SNMP** to **On** in the Configuration menu, notification messages are sent to the specified computer when a problem or warning occurs. This allows operators to be notified of problems with projectors even when they are at remote locations.

☛ **Network - Others - SNMP** [p.116](#)



- SNMP should be managed by a network administrator or someone who is familiar with the network.
- To use the SNMP function to monitor the projector, you need to install the SNMP manager program on your computer.
- The SNMP Agent for this projector complies with version 1 (SNMPv1).
- The managing function using SNMP cannot be used over wireless LAN in Quick connection mode.
- Up to two destination IP addresses can be saved.

## Displaying the Web Remote Screen

The Web Remote function allows you to perform projector remote control operations with a Web browser.

**1** Display the Web Control screen.

**2** Click **Web Remote**.

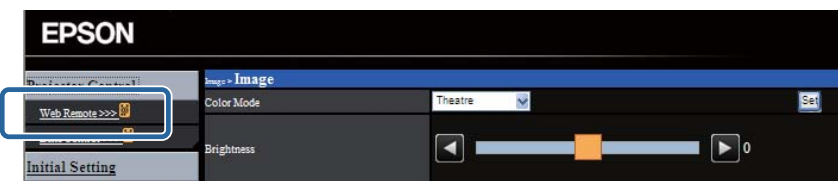

**3** The Web Remote screen is displayed.

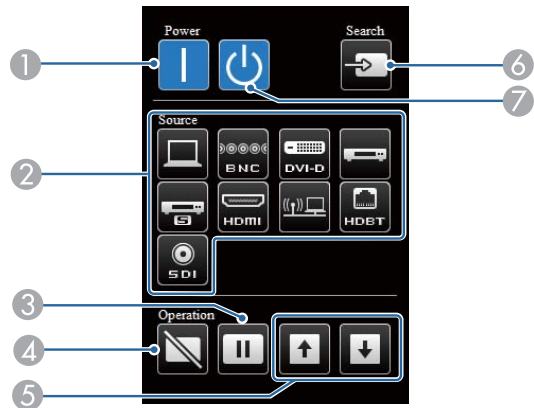

- ① **[①] button**  
Turns the projector on.
- ② **Change input buttons**  
☛ "Switching to the Target Image" p.59
- ③ **[Freeze] button**  
☛ "Freezing the Image (Freeze)" p.95
- ④ **[Shutter] button**  
☛ "Hiding the Image Temporarily (Shutter)" p.94
- ⑤ **[Page] buttons**  
☛ "Remote Control" p.20
- ⑥ **[Search] button**  
☛ "Automatically Detect Input Signals and Change the Projected Image (Search)" p.58
- ⑦ **[⏻] button**  
Turns the projector off.

## Operating the lens

You can operate the lens from a Web browser using **Lens Control** on the Web Control screen.

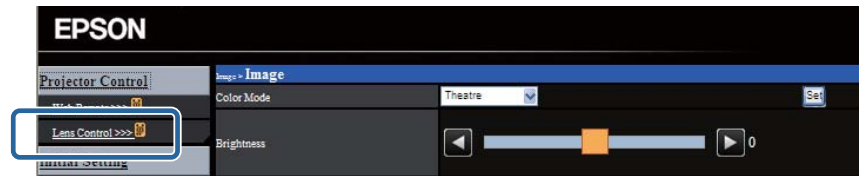

You can adjust the **Focus**, **Zoom**, and **Lens Shift**.

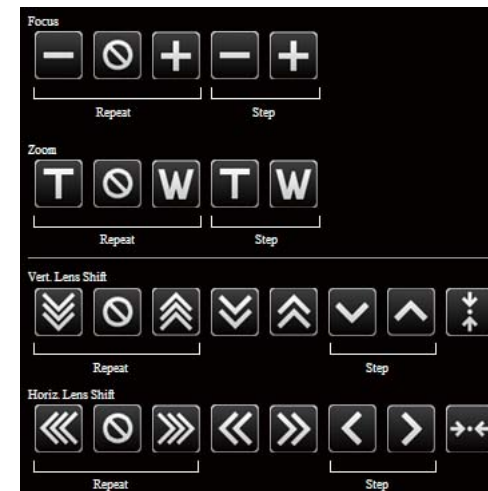

Item	Function
<b>Repeat</b>	Shifts the lens to the maximum or minimum motion range.
	Stops the shift.
<b>Step</b>	Shifts the lens for the predetermined range.
	Shift the lens to the center.

## ESC/VP21 Commands

You can control the projector from an external device using ESC/VP21.

### Command list

When the power ON command is transmitted to the projector, the power turns on and it enters warm-up mode. When the projector's power has turned on, a colon ":" (3Ah) is returned.

When a command is input, the projector executes the command and returns a ":", and then accepts the next command.

If the command being processed terminates abnormally, an error message is output and a ":" is returned.

The main contents are listed below.

Item		Command	
Power ON/OFF	On	PWR ON	
	Off	PWR OFF	
Signal selection	Computer	Auto	SOURCE 1F
		RGB	SOURCE 11
		Component	SOURCE 14
	BNC	Auto	SOURCE BF
		RGB	SOURCE B1
		Component	SOURCE B4
	DVI-D	SOURCE A0	
	HDMI	SOURCE 30	
	Video	SOURCE 41	
	S-Video	SOURCE 42	
LAN	SOURCE 53		

Item		Command
	SDI (For EB-Z10005U/EB-Z10000U/EB-Z9875U/EB-Z9870U only)	SOURCE 60
	HDBaseT	SOURCE 80
Shutter function On/Off	On	MUTE ON
	Off	MUTE OFF

Add a Carriage Return (CR) code (0Dh) to the end of each command and transmit.

For more details, contact your local dealer or the nearest address provided in the Epson Projector Contact List.

 [Epson Projector Contact List](#)

## Cable layouts

### Serial connection

- Connector shape: D-Sub 9-pin (male)

- Projector input port name: RS-232C

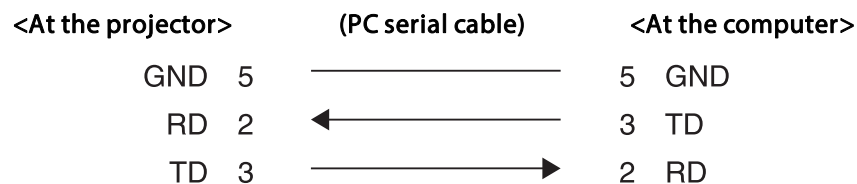
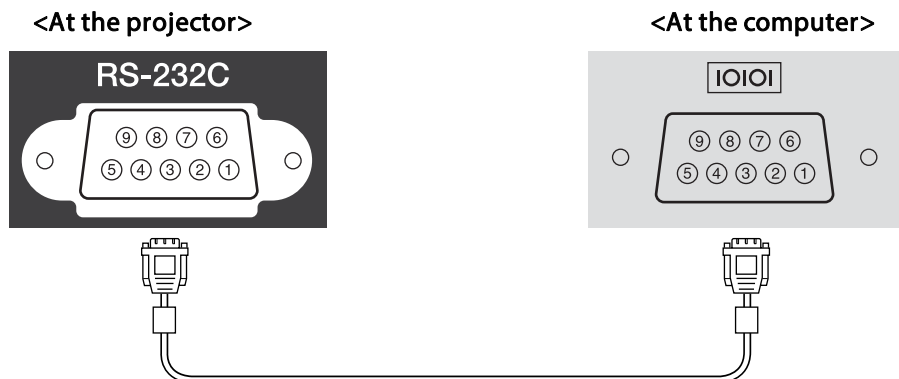

Signal Name	Function
GND	Signal wire ground
TD	Transmit data
RD	Receive data

## Communications protocol

- Default baud rate setting: 9600 bps
- Data length: 8 bit
- Parity: None
- Stop-bit: 1 bit
- Flow control: None

## About PJLink

PJLink Class1 was established by the JBMIA (Japan Business Machine and Information System Industries Association) as a standard protocol for controlling network-compatible projector's as part of their efforts to standardize projector control protocols.

The projector complies with the PJLink Class1 standard established by the JBMIA.

You need to make network settings before you can use PJLink. See the following for more information on network settings.

☛ "Network Menu" [p.127](#)

It complies with all commands except for the following commands defined by PJLink Class1, and agreement was confirmed by the PJLink standard adaptability verification.

URL:<http://pjlink.jbmia.or.jp/english/>

- **Non-compatible commands**

	Function	PJLink Command
Mute settings	Image muting set	AVMT 11
	Audio muting set	AVMT 21

- **Input names defined by PJLink and corresponding projector sources**

Source	PJLink Command
Computer	INPT 11
BNC	INPT 13
Video	INPT 21
S-Video	INPT 22
DVI-D	INPT 31
HDMI	INPT 32



Source	PJLink Command
SDI (For EB-Z10005U/EB-Z10000U/EB-Z9875U/EB-Z9870U only)	INPT 34
LAN	INPT 52
HDBaseT	INPT 56

- Manufacturer name displayed for "Manufacture name information query"  
EPSON
- Model name displayed for "Product name information query"  
EPSON 10005/10000  
EPSON 9875/9870  
EPSON 9750  
EPSON 11000  
EPSON 9900  
EPSON 9800  
EPSON 11005/11000  
EPSON 9870

## About Crestron RoomView®

Crestron RoomView® is an integrated control system provided by Crestron®. It can be used to monitor and control multiple devices connected on a network.

The projector supports the control protocol, and can therefore be used in a system built with Crestron RoomView®.

Visit the Crestron® Web site for details on Crestron RoomView®. (Only English-language displays are supported.)

<http://www.crestron.com>

The following provides an overview of Crestron RoomView®.

- **Remote operation using a Web browser**

You can operate a projector from your computer just like using a remote control.

- **Monitoring and control with application software**

You can use Crestron RoomView® Express or Crestron RoomView® Server Edition provided by Crestron® to monitor devices in the system, to communicate with the help desk, and to send emergency messages. See the following Web site for details.

<http://www.crestron.com/getroomview>

This manual describes how to perform operations on your computer using a Web browser.



- You can only enter single-byte alphanumeric characters and symbols.
- The following functions cannot be used while using Crestron RoomView®.  
Message Broadcasting (EasyMP Monitor plug-in)  
☛ "Changing Settings Using a Web Browser (Web Control)" p.186
- If you set **Standby Mode** to **Communication On**, you can control the projector even if it is in standby mode (when the power is off).  
☛ **Extended - Standby Mode** p.122

## Operating the projector from the computer

### Displaying the operation window

Check the following before carrying out any operations.

- Make sure the computer and projector are connected to the network.
- Set **Crestron RoomView** to **On** in the **Network** menu.  
☛ **Network - Others - Crestron RoomView** p.134

- Start the Web browser on the computer.
- Enter the IP address of the projector in the address input box of the Web browser, and press the Enter key on the computer's keyboard.  
The operation window is displayed.

Using the operation window

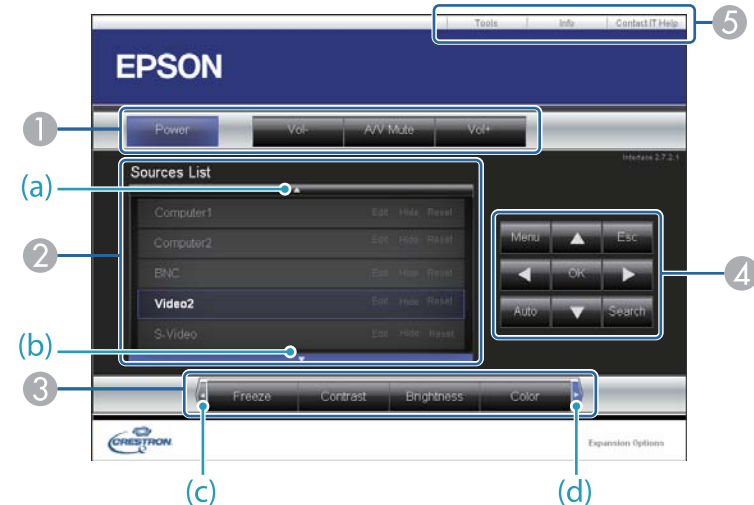



- You can perform the following operations when you click the buttons.



Button	Function
<b>Power</b>	Turns the projector power on or off.
<b>A/V Mute</b>	Press to turn the image on or off temporarily. ☛ "Hiding the Image Temporarily (Shutter)" p.94

- Switch to the image from the selected input source. To display input sources that are not shown in Source List, click (a) or (b) to scroll up or down. The current image signal input source is displayed in blue.  
You can change the source name if necessary.

- 3 You can perform the following operations when you click the buttons. To display buttons that are not shown in Source List, click (c) or (d) to scroll left or right.

Button	Function
<b>Freeze</b>	Press to pause or unpause the images.  "Freezing the Image (Freeze)" <a href="#">p.95</a>
<b>Contrast</b>	Adjusts the difference between light and shade in the images.
<b>Brightness</b>	Adjusts the image brightness.
<b>Color</b>	Adjusts the color saturation for the images.
<b>Sharpness</b>	Adjusts the image sharpness.
<b>Zoom</b>	Click the [⊕] button to enlarge the image without changing the projection size. Click the [⊖] button to reduce an image that was enlarged with the [⊕] button. Click the [▲] [▼] [◀] [▶] buttons to change the position of an enlarged image.  "Enlarging Part of the Image (E-Zoom)" <a href="#">p.95</a>

- 4 The [▲] [▼] [◀] [▶] buttons perform the same operations as the [▲] [▼] [◀] [▶] buttons on the remote control. You can perform the following operations when you click the other buttons.

Button	Function
<b>OK</b>	Performs the same operation as the [↵] button on the remote control.  "Remote Control" <a href="#">p.20</a>
<b>Menu</b>	Press to display and close the Configuration menu.
<b>Auto</b>	If clicked while projecting analog RGB signals from the Computer input port, you can automatically optimize Tracking, Sync., and Position.
<b>Search</b>	Press to change to the next input source that is sending an image.  "Automatically Detect Input Signals and Change the Projected Image (Search)" <a href="#">p.58</a>
<b>Esc</b>	Performs the same operation as the [Esc] button on the remote control.  "Remote Control" <a href="#">p.20</a>

- 5 You can perform the following operations when you click the tabs.

Tab	Function
<b>Contact IT Help</b>	Displays the Help desk window. Used to send messages to, and receive messages from, the administrator using Crestron RoomView® Express.
<b>Info</b>	Displays information on the projector that is currently connected.
<b>Tools</b>	Changes settings in the projector that is currently connected. See the next section.

Using the tools window

The following window is displayed when you click the **Tools** tab on the operation window. You can use this window to change settings in the projector that is currently connected.

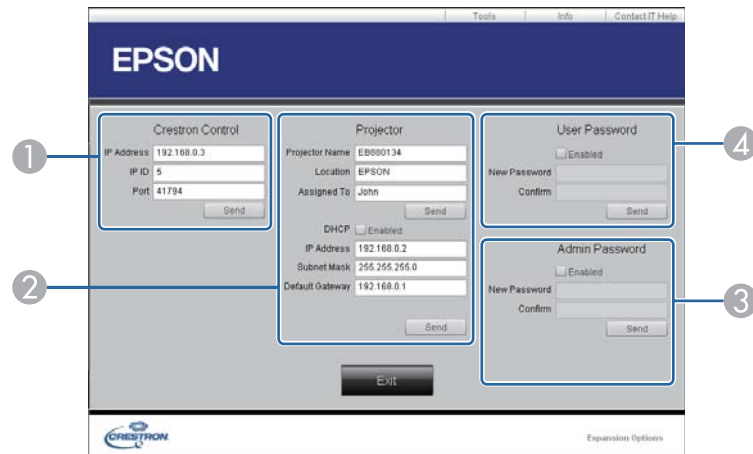

- 1 **Crestron Control**  
Make settings for Crestron® central controllers.
- 2 **Projector**  
The following items can be set.

Item	Function
<b>Projector Name</b>	Enter a name to differentiate the projector that is currently connected from other projectors on the network. (The name can contain up to 15 single-byte alphanumeric characters.)

Item	Function
<b>Location</b>	Enter an installation location name for the projector that is currently connected on the network. (The name can contain up to 32 single-byte alphanumeric characters and symbols.)
<b>Assigned To</b>	Enter a user name for the projector. (The name can contain up to 32 single-byte alphanumeric characters and symbols.)
<b>DHCP</b>	Select <b>Enabled</b> to use DHCP. You cannot enter an IP address if DHCP is enabled.
<b>IP Address</b>	Enter the IP address to assign to the currently connected projector.
<b>Subnet Mask</b>	Enter a subnet mask for the currently connected projector.
<b>Default Gateway</b>	Enter the gateway address for the currently connected projector.
<b>Send</b>	Click this button to confirm the changes made to the <b>Projector</b> .

- 3 **Admin Password**  
Select the Enabled check box to require a password to open the **Tools** window. The following items can be set.

Item	Function
<b>New Password</b>	Enter the new password when changing the password to open the Tools window. (The name can contain up to 26 single-byte alphanumeric characters.)
<b>Confirm</b>	Enter the same password as you entered in <b>New Password</b> . If the passwords are not the same, an error is displayed.
<b>Send</b>	Click this button to confirm the changes made to the <b>Admin Password</b> .



#### 4 User Password

Select the **Enabled** check box to require a password to open the operation window on the computer.

The following items can be set.

Item	Function
<b>New Password</b>	Enter the new password when changing the password to open the operation window. (The name can contain up to 26 single-byte alphanumeric characters.)
<b>Confirm</b>	Enter the same password as you entered in <b>New Password</b> . If the passwords are not the same, an error is displayed.
<b>Send</b>	Click this button to confirm the changes made to the <b>User Password</b> .

The following optional accessories and consumables are available. Purchase these products as and when needed. The following list of optional accessories and consumables is current as of: April, 2014. Details of accessories are subject to change without notice and availability may vary depending on the country of purchase.

## Optional Accessories

### Standard zoom lens ELPLS04

### Short throw zoom lens ELPLU02

### Rear projection wide lens ELPLR04

### Wide zoom lens ELPLW04

### Middle throw zoom lens ELPLM06

### Middle throw zoom lens ELPLM07

### Long throw zoom lens ELPLL07

See the following for more information on the projection distance for each lens.

 "Screen Size and Projection Distance" [p.200](#)

### Computer cable ELPKC02

(1.8 m - for mini D-Sub15-pin/mini D-Sub 15pin)

This is the same as the computer cable supplied with the projector.

### Computer cable ELPKC09

(3 m - for mini D-Sub15-pin/mini D-Sub 15pin)

### Computer cable ELPKC10

(20 m - for mini D-Sub15-pin/mini D-Sub 15pin)

Use one of these longer cables if the computer cable supplied with the projector is too short.

### Component video cable ELPKC19

(3 m - for mini D-Sub 15-pin/RCA male×3)

Use to connect a [component video](#) source.

### Remote control cable set ELPKC28

(10 m 2 piece set)

Use this to guarantee operation from the remote control from a distance.

### Wireless mouse receiver ELPST16

Use this to use the projector's remote control to control the mouse pointer on the computer or to page up and down.

### HDBaseT Transmitter ELPHD01

This transmitter performs long distance transmissions for HDMI signals and control signals for 1 LAN cable. Based on the [HDBaseT](#) standard.

### Document Camera ELPDC11/ELPDC20

Use when projecting images such as books, OHP documents, or slides.

### Wireless LAN unit ELPAP07

Use when connecting the projector to a computer wirelessly and projecting.

### Quick Wireless Connection USB Key ELPAP09

Use when you want to quickly establish one-to-one connection between the projector and a computer with Windows installed.

### Polarizer ELPLL01

This is only available for standard zoom lens ELPLS04, middle throw zoom lens ELPLM06, and long throw zoom lens ELPLL07.

Attach to this projector when stacking two projectors and projecting 3D images.

### Passive 3D Glasses (standard five piece set) ELPGS02A

### Passive 3D Glasses (five piece set for children) ELPGS02B

Passive polarized 3D glasses. Use these when viewing 3D images with the projectors.

### Frame ELPMB44

Metal mount used to install the projector for portrait projection or stack projection.

**Low ceiling mount\* ELPMB25****High ceiling mount\* ELPMB26**

Use when installing the projector on a ceiling.

- \* Special expertise is required to suspend the projector from a ceiling. Contact your local dealer or the nearest address provided in the Epson Projector Contact List.

 [Epson Projector Contact List](#)

---

## Consumables

**Lamp unit (one pack) ELPLP81****Lamp unit (two packs) ELPLP82**

Use as a replacement for used lamps.

**Lamp unit (for portrait use) (one pack) ELPLP83****Lamp unit (for portrait use) (two packs) ELPLP84**

Use for portrait projection.

**Air Filter ELPAF46**

Use as a replacement for used air filter.

## for EB-Z10005U/EB-Z10000U/EB-Z9875U/EB-Z9870U/EB-Z9750U/EB-Z11000W/EB-Z9900W/EB-Z9800W

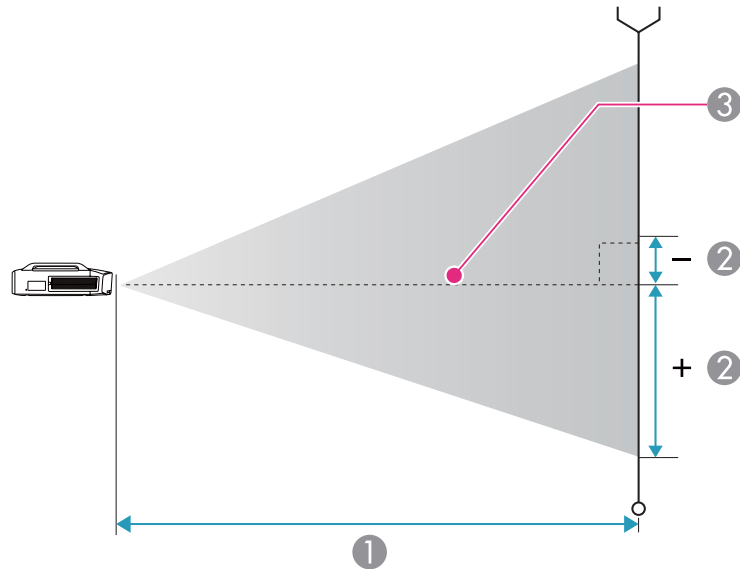

- ① Projection distance
- ② Distance from the center of the lens to the base of the image. This varies depending on the setting for vertical lens shift.
- ③ Center of lens

### Standard zoom lens ELPLS04

This section shows the projection distances for models equipped with the standard zoom lenses.

Unit: cm

16:10 Screen Size		①	②
		Minimum (Wide) to Maximum (Tele)	Vertical Lens Shift Top to Bottom
60"	130x81	199 - 326	-8 - +89
70"	151x94	233 - 382	-9 - +104
80"	172x108	268 - 438	-11 - +119
90"	194x121	302 - 493	-12 - +133
100"	215x135	337 - 549	-14 - +148
120"	258x162	406 - 661	-16 - +178
150"	323x202	509 - 828	-20 - +222
200"	431x269	682 - 1106	-27 - +296
250"	538x337	855 - 1385	-34 - +370
300"	646x404	1027 - 1663	-41 - +444
350"	754x471	1200 - 1942	-47 - +519
400"	862x538	1372 - 2220	-54 - +593
450"	969x606	1545 - 2499	-61 - +667
500"	1077x673	1717 - 2777	-68 - +741

Unit: cm

16:9 Screen Size		①	②
		Minimum (Wide) to Maximum (Tele)	Vertical Lens Shift Top to Bottom
59"	131x73	201 - 330	-12 - +86
60"	133x75	205 - 336	-13 - +87





16:9 Screen Size		①	②
		Minimum (Wide) to Maximum (Tele)	Vertical Lens Shift Top to Bottom
70"	155x87	240 - 393	-15 - +102
80"	177x100	276 - 450	-17 - +116
90"	199x112	311 - 507	-19 - +131
100"	221x125	347 - 565	-21 - +145
120"	266x149	417 - 679	-25 - +174
150"	332x187	524 - 851	-31 - +218
200"	443x249	701 - 1137	-42 - +291
250"	553x311	879 - 1423	-52 - +363
300"	664x374	1056 - 1710	-63 - +436
350"	775x436	1233 - 1996	-73 - +509
400"	886x498	1411 - 2282	-83 - +581
450"	996x560	1588 - 2569	-94 - +654
486"	1076x605	1716 - 2775	-101 - +706

Unit: cm

4:3 Screen Size		①	②
		Minimum (Wide) to Maximum (Tele)	Vertical Lens Shift Top to Bottom
53"	108x81	199 - 326	-8 - +89
60"	122x91	226 - 370	-9 - +101
70"	142x107	265 - 433	-11 - +117
80"	163x122	304 - 497	-12 - +134
90"	183x137	343 - 560	-14 - +151
100"	203x152	383 - 623	-15 - +168
120"	244x183	461 - 749	-18 - +201

4:3 Screen Size		①	②
		Minimum (Wide) to Maximum (Tele)	Vertical Lens Shift Top to Bottom
150"	305x229	578 - 938	-23 - +252
200"	406x305	773 - 1253	-31 - +335
250"	508x381	969 - 1569	-38 - +419
300"	610x457	1164 - 1884	-46 - +503
350"	711x533	1359 - 2199	-54 - +587
400"	813x610	1555 - 2515	-61 - +671
441"	896x672	1715 - 2773	-68 - +740

### Short throw zoom lens ELPLU02

Unit: cm

16:10 Screen Size		①	②
		Minimum (Wide) to Maximum (Tele)	Vertical Lens Shift Top to Bottom
60"	130x81	80 - 97	-8 - +89
70"	151x94	94 - 114	-9 - +104
80"	172x108	108 - 131	-11 - +119
90"	194x121	122 - 148	-12 - +133
100"	215x135	136 - 165	-14 - +148
120"	258x162	165 - 199	-16 - +178
150"	323x202	207 - 251	-20 - +222
200"	431x269	278 - 336	-27 - +296
250"	538x337	349 - 421	-34 - +370
300"	646x404	420 - 507	-41 - +444
350"	754x471	491 - 592	-47 - +519
400"	862x538	562 - 678	-54 - +593



16:10 Screen Size		①	②
		Minimum (Wide) to Maximum (Tele)	Vertical Lens Shift Top to Bottom
450"	969x606	633 - 763	-61 - +667
500"	1077x673	704 - 848	-68 - +741

Unit: cm

16:9 Screen Size		①	②
		Minimum (Wide) to Maximum (Tele)	Vertical Lens Shift Top to Bottom
59"	131x73	80 - 98	-12 - +86
60"	133x75	82 - 100	-13 - +87
70"	155x87	97 - 117	-15 - +102
80"	177x100	111 - 135	-17 - +116
90"	199x112	126 - 152	-19 - +131
100"	221x125	140 - 170	-21 - +145
120"	266x149	170 - 205	-25 - +174
150"	332x187	213 - 258	-31 - +218
200"	443x249	286 - 346	-42 - +291
250"	553x311	359 - 433	-52 - +363
300"	664x374	432 - 521	-63 - +436
350"	775x436	505 - 609	-73 - +509
400"	886x498	578 - 697	-83 - +581
450"	996x560	651 - 784	-94 - +654
486"	1076x605	704 - 848	-101 - +706

Unit: cm

4:3 Screen Size		①	②
		Minimum (Wide) to Maximum (Tele)	Vertical Lens Shift Top to Bottom
53"	108x81	80 - 97	-8 - +89
60"	122x91	91 - 110	-9 - +101
70"	142x107	107 - 130	-11 - +117
80"	163x122	123 - 149	-12 - +134
90"	183x137	139 - 168	-14 - +151
100"	203x152	155 - 188	-15 - +168
120"	244x183	187 - 226	-18 - +201
150"	305x229	236 - 284	-23 - +252
200"	406x305	316 - 381	-31 - +335
250"	508x381	396 - 478	-38 - +419
300"	610x457	477 - 574	-46 - +503
350"	711x533	557 - 671	-54 - +587
400"	813x610	638 - 768	-61 - +671
441"	896x672	703 - 847	-68 - +740

### Rear projection wide lens ELPLR04

Lens shift is not supported.

Unit: cm

16:10 Screen Size		①	②
60"	130x81	87	+40
70"	151x94	102	+47
80"	172x108	118	+54
90"	194x121	133	+61



16:10 Screen Size		①	②
100"	215x135	149	+67
120"	258x162	180	+81
150"	323x202	227	+101
200"	431x269	304	+135
250"	538x337	382	+168
300"	646x404	460	+202
350"	754x471	538	+236
400"	862x538	615	+269
450"	969x606	693	+303
500"	1077x673	771	+337

Unit: cm

16:9 Screen Size		①	②
59"	131x73	88	+37
60"	133x75	89	+37
70"	155x87	105	+44
80"	177x100	121	+50
90"	199x112	137	+56
100"	221x125	153	+62
120"	266x149	185	+75
150"	332x187	233	+93
200"	443x249	313	+125
250"	553x311	393	+156
300"	664x374	473	+187
350"	775x436	553	+218
400"	886x498	633	+249
450"	996x560	713	+280

16:9 Screen Size		①	②
486"	1076x605	770	+303

Unit: cm

4:3 Screen Size		①	②
53"	108x81	87	+40
60"	122x91	99	+46
70"	142x107	117	+53
80"	163x122	134	+61
90"	183x137	152	+69
100"	203x152	169	+76
120"	244x183	205	+91
150"	305x229	257	+114
200"	406x305	345	+152
250"	508x381	433	+191
300"	610x457	521	+229
350"	711x533	610	+267
400"	813x610	698	+305
441"	896x672	770	+336

## Wide zoom lens ELPLW04

Unit: cm

16:10 Screen Size		①	②
		Minimum (Wide) to Maximum (Tele)	Vertical Lens Shift Top to Bottom
60"	130x81	149 - 206	-8 - +89
70"	151x94	175 - 242	-9 - +104
80"	172x108	202 - 277	-11 - +119



16:10 Screen Size		①	②
		Minimum (Wide) to Maximum (Tele)	Vertical Lens Shift Top to Bottom
90"	194x121	228 - 313	-12 - +133
100"	215x135	254 - 348	-14 - +148
120"	258x162	306 - 419	-16 - +178
150"	323x202	385 - 526	-20 - +222
200"	431x269	515 - 703	-27 - +296
250"	538x337	646 - 881	-34 - +370
300"	646x404	777 - 1058	-41 - +444
350"	754x471	907 - 1236	-47 - +519
400"	862x538	1038 - 1413	-54 - +593
450"	969x606	1169 - 1591	-61 - +667
500"	1077x673	1299 - 1769	-68 - +741

Unit: cm

16:9 Screen Size		①	②
		Minimum (Wide) to Maximum (Tele)	Vertical Lens Shift Top to Bottom
59"	131x73	151 - 208	-12 - +86
60"	133x75	154 - 212	-13 - +87
70"	155x87	181 - 248	-15 - +102
80"	177x100	207 - 285	-17 - +116
90"	199x112	234 - 321	-19 - +131
100"	221x125	261 - 358	-21 - +145
120"	266x149	315 - 431	-25 - +174
150"	332x187	395 - 540	-31 - +218
200"	443x249	530 - 723	-42 - +291

16:9 Screen Size		①	②
		Minimum (Wide) to Maximum (Tele)	Vertical Lens Shift Top to Bottom
250"	553x311	664 - 905	-52 - +363
300"	664x374	798 - 1088	-63 - +436
350"	775x436	933 - 1270	-73 - +509
400"	886x498	1067 - 1453	-83 - +581
450"	996x560	1201 - 1635	-94 - +654
486"	1076x605	1298 - 1767	-101 - +706

Unit: cm

4:3 Screen Size		①	②
		Minimum (Wide) to Maximum (Tele)	Vertical Lens Shift Top to Bottom
53"	108x81	149 - 206	-8 - +89
60"	122x91	170 - 234	-9 - +101
70"	142x107	200 - 274	-11 - +117
80"	163x122	229 - 315	-12 - +134
90"	183x137	259 - 355	-14 - +151
100"	203x152	288 - 395	-15 - +168
120"	244x183	348 - 475	-18 - +201
150"	305x229	436 - 596	-23 - +252
200"	406x305	584 - 797	-31 - +335
250"	508x381	732 - 998	-38 - +419
300"	610x457	880 - 1199	-46 - +503
350"	711x533	1028 - 1400	-54 - +587
400"	813x610	1176 - 1601	-61 - +671
441"	896x672	1298 - 1766	-68 - +740

## Middle throw zoom lens ELPLM06

Unit: cm

16:10 Screen Size		①	②
		Minimum (Wide) to Maximum (Tele)	Vertical Lens Shift Top to Bottom
60"	130x81	306 - 473	-8 - +89
70"	151x94	360 - 554	-9 - +104
80"	172x108	413 - 635	-11 - +119
90"	194x121	466 - 716	-12 - +133
100"	215x135	519 - 797	-14 - +148
120"	258x162	626 - 959	-16 - +178
150"	323x202	786 - 1202	-20 - +222
200"	431x269	1052 - 1607	-27 - +296
250"	538x337	1318 - 2012	-34 - +370
300"	646x404	1585 - 2417	-41 - +444
350"	754x471	1851 - 2822	-47 - +519
400"	862x538	2117 - 3227	-54 - +593
450"	969x606	2383 - 3631	-61 - +667
500"	1077x673	2650 - 4036	-68 - +741

Unit: cm

16:9 Screen Size		①	②
		Minimum (Wide) to Maximum (Tele)	Vertical Lens Shift Top to Bottom
59"	131x73	310 - 478	-12 - +86
60"	133x75	315 - 486	-13 - +87
70"	155x87	370 - 570	-15 - +102
80"	177x100	425 - 653	-17 - +116

16:9 Screen Size		①	②
		Minimum (Wide) to Maximum (Tele)	Vertical Lens Shift Top to Bottom
90"	199x112	479 - 736	-19 - +131
100"	221x125	534 - 819	-21 - +145
120"	266x149	644 - 986	-25 - +174
150"	332x187	808 - 1236	-31 - +218
200"	443x249	1082 - 1652	-42 - +291
250"	553x311	1355 - 2068	-52 - +363
300"	664x374	1629 - 2484	-63 - +436
350"	775x436	1903 - 2900	-73 - +509
400"	886x498	2176 - 3317	-83 - +581
450"	996x560	2450 - 3733	-94 - +654
486"	1076x605	2647 - 4032	-101 - +706

Unit: cm

4:3 Screen Size		①	②
		Minimum (Wide) to Maximum (Tele)	Vertical Lens Shift Top to Bottom
53"	108x81	306 - 473	-8 - +89
60"	122x91	349 - 537	-9 - +101
70"	142x107	409 - 629	-11 - +117
80"	163x122	469 - 720	-12 - +134
90"	183x137	529 - 812	-14 - +151
100"	203x152	590 - 904	-15 - +168
120"	244x183	710 - 1087	-18 - +201
150"	305x229	891 - 1362	-23 - +252
200"	406x305	1193 - 1821	-31 - +335

4:3 Screen Size		①	②
		Minimum (Wide) to Maximum (Tele)	Vertical Lens Shift Top to Bottom
250"	508x381	1494 - 2279	-38 - +419
300"	610x457	1796 - 2738	-46 - +503
350"	711x533	2097 - 3196	-54 - +587
400"	813x610	2399 - 3654	-61 - +671
441"	896x672	2646 - 4030	-68 - +740

Unit: cm

16:9 Screen Size		①	②
		Minimum (Wide) to Maximum (Tele)	Vertical Lens Shift Top to Bottom
59"	131x73	450 - 694	-12 - +86
60"	133x75	458 - 706	-13 - +87
70"	155x87	538 - 828	-15 - +102
80"	177x100	618 - 949	-17 - +116
90"	199x112	698 - 1071	-19 - +131
100"	221x125	779 - 1192	-21 - +145
120"	266x149	939 - 1436	-25 - +174
150"	332x187	1180 - 1800	-31 - +218
200"	443x249	1581 - 2408	-42 - +291
250"	553x311	1983 - 3016	-52 - +363
300"	664x374	2384 - 3624	-63 - +436
350"	775x436	2785 - 4232	-73 - +509
400"	886x498	3187 - 4840	-83 - +581
450"	996x560	3588 - 5448	-94 - +654
486"	1076x605	3877 - 5886	-101 - +706

## Middle throw zoom lens ELPLM07

Unit: cm

16:10 Screen Size		①	②
		Minimum (Wide) to Maximum (Tele)	Vertical Lens Shift Top to Bottom
60"	130x81	445 - 686	-8 - +89
70"	151x94	523 - 805	-9 - +104
80"	172x108	601 - 923	-11 - +119
90"	194x121	679 - 1041	-12 - +133
100"	215x135	757 - 1160	-14 - +148
120"	258x162	913 - 1396	-16 - +178
150"	323x202	1147 - 1751	-20 - +222
200"	431x269	1538 - 2343	-27 - +296
250"	538x337	1928 - 2934	-34 - +370
300"	646x404	2319 - 3526	-41 - +444
350"	754x471	2709 - 4117	-47 - +519
400"	862x538	3100 - 4709	-54 - +593
450"	969x606	3490 - 5300	-61 - +667
500"	1077x673	3881 - 5892	-68 - +741

Unit: cm

4:3 Screen Size		①	②
		Minimum (Wide) to Maximum (Tele)	Vertical Lens Shift Top to Bottom
53"	108x81	445 - 686	-8 - +89
60"	122x91	507 - 780	-9 - +101
70"	142x107	595 - 914	-11 - +117
80"	163x122	683 - 1048	-12 - +134



4:3 Screen Size		①	②
		Minimum (Wide) to Maximum (Tele)	Vertical Lens Shift Top to Bottom
90"	183x137	772 - 1182	-14 - +151
100"	203x152	860 - 1316	-15 - +168
120"	244x183	1037 - 1584	-18 - +201
150"	305x229	1302 - 1985	-23 - +252
200"	406x305	1744 - 2655	-31 - +335
250"	508x381	2186 - 3325	-38 - +419
300"	610x457	2628 - 3995	-46 - +503
350"	711x533	3070 - 4664	-54 - +587
400"	813x610	3512 - 5334	-61 - +671
441"	896x672	3875 - 5883	-68 - +740

16:10 Screen Size		①	②
		Minimum (Wide) to Maximum (Tele)	Vertical Lens Shift Top to Bottom
300"	646x404	3447 - 4830	-41 - +444
350"	754x471	4026 - 5640	-47 - +519
400"	862x538	4606 - 6451	-54 - +593
450"	969x606	5186 - 7261	-61 - +667
500"	1077x673	5765 - 8071	-68 - +741

Unit: cm

## Long throw zoom lens ELPLL07

Unit: cm

16:10 Screen Size		①	②
		Minimum (Wide) to Maximum (Tele)	Vertical Lens Shift Top to Bottom
60"	130x81	664 - 941	-8 - +89
70"	151x94	780 - 1103	-9 - +104
80"	172x108	896 - 1265	-11 - +119
90"	194x121	1012 - 1427	-12 - +133
100"	215x135	1128 - 1589	-14 - +148
120"	258x162	1360 - 1913	-16 - +178
150"	323x202	1708 - 2399	-20 - +222
200"	431x269	2287 - 3209	-27 - +296
250"	538x337	2867 - 4020	-34 - +370

16:9 Screen Size		①	②
		Minimum (Wide) to Maximum (Tele)	Vertical Lens Shift Top to Bottom
59"	131x73	672 - 951	-12 - +86
60"	133x75	683 - 968	-13 - +87
70"	155x87	803 - 1134	-15 - +102
80"	177x100	922 - 1301	-17 - +116
90"	199x112	1041 - 1467	-19 - +131
100"	221x125	1160 - 1634	-21 - +145
120"	266x149	1398 - 1967	-25 - +174
150"	332x187	1756 - 2467	-31 - +218
200"	443x249	2352 - 3300	-42 - +291
250"	553x311	2948 - 4132	-52 - +363
300"	664x374	3543 - 4965	-63 - +436
350"	775x436	4139 - 5798	-73 - +509
400"	886x498	4735 - 6631	-83 - +581
450"	996x560	5331 - 7464	-94 - +654
486"	1076x605	5760 - 8063	-101 - +706

Unit: cm

4:3 Screen Size		①	②
		Minimum (Wide) to Maximum (Tele)	Vertical Lens Shift Top to Bottom
53"	108x81	664 - 941	-8 - +89
60"	122x91	756 - 1069	-9 - +101
70"	142x107	887 - 1252	-11 - +117
80"	163x122	1019 - 1436	-12 - +134
90"	183x137	1150 - 1619	-14 - +151
100"	203x152	1281 - 1803	-15 - +168
120"	244x183	1544 - 2170	-18 - +201
150"	305x229	1937 - 2720	-23 - +252
200"	406x305	2594 - 3637	-31 - +335
250"	508x381	3250 - 4555	-38 - +419
300"	610x457	3906 - 5472	-46 - +503
350"	711x533	4562 - 6389	-54 - +587
400"	813x610	5219 - 7307	-61 - +671
441"	896x672	5757 - 8059	-68 - +740

## Projection Distances for EB-Z11005/EB-Z11000/EB-Z9870

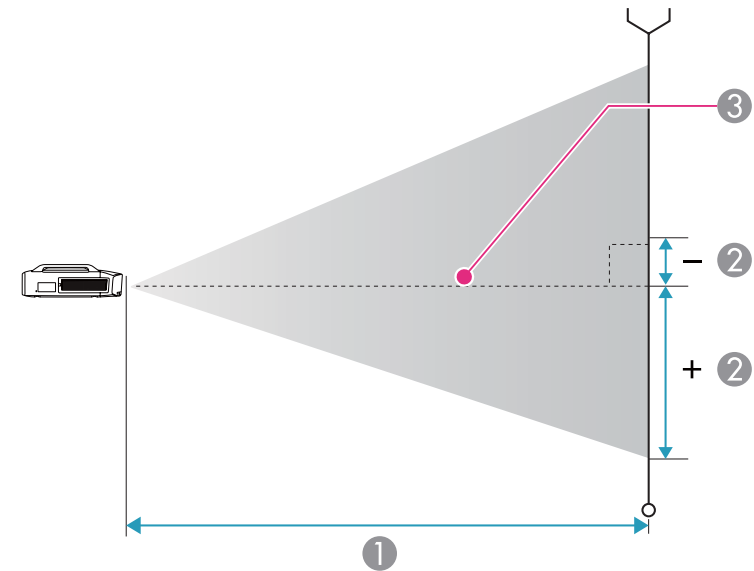

- ① Projection distance
- ② Distance from the center of the lens to the base of the image. This varies depending on the setting for vertical lens shift.
- ③ Center of lens



## Standard zoom lens ELPLS04

This section shows the projection distances for models equipped with the standard zoom lenses.

Unit: cm

4:3 Screen Size		①	②
		Minimum (Wide) to Maximum (Tele)	Vertical Lens Shift Top to Bottom
60"	122x91	194 - 319	-5 - +97
70"	142x107	228 - 373	-6 - +113
80"	163x122	261 - 428	-7 - +129
90"	183x137	295 - 482	-8 - +145
100"	203x152	329 - 537	-8 - +161
120"	244x183	396 - 646	-10 - +193
150"	305x229	497 - 809	-13 - +241
200"	406x305	665 - 1082	-17 - +322
250"	508x381	834 - 1354	-21 - +402
300"	610x457	1002 - 1626	-25 - +483
350"	711x533	1171 - 1899	-30 - +563
400"	813x610	1339 - 2171	-34 - +643
450"	914x686	1508 - 2444	-38 - +724
500"	1016x762	1676 - 2716	-42 - +804

Unit: cm

16:9 Screen Size		①	②
		Minimum (Wide) to Maximum (Tele)	Vertical Lens Shift Top to Bottom
56"	124x70	197 - 324	-17 - +87
60"	133x75	212 - 348	-18 - +93

16:9 Screen Size		①	②
		Minimum (Wide) to Maximum (Tele)	Vertical Lens Shift Top to Bottom
70"	155x87	249 - 407	-21 - +108
80"	177x100	285 - 467	-24 - +124
90"	199x112	322 - 526	-27 - +139
100"	221x125	359 - 586	-30 - +155
120"	266x149	432 - 704	-36 - +185
150"	332x187	542 - 882	-45 - +232
200"	443x249	726 - 1179	-60 - +309
250"	553x311	909 - 1476	-75 - +386
300"	664x374	1093 - 1773	-90 - +464
350"	775x436	1276 - 2069	-105 - +541
400"	886x498	1460 - 2366	-120 - +618
450"	996x560	1643 - 2663	-135 - +695
458"	1014x570	1672 - 2711	-137 - +708

Unit: cm

16:10 Screen Size		①	②
		Minimum (Wide) to Maximum (Tele)	Vertical Lens Shift Top to Bottom
57"	123x77	195 - 321	-13 - +90
60"	130x81	206 - 338	-13 - +94
70"	151x94	242 - 396	-16 - +110
80"	172x108	277 - 454	-18 - +126
90"	194x121	313 - 512	-20 - +141
100"	215x135	349 - 569	-22 - +157
120"	258x162	420 - 685	-27 - +188



16:10 Screen Size		①	②
		Minimum (Wide) to Maximum (Tele)	Vertical Lens Shift Top to Bottom
150"	323x202	527 - 858	-34 - +236
200"	431x269	706 - 1147	-45 - +314
250"	538x337	884 - 1436	-56 - +393
300"	646x404	1063 - 1725	-67 - +471
350"	754x471	1241 - 2013	-79 - +550
400"	862x538	1420 - 2302	-90 - +628
450"	969x606	1598 - 2591	-101 - +707
471"	1014x634	1673 - 2712	-106 - +740

4:3 Screen Size		①	②
		Minimum (Wide) to Maximum (Tele)	Vertical Lens Shift Top to Bottom
400"	813x610	548 - 662	0 - +610
450"	914x686	617 - 745	0 - +686
500"	1016x762	686 - 828	0 - +762

Unit: cm

## Short throw zoom lens ELPLU02

Unit: cm

4:3 Screen Size		①	②
		Minimum (Wide) to Maximum (Tele)	Vertical Lens Shift Top to Bottom
60"	122x91	78 - 95	0 - +91
70"	142x107	91 - 111	0 - +107
80"	163x122	105 - 128	0 - +122
90"	183x137	119 - 145	0 - +137
100"	203x152	133 - 161	0 - +152
120"	244x183	161 - 195	0 - +183
150"	305x229	202 - 245	0 - +229
200"	406x305	271 - 328	0 - +305
250"	508x381	340 - 412	0 - +381
300"	610x457	410 - 495	0 - +457
350"	711x533	479 - 578	0 - +533

16:9 Screen Size		①	②
		Minimum (Wide) to Maximum (Tele)	Vertical Lens Shift Top to Bottom
56"	124x70	79 - 96	-12 - +81
60"	133x75	85 - 104	-12 - +87
70"	155x87	100 - 122	-15 - +102
80"	177x100	115 - 140	-17 - +116
90"	199x112	130 - 158	-19 - +131
100"	221x125	145 - 176	-21 - +145
120"	266x149	175 - 213	-25 - +174
150"	332x187	221 - 267	-31 - +218
200"	443x249	296 - 358	-42 - +291
250"	553x311	371 - 449	-52 - +363
300"	664x374	447 - 540	-62 - +436
350"	775x436	522 - 631	-73 - +508
400"	886x498	598 - 721	-83 - +581
450"	996x560	673 - 812	-93 - +654
458"	1014x570	685 - 827	-95 - +665



Unit: cm

16:10 Screen Size		①	②
		Minimum (Wide) to Maximum (Tele)	Vertical Lens Shift Top to Bottom
57"	123x77	78 - 95	-8 - +84
60"	130x81	82 - 101	-8 - +89
70"	151x94	97 - 118	-9 - +104
80"	172x108	112 - 136	-11 - +118
90"	194x121	127 - 154	-12 - +133
100"	215x135	141 - 171	-13 - +148
120"	258x162	171 - 207	-16 - +178
150"	323x202	215 - 260	-20 - +222
200"	431x269	288 - 348	-27 - +296
250"	538x337	361 - 437	-34 - +370
300"	646x404	435 - 525	-40 - +444
350"	754x471	508 - 613	-47 - +518
400"	862x538	581 - 702	-54 - +592
450"	969x606	655 - 790	-61 - +666
471"	1014x634	685 - 827	-63 - +697

## Rear projection wide lens ELPLR04

Lens shift is not supported.

Unit: cm

4:3 Screen Size		①	②
60"	122x91	84	+46
70"	142x107	100	+53
80"	163x122	115	+61

4:3 Screen Size		①	②
90"	183x137	130	+69
100"	203x152	145	+76
120"	244x183	176	+91
150"	305x229	221	+114
200"	406x305	297	+152
250"	508x381	373	+191
300"	610x457	449	+229
350"	711x533	525	+267
400"	813x610	601	+305
450"	914x686	677	+343
500"	1016x762	753	+381

Unit: cm

16:9 Screen Size		①	②
56"	124x70	86	+35
60"	133x75	93	+37
70"	155x87	109	+44
80"	177x100	126	+50
90"	199x112	142	+56
100"	221x125	159	+62
120"	266x149	192	+75
150"	332x187	242	+93
200"	443x249	324	+125
250"	553x311	407	+156
300"	664x374	490	+187
350"	775x436	573	+218
400"	886x498	656	+249



16:9 Screen Size		①	②
450"	996x560	738	+280
458"	1014x570	752	+285

Unit: cm

16:10 Screen Size		①	②
57"	123x77	85	+38
60"	130x81	90	+40
70"	151x94	106	+47
80"	172x108	122	+54
90"	194x121	138	+61
100"	215x135	154	+67
120"	258x162	187	+81
150"	323x202	235	+101
200"	431x269	315	+135
250"	538x337	396	+168
300"	646x404	477	+202
350"	754x471	557	+236
400"	862x538	638	+269
450"	969x606	718	+303
471"	1014x634	752	+317

## Wide zoom lens ELPLW04

Unit: cm

4:3 Screen Size		①	②
		Minimum (Wide) to Maximum (Tele)	Vertical Lens Shift Top to Bottom
60"	122x91	146 - 201	-5 - +97

4:3 Screen Size		①	②
		Minimum (Wide) to Maximum (Tele)	Vertical Lens Shift Top to Bottom
70"	142x107	171 - 236	-6 - +113
80"	163x122	197 - 270	-7 - +129
90"	183x137	222 - 305	-8 - +145
100"	203x152	248 - 340	-8 - +161
120"	244x183	299 - 409	-10 - +193
150"	305x229	376 - 513	-13 - +241
200"	406x305	504 - 686	-17 - +322
250"	508x381	632 - 860	-21 - +402
300"	610x457	759 - 1033	-25 - +483
350"	711x533	887 - 1207	-30 - +563
400"	813x610	1015 - 1380	-34 - +643
450"	914x686	1143 - 1553	-38 - +724
500"	1016x762	1271 - 1727	-42 - +804

Unit: cm

16:9 Screen Size		①	②
		Minimum (Wide) to Maximum (Tele)	Vertical Lens Shift Top to Bottom
56"	124x70	148 - 204	-17 - +87
60"	133x75	159 - 220	-18 - +93
70"	155x87	187 - 257	-21 - +108
80"	177x100	215 - 295	-24 - +124
90"	199x112	243 - 333	-27 - +139
100"	221x125	271 - 371	-30 - +155
120"	266x149	327 - 446	-36 - +185



16:9 Screen Size		①	②
		Minimum (Wide) to Maximum (Tele)	Vertical Lens Shift Top to Bottom
150"	332x187	410 - 560	-45 - +232
200"	443x249	549 - 748	-60 - +309
250"	553x311	689 - 937	-75 - +386
300"	664x374	828 - 1126	-90 - +464
350"	775x436	967 - 1315	-105 - +541
400"	886x498	1107 - 1504	-120 - +618
450"	996x560	1246 - 1693	-135 - +695
458"	1014x570	1268 - 1723	-137 - +708

16:10 Screen Size		①	②
		Minimum (Wide) to Maximum (Tele)	Vertical Lens Shift Top to Bottom
400"	862x538	1076 - 1463	-90 - +628
450"	969x606	1212 - 1647	-101 - +707
471"	1014x634	1269 - 1724	-106 - +740

Unit: cm

16:10 Screen Size		①	②
		Minimum (Wide) to Maximum (Tele)	Vertical Lens Shift Top to Bottom
57"	123x77	147 - 202	-13 - +90
60"	130x81	155 - 213	-13 - +94
70"	151x94	182 - 250	-16 - +110
80"	172x108	209 - 287	-18 - +126
90"	194x121	236 - 324	-20 - +141
100"	215x135	263 - 360	-22 - +157
120"	258x162	318 - 434	-27 - +188
150"	323x202	399 - 544	-34 - +236
200"	431x269	534 - 728	-45 - +314
250"	538x337	670 - 912	-56 - +393
300"	646x404	805 - 1096	-67 - +471
350"	754x471	941 - 1279	-79 - +550

## Middle throw zoom lens ELPLM06

Unit: cm

4:3 Screen Size		①	②
		Minimum (Wide) to Maximum (Tele)	Vertical Lens Shift Top to Bottom
60"	122x91	299 - 462	-5 - +97
70"	142x107	351 - 541	-6 - +113
80"	163x122	403 - 621	-7 - +129
90"	183x137	455 - 700	-8 - +145
100"	203x152	507 - 779	-8 - +161
120"	244x183	611 - 937	-10 - +193
150"	305x229	767 - 1175	-13 - +241
200"	406x305	1027 - 1571	-17 - +322
250"	508x381	1287 - 1967	-21 - +402
300"	610x457	1547 - 2363	-25 - +483
350"	711x533	1807 - 2759	-30 - +563
400"	813x610	2067 - 3155	-34 - +643
450"	914x686	2327 - 3552	-38 - +724
500"	1016x762	2587 - 3948	-42 - +804



Unit: cm

16:9 Screen Size		①	②
		Minimum (Wide) to Maximum (Tele)	Vertical Lens Shift Top to Bottom
56"	124x70	304 - 470	-17 - +87
60"	133x75	326 - 505	-18 - +93
70"	155x87	383 - 591	-21 - +108
80"	177x100	440 - 677	-24 - +124
90"	199x112	496 - 764	-27 - +139
100"	221x125	553 - 850	-30 - +155
120"	266x149	666 - 1022	-36 - +185
150"	332x187	836 - 1281	-45 - +232
200"	443x249	1120 - 1713	-60 - +309
250"	553x311	1403 - 2144	-75 - +386
300"	664x374	1686 - 2576	-90 - +464
350"	775x436	1969 - 3007	-105 - +541
400"	886x498	2253 - 3439	-120 - +618
450"	996x560	2536 - 3870	-135 - +695
458"	1014x570	2581 - 3939	-137 - +708

Unit: cm

16:10 Screen Size		①	②
		Minimum (Wide) to Maximum (Tele)	Vertical Lens Shift Top to Bottom
57"	123x77	301 - 465	-13 - +90
60"	130x81	317 - 491	-13 - +94
70"	151x94	372 - 575	-16 - +110
80"	172x108	428 - 659	-18 - +126

16:10 Screen Size		①	②
		Minimum (Wide) to Maximum (Tele)	Vertical Lens Shift Top to Bottom
90"	194x121	483 - 743	-20 - +141
100"	215x135	538 - 826	-22 - +157
120"	258x162	648 - 994	-27 - +188
150"	323x202	813 - 1246	-34 - +236
200"	431x269	1089 - 1666	-45 - +314
250"	538x337	1365 - 2086	-56 - +393
300"	646x404	1640 - 2506	-67 - +471
350"	754x471	1916 - 2926	-79 - +550
400"	862x538	2191 - 3346	-90 - +628
450"	969x606	2467 - 3765	-101 - +707
471"	1014x634	2583 - 3942	-106 - +740

## Middle throw zoom lens ELPLM07

Unit: cm

4:3 Screen Size		①	②
		Minimum (Wide) to Maximum (Tele)	Vertical Lens Shift Top to Bottom
60"	122x91	433 - 670	-5 - +97
70"	142x107	509 - 786	-6 - +113
80"	163x122	585 - 901	-7 - +129
90"	183x137	661 - 1017	-8 - +145
100"	203x152	738 - 1133	-8 - +161
120"	244x183	890 - 1364	-10 - +193
150"	305x229	1118 - 1711	-13 - +241
200"	406x305	1499 - 2289	-17 - +322



4:3 Screen Size		①	②
		Minimum (Wide) to Maximum (Tele)	Vertical Lens Shift Top to Bottom
250"	508x381	1880 - 2867	-21 - +402
300"	610x457	2261 - 3445	-25 - +483
350"	711x533	2642 - 4023	-30 - +563
400"	813x610	3023 - 4601	-34 - +643
450"	914x686	3404 - 5180	-38 - +724
500"	1016x762	3784 - 5758	-42 - +804

Unit: cm

16:9 Screen Size		①	②
		Minimum (Wide) to Maximum (Tele)	Vertical Lens Shift Top to Bottom
56"	124x70	441 - 682	-17 - +87
60"	133x75	474 - 732	-18 - +93
70"	155x87	557 - 858	-21 - +108
80"	177x100	640 - 984	-24 - +124
90"	199x112	723 - 1110	-27 - +139
100"	221x125	806 - 1236	-30 - +155
120"	266x149	972 - 1488	-36 - +185
150"	332x187	1221 - 1866	-45 - +232
200"	443x249	1636 - 2496	-60 - +309
250"	553x311	2051 - 3126	-75 - +386
300"	664x374	2465 - 3755	-90 - +464
350"	775x436	2880 - 4385	-105 - +541
400"	886x498	3295 - 5015	-120 - +618
450"	996x560	3710 - 5645	-135 - +695

16:9 Screen Size		①	②
		Minimum (Wide) to Maximum (Tele)	Vertical Lens Shift Top to Bottom
458"	1014x570	3777 - 5746	-137 - +708

Unit: cm

16:10 Screen Size		①	②
		Minimum (Wide) to Maximum (Tele)	Vertical Lens Shift Top to Bottom
57"	123x77	436 - 675	-13 - +90
60"	130x81	460 - 712	-13 - +94
70"	151x94	541 - 834	-16 - +110
80"	172x108	622 - 957	-18 - +126
90"	194x121	703 - 1079	-20 - +141
100"	215x135	783 - 1202	-22 - +157
120"	258x162	945 - 1447	-27 - +188
150"	323x202	1187 - 1815	-34 - +236
200"	431x269	1591 - 2428	-45 - +314
250"	538x337	1994 - 3040	-56 - +393
300"	646x404	2398 - 3653	-67 - +471
350"	754x471	2802 - 4266	-79 - +550
400"	862x538	3206 - 4879	-90 - +628
450"	969x606	3609 - 5492	-101 - +707
471"	1014x634	3779 - 5749	-106 - +740



## Long throw zoom lens ELPLL07

Unit: cm

4:3 Screen Size		①	②
		Minimum (Wide) to Maximum (Tele)	Vertical Lens Shift Top to Bottom
60"	122x91	647 - 918	-5 - +97
70"	142x107	760 - 1077	-6 - +113
80"	163x122	874 - 1235	-7 - +129
90"	183x137	987 - 1393	-8 - +145
100"	203x152	1100 - 1552	-8 - +161
120"	244x183	1326 - 1868	-10 - +193
150"	305x229	1666 - 2343	-13 - +241
200"	406x305	2232 - 3135	-17 - +322
250"	508x381	2799 - 3927	-21 - +402
300"	610x457	3365 - 4719	-25 - +483
350"	711x533	3931 - 5510	-30 - +563
400"	813x610	4497 - 6302	-34 - +643
450"	914x686	5063 - 7094	-38 - +724
500"	1016x762	5630 - 7886	-42 - +804

Unit: cm

16:9 Screen Size		①	②
		Minimum (Wide) to Maximum (Tele)	Vertical Lens Shift Top to Bottom
56"	124x70	658 - 934	-17 - +87
60"	133x75	708 - 1003	-18 - +93
70"	155x87	831 - 1176	-21 - +108
80"	177x100	955 - 1348	-24 - +124

16:9 Screen Size		①	②
		Minimum (Wide) to Maximum (Tele)	Vertical Lens Shift Top to Bottom
90"	199x112	1078 - 1521	-27 - +139
100"	221x125	1201 - 1693	-30 - +155
120"	266x149	1448 - 2038	-36 - +185
150"	332x187	1818 - 2556	-45 - +232
200"	443x249	2435 - 3418	-60 - +309
250"	553x311	3052 - 4281	-75 - +386
300"	664x374	3669 - 5144	-90 - +464
350"	775x436	4286 - 6006	-105 - +541
400"	886x498	4902 - 6869	-120 - +618
450"	996x560	5519 - 7731	-135 - +695
458"	1014x570	5618 - 7869	-137 - +708

Unit: cm

16:10 Screen Size		①	②
		Minimum (Wide) to Maximum (Tele)	Vertical Lens Shift Top to Bottom
57"	123x77	652 - 925	-13 - +90
60"	130x81	688 - 975	-13 - +94
70"	151x94	808 - 1143	-16 - +110
80"	172x108	928 - 1311	-18 - +126
90"	194x121	1048 - 1479	-20 - +141
100"	215x135	1168 - 1647	-22 - +157
120"	258x162	1408 - 1982	-27 - +188
150"	323x202	1768 - 2486	-34 - +236
200"	431x269	2368 - 3325	-45 - +314





16:10 Screen Size		①	②
		Minimum (Wide) to Maximum (Tele)	Vertical Lens Shift Top to Bottom
250"	538x337	2968 - 4164	-56 - +393
300"	646x404	3569 - 5004	-67 - +471
350"	754x471	4169 - 5843	-79 - +550
400"	862x538	4769 - 6682	-90 - +628
450"	969x606	5369 - 7521	-101 - +707
471"	1014x634	5621 - 7874	-106 - +740

## Supported Resolutions

When the resolution resolution of the input signals is larger than the projector's panel resolution, the image quality may decline.

### Computer signals (analog RGB)

Signal	Refresh Rate (Hz)	Resolution (Dots)
VGA	60/72/75/85	640x480
SVGA	56/60/72/75/85	800x600
XGA	60/70/75/85	1024x768
WXGA	60	1280x768
	60	1366x768
	60/75/85	1280x800
WXGA+	60/75/85	1440x900
WXGA++	60	1600x900
SXGA	70/75/85	1152x864
	60/75/85	1280x1024
	60/75/85	1280x960
SXGA+	60/75	1400x1050
WSXGA+*1	60	1680x1050
UXGA	60	1600x1200
WUXGA*2	60	1920x1200
MAC13"	67	640x480
MAC16"	75	832x624
MAC19"	75	1024x768
	59	1024x768

Signal	Refresh Rate (Hz)	Resolution (Dots)
MAC21"	75	1152x870

\*1 Only compatible when Wide is selected as the **Resolution** in the **Configuration** menu. (This is not available for EB-Z11005/EB-Z11000/EB-Z9870.)

\*2 EB-Z10005U/EB-Z10000U/EB-Z9875U/EB-Z9870U/EB-Z9750U only. Only compatible when VESA CVTRB (Reduced Blanking) signals are being input.

Even when signals other than those mentioned above are input, it is likely that the image can be projected. However, not all functions may be supported.

### Component video

Signal	Refresh Rate (Hz)	Resolution (Dots)
SDTV (480i)	60	720x480
SDTV (576i)	50	720x576
SDTV (480p)	60	720x480
SDTV (576p)	50	720x576
HDTV (720p)	50/60	1280x720
HDTV (1080i)	50/60	1920x1080
HDTV (1080p)*	50/60	1920x1080

\* Only for the input signals from the Computer input port.

### Composite video

Signal	Refresh Rate (Hz)	Resolution (Dots)
TV (NTSC)	60	720x480
TV (SECAM)	50	720x576
TV (PAL)	50/60	720x576

### Input Signals from the DVI-D input port, HDMI input port, and HDBaseT port\*1.

Signal	Refresh Rate (Hz)	Resolution (Dots)
VGA	60	640x480
SVGA	60	800x600
XGA	60	1024x768
WXGA	60	1280x800
	60	1366x768
WXGA+	60	1440x900
WXGA++	60	1600x900
WSXGA+*2	60	1680x1050
SXGA	60	1280x960
	60	1280x1024
SXGA+	60	1400x1050
UXGA	60	1600x1200
WUXGA*3	60	1920x1200
SDTV (480i)	60	720x480
SDTV (576i)	50	720x576
SDTV (480p)	60	720x480
SDTV (576p)	50	720x576
HDTV (720p)	50/60	1280x720
HDTV (1080i)	50/60	1920x1080
HDTV (1080p)	24/30/50/60	1920x1080

\*1 When an HDMI connection is made using the optional HDBaseT Transmitter.

\*2 This is not available for EB-Z11005/EB-Z11000/EB-Z9870.

\*3 Only compatible when VESA CVT-RB (Reduced Blanking) signals are being input.

### Input Signals from SDI Input Port (For EB-Z10005U/EB-Z10000U/EB-Z9875U/EB-Z9870U only)

Signal	Refresh Rate (Hz)	Resolution (Dots)	Mode	Color Space	Number of Bits	Level
SDTV (480i)	60	720x480	SD-SDI	YPbPr 4:2:2	10 bits	-
SDTV (576i)	50	720x576				
HDTV (720p)	50/60	1280x720	HD-SDI			
HDTV (1080i)	50i/60i	1920x1080				
HDTV (1080p)	24p/25p/30p	1920x1080				
HDTV (1080p)	50p/60p	1920x1080	3G-SDI			

## Projector General Specifications

<b>Product name</b>	EB-Z10005U EB-Z10000U	EB-Z9875U EB-Z9870U	EB-Z9750U	EB-Z11000W	EB-Z9900W	EB-Z9800W	EB-Z11005 EB-Z11000	EB-Z9870
<b>Dimensions</b>	534 (W) x 197 (H) x 741 (D) mm (not including raised section)							
<b>LCD panel size</b>	1.03" Wide						1.06"	
<b>Display method</b>	Polysilicon TFT active matrix							
<b>Resolution</b>	2,304,000 WUXGA (1920 (W) x 1200 (H) dots) x 3			1,024,000 WXGA (1280 (W) x 800 (H) dots) x 3			786,432 XGA (1024 (W) x 768 (H) dots) x 3	
<b>Focus adjustment</b>	Automatic							
<b>Zoom adjustment*1</b>	Automatic (1-1.61)							
<b>Lens shift*2</b>	Automatic (Maximum vertical direction of approx. 60%, Maximum horizontal direction of approx. 18%)						Automatic (Maximum vertical direction of approx. 56%*3, Maximum horizontal direction of approx. 19%)	
<b>Lamp</b>	<b>Normal</b>	UHE lamp, 380W Model No.: ELPLP81 (one pack)/ELPLP82 (two packs)						
	<b>For portrait use</b>	UHE lamp, 304W Model No.: ELPLP83 (one pack)/ELPLP84 (two packs)						
<b>Power</b>	100 - 240 V AC ±10% 50/60 Hz 11.2 - 4.9 A	100 - 240 V AC ±10% 50/60 Hz 10.0 - 4.4 A	100 - 240 V AC ±10% 50/60 Hz 8.5 - 3.8 A	100 - 240 V AC ±10% 50/60 Hz 11.2 - 4.9V	100 - 240 V AC ±10% 50/60 Hz 10.0 - 4.4A	100 - 240 V AC ±10% 50/60 Hz 8.5 - 3.8A	100 - 240 V AC ±10% 50/60 Hz 11.2 - 4.9A	100 - 240 V AC ±10% 50/60 Hz 8.5 - 3.8A

<b>Power consumption</b>	<b>100 - 120V Area</b>	Operating: 1120 W Standby power consumption (Communication On): 2.7 W Standby power consumption (Communication Off): 0.26 W	Operating: 995 W Standby power consumption (Communication On): 2.7 W Standby power consumption (Communication Off): 0.26 W	Operating: 844 W Standby power consumption (Communication On): 2.7 W Standby power consumption (Communication Off): 0.26 W	Operating: 1120 W Standby power consumption (Communication On): 2.7 W Standby power consumption (Communication Off): 0.26 W	Operating: 995 W Standby power consumption (Communication On): 2.7 W Standby power consumption (Communication Off): 0.26 W	Operating: 844 W Standby power consumption (Communication On): 2.7 W Standby power consumption (Communication Off): 0.26 W	Operating: 1120 W Standby power consumption (Communication On): 2.7 W Standby power consumption (Communication Off): 0.26 W	Operating: 844 W Standby power consumption (Communication On): 2.7 W Standby power consumption (Communication Off): 0.26 W	
	<b>220 - 240V Area</b>	Operating: 1060 W Standby power consumption (Communication On): 2.9 W Standby power consumption (Communication Off): 0.37 W	Operating: 948 W Standby power consumption (Communication On): 2.9 W Standby power consumption (Communication Off): 0.37 W	Operating: 809 W Standby power consumption (Communication On): 2.9 W Standby power consumption (Communication Off): 0.37 W	Operating: 1060 W Standby power consumption (Communication On): 2.9 W Standby power consumption (Communication Off): 0.37 W	Operating: 948 W Standby power consumption (Communication On): 2.9 W Standby power consumption (Communication Off): 0.37 W	Operating: 809 W Standby power consumption (Communication On): 2.9 W Standby power consumption (Communication Off): 0.37 W	Operating: 1060 W Standby power consumption (Communication On): 2.9 W Standby power consumption (Communication Off): 0.37 W	Operating: 809 W Standby power consumption (Communication On): 2.9 W Standby power consumption (Communication Off): 0.37 W	
<b>Operating altitude</b>	Altitude 0 to 3,048 m									
<b>Operating temperature</b>	0 to +50°C*4 (No condensation)									
<b>Storage temperature</b>	-10 to +60°C (No condensation)									
<b>Mass</b>	Approx. 26 kg		Approx. 25 kg		Approx. 26 kg		Approx. 25 kg		Approx. 25 kg	

\*1 The specifications are when a standard zoom lens ELPLS04 is attached.

\*2 The rear short throw zoom lens ELPLR04 does not support lens shift.

\*3 When using a short throw zoom lens ELPLU02, if you move it more than 50%, part of the screen cannot be displayed correctly.

\*4 At an altitude of 0 to 1,499 m, the operating temperature is 0 to +50°C when **Power Consumption** is set to **ECO** or **Temp Interlock**, and 0 to +45°C when it is set to **Normal**.

At an altitude of 1,500 to 3,048 m, the operating temperature is 0 to +45°C when **Power Consumption** is set to **ECO** or **Temp Interlock**, and 0 to +40°C when it is set to **Normal**.

Product name			EB-Z10005U EB-Z10000U	EB-Z9875U EB-Z9870U	EB-Z9750U	EB-Z11000W	EB-Z9900W	EB-Z9800W	EB-Z11005 EB-Z11000	EB-Z9870	
Connectors	Computer input port	1	Mini D-Sub15-pin (female) blue								
	BNC input port	1	5BNC (female)								
	HDMI input port	1	HDMI HDCP compatible								
	S-Video input port	1	Mini DIN 4-pin								
	Video input port	1	1BNC (female)								
	Monitor Out port	1	Mini D-Sub15-pin (female) black								
	DVI-D input port	1	DVI-D 24pin Single link HDCP compatible								
	HDBaseT port	1	RJ-45								
	LAN port	1	RJ-45								
	SDI input port	1	1BNC (female)	-							
	Service port*	1	USB connector (Type B)								
	RS-232C port	1	Mini D-Sub 9-pin (male)								
	Remote port	1	Stereo mini jack (3.5Φ)								
USB port (Only for wireless LAN unit)*	1	USB connector (Type A)									

\* USB 2.0 is supported. However, USB ports are not guaranteed to operate all devices that support USB.

This product is also designed for IT power distribution system with phase-to-phase voltage 230V.

## DECLARATION of CONFORMITY

According to 47CFR, Part 2 and 15

Class B Personal Computers and Peripherals; and/or  
CPU Boards and Power Supplies used with Class B Personal Computers

We: Epson America, Inc.  
Located at: 3840 Kilroy Airport Way  
MS: 3-13  
Long Beach, CA 90806  
Tel: 562-981-3840

Declare under sole responsibility that the product identified herein, complies with 47CFR Part 2 and 15 of the FCC rules as a Class B digital device. Each product marketed, is identical to the representative unit tested and found to be compliant with the standards. Records maintained continue to reflect the equipment being produced can be expected to be within the variation accepted, due to quantity production and testing on a statistical basis as required by 47CFR 2.909. Operation is subject to the following two conditions : (1) this device may not cause harmful interference, and (2) this device must accept any interference received, including interference that may cause undesired operation.

Trade Name: EPSON  
Type of Product: LCD Projector  
Model: H606C/H607C/H608C/H609C/H610C/H611C/  
H615C/H616C

## FCC Compliance Statement For United States Users

This equipment has been tested and found to comply with the limits for a Class B digital device, pursuant to Part 15 of the FCC Rules. These limits are designed to provide reasonable protection against harmful interference in a residential installation. This equipment generates, uses, and can radiate radio frequency energy and, if not installed and used in accordance with the instructions, may cause harmful interference to radio communications. However, there is no guarantee that interference will not occur in a particular installation. If this equipment does cause interference to radio and television reception, which can be determined by turning the equipment off and on, the user is encouraged to try to correct the interference by one or more of the following measures.

- Reorient or relocate the receiving antenna.
- Increase the separation between the equipment and receiver.
- Connect the equipment into an outlet on a circuit different from that to which the receiver is connected.
- Consult the dealer or an experienced radio/TV technician for help.

### WARNING

The connection of a non-shielded equipment interface cable to this equipment will invalidate the FCC Certification or Declaration of this device and may cause interference levels which exceed the limits established by the FCC for this equipment. It is the responsibility of the user to obtain and use a shielded equipment interface cable with this device. If this equipment has more than one interface connector, do not leave cables connected to unused interfaces. Changes or modifications not expressly approved by the manufacturer could void the user's authority to operate the equipment.

## FCC Statement for Verification

This device complies with Part 15 of the FCC Rules. Operation is subject to the following two conditions:(1) this device may not cause harmful interference, and (2) this device must accept any interference received, including interference that may cause undesired operation.



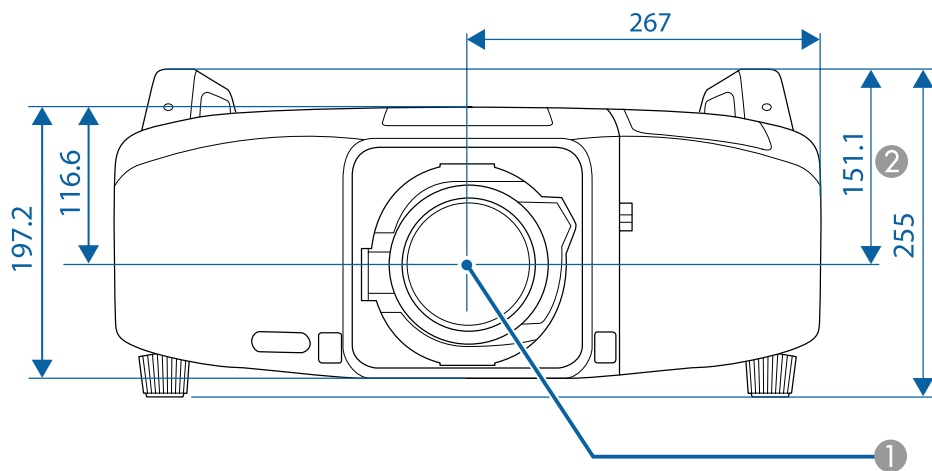

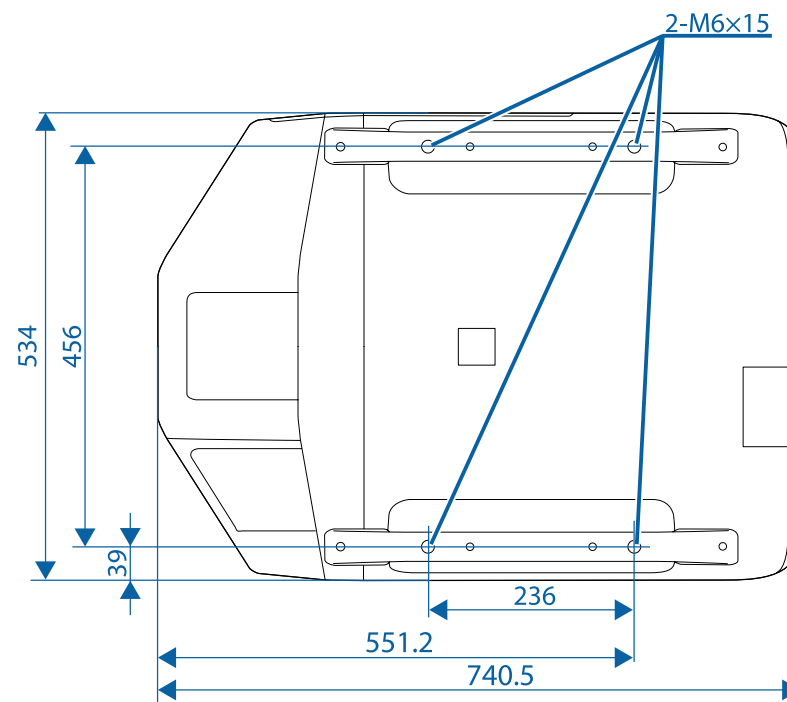

- ① Center of lens
- ② Distance from center of lens to suspension bracket fixing point



Units: mm

This section briefly explains the difficult terms that are not explained in the text of this guide. For details, refer to other commercially available publications.

<b>Ad hoc mode</b>	A method of wireless LAN connection that communicates with wireless LAN clients without using an access point.
<b>AMX Device Discovery</b>	AMX Device Discovery is a technology developed by AMX to facilitate AMX control systems for easy operation of the target equipment. Epson have implemented this protocol technology, and have provided a setting to enable the protocol function (ON). See the AMX Web site for more details. URL <a href="http://www.amx.com/">http://www.amx.com/</a>
<b>Aspect Ratio</b>	The ratio between an image's length and its height. Screens with a horizontal:vertical ratio of 16:9, such as HDTV screens, are known as wide screens. SDTV and general computer displays have an aspect ratio of 4:3.
<b>Component video</b>	A method that separates the image signal into a luminance component (Y), and a blue minus luminance (Cb or Pb) and a red minus luminance (Cr or Pr).
<b>Composite video</b>	A method that combines the image signal into a luminance component and a color component for transmission down a single cable.
<b>Contrast</b>	The relative brightness of the light and dark areas of an image can be increased or decreased to make text and graphics stand out more clearly, or to make them appear softer. Adjusting this particular property of an image is called contrast adjustment.
<b>DHCP</b>	An abbreviation of Dynamic Host Configuration Protocol, this protocol automatically assigns an <a href="#">IP address</a> to equipment connected to a network.
<b>DICOM</b>	An acronym for Digital Imaging and Communications in Medicine. An international standard that defines image standards and a communications protocol for medical images.
<b>Gateway Address</b>	This is a server (router) for communicating across a network (subnet) divided according to <a href="#">subnet mask</a> .
<b>HDBaseT</b>	The connection standard for consumer electronics determined by the HDBaseT Alliance. Communicates various control signals such as uncompressed HD video, audio and 100BASE-TX Ethernet using a LAN cable.
<b>HDCP</b>	HDCP is an abbreviation for High-bandwidth Digital Content Protection. It is used to prevent illegal copying and protect copyrights by encrypting digital signals sent over DVI and HDMI ports. Because the HDMI port on this projector supports HDCP, it can project digital images protected by HDCP technology. However, the projector may not be able to project images protected with updated or revised versions of HDCP encryption.
<b>HDTV</b>	An abbreviation for High-Definition Television that refers to high-definition systems which satisfy the following conditions. <ul style="list-style-type: none"> <li>• Vertical resolution of 720p or 1080i or greater (p = <a href="#">Progressive</a>, i = <a href="#">Interlace</a>)</li> <li>• Screen <a href="#">aspect ratio</a> of 16:9</li> </ul>
<b>Infrastructure mode</b>	A method for wireless LAN connection in which devices communicate through access points.
<b>Interlace</b>	Transmits information needed to create one screen by sending every other line, starting from the top of the image and working down to the bottom. Images are more likely to flicker because one frame is displayed every other line.
<b>IP Address</b>	A number to identify a computer connected to a network.

<b>Progressive</b>	Projects information to create one screen at a time, displaying the image for one frame. Even though the number of scan lines is the same, the amount of flicker in images decreases because the volume of information has doubled compared with an interlace system.
<b>Refresh Rate</b>	The light-emitting element of a display maintains the same luminosity and color for an extremely short time. Because of this, the image must be scanned many times per second to refresh the light-emitting element. The number of refresh operations per second is called the Refresh rate and is expressed in hertz (Hz).
<b>SDI</b>	An abbreviation for Serial Digital Interface. The projector is compatible with SD-SDI (Standard Definition), HD-SDI (High Definition), and 3G-SDI (3G Definition) methods.
<b>SDTV</b>	An abbreviation for Standard Definition Television that refers to standard television systems which do not satisfy the conditions for <a href="#">HDTV</a>  High-Definition Television.
<b>SNMP</b>	An abbreviation for Simple Network Management Protocol, which is the protocol for monitoring and controlling devices such as routers and computers connected to a TCP/IP network.
<b>sRGB</b>	An international standard for color intervals that was formulated so that colors that are reproduced by video equipment can be handled easily by computer operating systems (OS) and the Internet. If the connected source has an sRGB mode, set both the projector and the connected signal source to sRGB.
<b>SSID</b>	SSID is identification data for connecting to another device on a wireless LAN. Wireless communication is possible between devices with the same SSID.
<b>Subnet Mask</b>	This is a numerical value that defines the number of bits used for the network address on a divided network (subnet) from the IP address.
<b>Sync.</b>	The signals output from computers have a specific frequency. If the projector frequency does not match this frequency, the resulting images are not of a good quality. The process of matching the phases of these signals (the relative position of the crests and the troughs in the signal) is called Synchronization. If the signals are not synchronized, flickering, blurriness, and horizontal interference occur.
<b>Tracking</b>	The signals output from computers have a specific frequency. If the projector frequency does not match this frequency, the resulting images are not of a good quality. The process of matching the frequency of these signals (the number of crests in the signal) is called Tracking. If Tracking is not carried out correctly, wide vertical stripes appear in the signal.
<b>Trap IP Address</b>	This is the <a href="#">IP address</a>  for the destination computer used for error notification in SNMP.

All rights reserved. No part of this publication may be reproduced, stored in a retrieval system, or transmitted in any form or by any means, electronic, mechanical, photocopying, recording, or otherwise, without the prior written permission of Seiko Epson Corporation. No patent liability is assumed with respect to the use of the information contained herein. Neither is any liability assumed for damages resulting from the use of the information contained herein.

Neither Seiko Epson Corporation nor its affiliates shall be liable to the purchaser of this product or third parties for damages, losses, costs, or expenses incurred by the purchaser or third parties as a result of: accident, misuse, or abuse of this product or unauthorized modifications, repairs, or alterations to this product, or (excluding the U.S.) failure to strictly comply with Seiko Epson Corporation's operating and maintenance instructions.

Seiko Epson Corporation shall not be liable against any damages or problems arising from the use of any options or any consumable products other than those designated as Original Epson Products or Epson Approved Products by Seiko Epson Corporation.

The contents of this guide may be changed or updated without further notice.

Illustrations in this guide and the actual projector may differ.

## Restriction of Use

When this product is used for applications requiring high reliability/safety such as transportation devices related to aviation, rail, marine, automotive etc.; disaster prevention devices; various safety devices etc; or functional/precision devices etc, you should use this product only after giving consideration to including fail-safes and redundancies into your design to maintain safety and total system reliability. Because this product was not intended for use in applications requiring extremely high reliability/safety such as aerospace equipment, main communication equipment, nuclear power control equipment, or medical equipment related to direct medical care etc, please make your own judgment on this product's suitability after a full evaluation.

## About Notations

Microsoft® Windows® 2000 operating system  
Microsoft® Windows® XP operating system  
Microsoft® Windows Vista® operating system  
Microsoft® Windows® 7 operating system  
Microsoft® Windows® 8 operating system  
Microsoft® Windows® 8.1 operating system

In this guide, the operating systems above are referred to as "Windows 2000", "Windows XP", "Windows Vista", "Windows 7", "Windows 8", and "Windows 8.1". Furthermore, the collective term Windows may be used to refer to Windows 2000, Windows XP, Windows Vista, Windows 7, Windows 8, and Windows 8.1, and multiple versions of Windows may be referred to as, for example, Windows 2000/XP/Vista/7/8/8.1, with the Windows notation omitted.

Mac OS X 10.3.x  
Mac OS X 10.4.x  
Mac OS X 10.5.x  
Mac OS X 10.6.x  
OS X 10.7.x  
OS X 10.8.x  
OS X 10.9.x

In this guide, the operating systems above are referred to as "Mac OS X 10.3.x", "Mac OS X 10.4.x", "Mac OS X 10.5.x", "Mac OS X 10.6.x", "OS X 10.7.x", "OS X 10.8.x", and "OS X 10.9.x". Furthermore, the collective term "OS X" is used to refer to them all.

---

## Trademarks and Copyrights

EPSON and ELPLP are trademarks or registered trademarks of the SEIKO EPSON CORPORATION.

Mac and OSX are trademarks of Apple Inc.

Microsoft, Windows, Windows Vista, PowerPoint, and Windows logo are trademarks or registered trademarks of Microsoft Corporation in the United States and/or other countries.

WPA™ and WPA2™ are registered trademarks of Wi-Fi Alliance.

HDMI and High-Definition Multimedia Interface are the trademarks or registered trademarks of HDMI Licensing LLC. 

PJLink is a trademark or registered trademark in Japan, the United States and/or other countries and areas.

HDBaseT™ and the HDBaseT Alliance logo are trademarks of the HDBaseT Alliance.

Other product names used herein are for identification purposes only and may be trademarks of their respective owners. Epson disclaims any and all rights in those marks.

Crestron and Crestron RoomView are registered trademarks of Crestron Electronics, Inc.

Extron® and XTP® are registered trademarks of Extron Electronics.

**3**

- 3D Images ..... 78
- 3D Setup ..... 119

**A**

- A/V Settings ..... 125
- Advanced ..... 118, 124
- Air Exhaust Vent ..... 15
- Air Filter Notice ..... 123
- Air Filter Replacement Period ..... 179
- Air Intake Vent ..... 14
- Aspect ..... 72, 120
- Auto ..... 18
- Auto Iris ..... 71, 118
- Auto Power On ..... 124
- Auto Setup ..... 119

**B**

- Basic Menu ..... 129
- Batch Setup Function ..... 49
- Beep ..... 124
- Black Level ..... 126
- BNC Input Port ..... 16
- BNC Sync Termination ..... 124
- Brightness ..... 76, 117
- Brightness Level ..... 126

**C**

- Cable Holder ..... 17
- Cable Wiring Slot ..... 14
- Ceiling Mount Fixing Points ..... 15
- Change Input ..... 18

- Channel ..... 130
- Cleaning ..... 172
- Cleaning the Air Filter ..... 172
- Cleaning the Projector's Surface ..... 172
- Color Matching ..... 126
- Color Mode ..... 70, 117, 126
- Color Saturation ..... 117
- Color Temp. .... 118
- Color Uniformity ..... 123, 126, 183
- Computer Input Port ..... 17
- Configuration Menu ..... 114
- Connection Mode ..... 130
- Consumables ..... 199
- Contrast ..... 117
- Control Panel ..... 15, 18
- Control Panel Lock ..... 110, 121
- Corner Wall ..... 67, 121
- Crestron RoomView ..... 193
- Curved Surface ..... 63, 121

**D**

- Date & Time ..... 100, 125
- DICOM SIM ..... 70
- Direct Power On ..... 124
- Direction ..... 30, 123
- Display ..... 123
- Display Background ..... 123
- Distance ..... 200
- Document Camera ..... 198
- DVI-D Port ..... 17
- Dynamic ..... 70

**E**

- EasyMP Monitor ..... 186
- Edge Blending ..... 81, 126
- Email Address ..... 134
- Esc ..... 19
- ESC/VP21 ..... 191
- Event ID ..... 137, 170
- Extended Menu ..... 122
- E-Zoom ..... 95

**F**

- Filter Indicator ..... 141, 172
- Focus ..... 19, 37
- Frame Interpolation ..... 78, 119
- Freeze ..... 95
- Front ..... 123
- Front Feet ..... 14, 16
- Full Lock ..... 110

**G**

- Gamma ..... 76
- Gateway Address ..... 131, 133
- Geometric Correction ..... 121

**H**

- H/V-Keystone ..... 61, 121
- Handles ..... 14
- HDBaseT ..... 125
- HDBaseT port ..... 18
- HDBaseT Signal Quality ..... 137
- HDMI Input Port ..... 17
- Help ..... 140

- High Altitude Mode ..... 124
  - How to Replace the Air Filter ..... 179
  - How to Replace the Lamp ..... 176
  - Hue ..... 76
- I**
- Image Menu ..... 117
  - Image Processing ..... 120
  - Indicators ..... 124
  - Info Menu ..... 136
  - Input Signal ..... 120, 136
  - Instant Off ..... 125
  - Interface Cover ..... 14, 28
  - Interface Cover Removal Button ..... 14
  - Interface Cover Removal Switch ..... 14
  - IP Address ..... 131, 134
  - IP Settings ..... 131, 133
- L**
- Lamp Cover ..... 15
  - Lamp Cover Open Lever ..... 15
  - Lamp Hours ..... 137
  - Lamp Indicator ..... 141
  - Lamp Relay Mode ..... 102
  - Lamp Replacement Period ..... 175
  - Lamp Select ..... 126
  - Lamp Status ..... 137
  - LAN Port ..... 18
  - Language ..... 126
  - Lens Operation Lock ..... 111, 121
  - Lens Replacement Cover ..... 14, 26
  - Lens Shift ..... 19, 35
  - Lens Type ..... 125
- M**
- Mail Menu ..... 134
  - Mail Notification ..... 134, 187
  - Memory ..... 98, 122
  - Menu ..... 19
  - Menu Position ..... 123
  - Message Broadcasting ..... 186
  - Message Position ..... 123
  - Messages ..... 123
  - Monitor displays ..... 218
  - Monitor Out Port ..... 17
  - Mosquito NR ..... 120
  - Multi-Projection ..... 70, 126
  - Multi-Projection function ..... 80
- N**
- Network Configuration ..... 127
  - Network Information ..... 127
  - Network Menu ..... 127
  - Noise Reduction ..... 120
- O**
- Operating Temperature ..... 221
  - Operation ..... 124, 125
  - Optional Accessories ..... 198
  - Overheating ..... 143
  - Overscan ..... 120
- P**
- Panel Alignment ..... 123, 181
  - Part Names and Functions ..... 14
  - Passphrase ..... 132
- Password Protection** ..... 107
- Photo** ..... 70
- PJLink** ..... 192
- PJLink Password** ..... 129
- Point Correction** ..... 65, 121
- Polarizer** ..... 198
- Port Number** ..... 134
- Position** ..... 119
- Power Consumption** ..... 121
- Power Indicator** ..... 141
- Power Inlet** ..... 17
- Power on Protection** ..... 107
- Presentation** ..... 70
- Problem Solving** ..... 160
- Progressive** ..... 119
- Projection** ..... 31, 123
- Projection Distances** ..... 200
- Projection Lens** ..... 14, 26
- Projector ID** ..... 39, 126
- Projector Keyword** ..... 129
- Projector Name** ..... 129
- Q**
- Quick Corner ..... 62, 121
  - Quick Wireless Connection USB Key .... 198
- R**
- Reading Error Notification Emails ..... 188
  - Rear ..... 123
  - Rear Feet ..... 15, 16
  - Refresh Rate ..... 136
  - Remote Control ..... 20
  - Remote Control Button Lock ..... 111

- Remote Control ID ..... 40  
 Remote Control Type ..... 124  
 Remote Port ..... 17  
 Remote Receiver ..... 14, 15, 122  
 Replacing the Remote Control Batteries  
 ..... 23  
 Reset All ..... 138  
 Reset Memory ..... 138  
 Reset Menu ..... 136, 138  
 Resetting the lamp hours ..... 179  
 Resolution ..... 119, 136  
 RGBCMY ..... 126  
 RoomView ..... 194  
 RS-232C Port ..... 17
- S**
- Saturation ..... 76  
 Scale ..... 120, 126  
 Scaled Images ..... 89  
 Schedule ..... 100, 101  
 Schedule Settings ..... 126  
 Screen ..... 123  
 Screen Settings ..... 32  
 Screen Size ..... 92, 200  
 SDI Input Port ..... 16  
 Search ..... 58  
 Search Access Point ..... 131  
 Security ..... 132  
 Security Menu ..... 132  
 Security Slot ..... 14  
 Selecting the Lamp ..... 31  
 Serial Number ..... 137  
 Service Port ..... 17
- Settings Menu ..... 121  
 Sharpness ..... 118  
 Shutter ..... 19, 94  
 Shutter Button ..... 124  
 Shutter Release ..... 124  
 Shutter Timer ..... 124  
 Signal Menu ..... 119  
 Sleep Mode ..... 124  
 Sleep Mode Timer ..... 124  
 SMTP Server ..... 134  
 SNMP ..... 189  
 Soft Keyboard ..... 128  
 Source ..... 91, 136  
 Specifications ..... 220  
 Split Screen ..... 91, 121  
 Split Screen Setup ..... 91  
 Sports ..... 70  
 sRGB ..... 70  
 SSID ..... 130  
 SSID Auto Setting ..... 130  
 SSID Display ..... 131  
 Standby Confirmation ..... 123  
 Standby Mode ..... 125  
 Startup Screen ..... 123  
 Startup Source Search ..... 124  
 Status ..... 137  
 Status Indicator ..... 141  
 Status Indicators ..... 15  
 Status Monitor ..... 19, 150  
 Storage Temperature ..... 221  
 Subnet Mask ..... 131, 133  
 Super-resolution ..... 120  
 Supported Monitor Displays ..... 218  
 S-Video Input Port ..... 17
- Swap Screens ..... 92  
 Sync Info ..... 137  
 Sync. .... 119
- T**
- Target Scope ..... 96  
 Test Pattern ..... 19, 34, 122  
 Theatre ..... 70  
 Tint ..... 118  
 Tracking ..... 119
- U**
- Upside Down ..... 123  
 User Button ..... 122  
 User's Logo ..... 96, 123  
 User's Logo Protection ..... 107
- V**
- Video Input Port ..... 16  
 Video Range ..... 120  
 Video Signal ..... 120, 136
- W**
- Web Browser ..... 186  
 Web Control ..... 187  
 Web Control Password ..... 129  
 Web Remote ..... 189  
 Wired LAN Menu ..... 133  
 Wireless LAN Menu ..... 130  
 Wireless LAN Power ..... 130  
 Wireless LAN Unit ..... 47, 198  
 Wireless LAN Unit Port ..... 17





*Z*

Zoom ..... 19, 37