

# 42" LED-TV

C42110DVB-LED

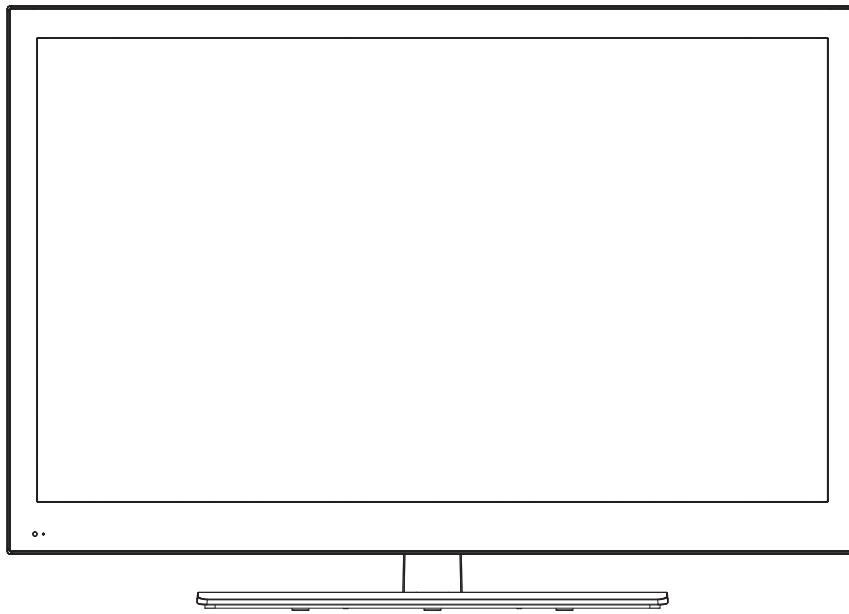

## User Guide

---

# Contents

<b>SAFETY INFORMATION .....</b>	<b>3</b>
Headphone Warning .....	4
Where to install .....	4
LED Screen .....	4
<b>Unit and Accessories .....</b>	<b>5</b>
<b>Getting Started.....</b>	<b>5</b>
Front view.....	5
<b>Remote Control .....</b>	<b>6</b>
Functions of remote control buttons.....	7
To Set the Multi-Satellite Mode button.....	8
Installing Batteries in the Remote Control .....	9
Using the Remote Control .....	9
<b>Aerial connection .....</b>	<b>9</b>
Connecting the TV Antenna .....	9
<b>Connecting external devices .....</b>	<b>9</b>
HDMI Lead.....	9
SCART Lead.....	9
VGA Cable .....	9
<b>CONNECTIONS .....</b>	<b>10</b>
PC connection.....	11
VGA, HDMI PC Connection.....	11
Connecting Video camera and Video recorder .....	11
Connecting an audio system .....	12
Connecting a DVD player.....	12
<b>Common Interface Slot.....</b>	<b>13</b>
USING YOUR COMMON INTERFACE SLOT .....	13
<b>Auto installation setup .....</b>	<b>13</b>
Power On / Off the LED TV.....	13
<b>Source Menu .....</b>	<b>14</b>
<b>Menu Settings .....</b>	<b>14</b>
TV SETTINGS MENU.....	14
PICTURE MENU .....	14
SOUND MENU.....	14
EXTRAS MENU.....	15
OPTIONS MENU.....	15
LOCK MENU.....	15
TV Settings Menu .....	15
Picture Menu .....	16
Sound Menu .....	17
Extras Menu.....	17
Options Menu.....	17
Lock Menu .....	17

---

<b>Multimedia Operation</b> .....	<b>18</b>
Photo .....	19
Music .....	19
Movie .....	20
Text.....	20
<b>Recording Operation</b> .....	<b>21</b>
Recording.....	21
<b>TROUBLE SHOOTING GUIDE</b> .....	<b>23</b>
<b>TECHNICAL SPECIFICATIONS</b> .....	<b>23</b>
TV Specifications .....	23
<b>Wall Mounting</b> .....	<b>24</b>
<b>Waste Electrical Recycling</b> .....	<b>24</b>
Correct disposal of Product.....	24

---

## Introduction

Thank you for purchasing this LED TV which has been designed and manufactured to give you many years of trouble free service.

You may already be familiar with using a similar product but please take time to read these instructions which have been written to ensure you get the very best from your purchase.

## HDMI

HDMI (High Definition Multimedia Interface) is the next generation of digital interface. Unlike conventional connections, it transmits uncompressed digital and audio signals using a single cable. This TV supports high-definition video input via the HDMI socket on the back of the TV.

## Safety is important

To ensure your safety and the safety of others, please read the safety precautions BEFORE you operate this product.

## Disclaimer

The illustrations of the LED-TV, accessories and menus shown in this User's Manual may differ from the actual product.

## SAFETY INFORMATION

IMPORTANT SAFETY INSTRUCTIONS - READ CAREFULLY BEFORE USE.

Take note of the following safety information which appears on the back of the TV.



CAUTION: TO PREVENT ELECTRICAL SHOCK, DO NOT REMOVE ANY COVER SCREWS, NO USER SERVICEABLE PARTS INSIDE, REFER SERVICING TO QUALIFIED SERVICE PERSONNEL.



This symbol indicates that there are important operating maintenance instructions in the literature accompanying this unit.



This symbol indicates that dangerous voltage constituting a risk of electric shock is present within this unit.

Keep these instructions

- Do not use this TV near water.
- Clean only with a slightly damp cloth.
- Do not block any ventilation openings.
- Install in accordance with the supplied Quick Start Guide and this User Guide.
- Protect the power chord from being walked on or pinched, particularly at plugs, and the point where it exits from the TV.
- Do not allow the power chord to overhang the edge of a table.
- Unplug this TV during lightening storms or when unused for long periods of time.



WARNING! TO REDUCE THE RISK OF FIRE OR ELECTRICAL SHOCK, DO NOT EXPOSE THIS TV TO RAIN OR MOISTURE. THE TV MUST NOT BE EXPOSED TO DRIPPING AND SPLASHING AND NO OBJECTS FILLED WITH LIQUIDS SHOULD BE PLACED ON THE TV.

NOTE: No naked flames such as candles should be placed on the TV.

NOTE: When displaying the same still picture for more than 2 hours without any interruption, the picture contours of the continuously displayed contents may remain visible on screen, i.e. a persistent image remains. The same applies, when displaying for more than 2 hours:

- the same background/wallpaper
- logos, video games, computer images, Teletext
- contents with a non-filling aspect ratio (e.g. 4:3 format)

These do not represent any malfunction and will not be covered by the manufacturer's warranty

This unit has been produced according to all current safety regulations. The following safety tips should safeguard users against careless use and the dangers connected with such use.

- Although this appliance has been carefully manufactured and rigorously checked prior leaving the factory, as with all electrical appliances it is possible for problems to develop. If you notice smoke, an excessive build up of heat or any other unexpected phenomena, you should disconnect the plug from the mains power socket immediately.
- Ensure that the unit is sufficiently ventilated! Never place next to or underneath curtains!
- The mains plug or appliance coupler is used as the disconnect device, the disconnect device shall remain readily operable.
- This set should only be connected to a mains power supply which matches that stated on the label on the rear of the TV - do not attempt to connect it to any other type of supply.
- The socket - outlet must be installed near the equipment and easily accessible.
- To prevent overload, don't share the same mains supply socket with too many other items of equipment.
- Apparatus with Class 1 construction shall be connected to a mains socket outlet with a protective earth connection.
- Keep away from rodents. Rodents enjoy biting into electric flexes.
- Always hold the plug when pulling out the plug from the mains supply socket. Do not pull on the flex, the flex can become overloaded and cause a short circuit.
- Set up the unit so that no one is able to trip over the flex.
- Do not place heavy items on the flex, which may damage it.
- Take note that the flex cannot be reached and pulled by young children, avoiding injury.
- Do not set up the unit near to heat sources. The casing and the flex could be damaged by the impact of heat.
- The screen is made of plastic and can break if damage is done to it. Be careful when collecting sharp edged plastic splinters to avoid injury.
- Avoid placing the unit on any surfaces that may be subject to vibrations or shocks.
- To protect the unit during a thunderstorm unplug the AC power cable and disconnect the aerial. Caution: Do not touch the aerial (RF) connector.
- When you leave your home for long periods of time, unplug the AC power cable for safety reasons.
- The unit becomes warm when in operation. Do not place any covers or blankets on the unit in order to prevent overheating. The ventilation holes are not to be blocked. Do not set up near radiators. Do not place in direct sunshine. When placing on a shelf leave 5 cm (2") free space around the whole unit.
- Do not allow water or moisture to enter the TV. Do NOT use in wet or moist areas such as Bathrooms,

steamy kitchens or near swimming pools.

- Do not use this unit when moisture condensation may occur
- Any repairs must be carried out by qualified personnel only.
- Do not open this unit. A non-expert attempting to repair the unit could be dangerous and potentially cause a fire hazard.
- Liquids spilt into the unit can cause serious damage. Switch the set OFF and disconnect the mains power supply, then consult a qualified service person before attempting to use the unit again.
- Do NOT remove the safety covers. There are no useable or serviceable parts inside. You may invalidate the warranty. Qualified personnel must only service this apparatus.
- Do NOT tap or shake the screen, you may damage the internal circuits. Take good care of the remote control, do not drop.
- Never place hot objects or open flame sources on or close to the TV.
- High temperatures can melt plastic and lead to fires.
- To clean the TV use a soft dry cloth. Do NOT use solvents or petrol based fluids. For stubborn stains, you may use a damp cloth with dilute detergent.

### Headphone Warning



Loud music can damage your hearing irreversibly, therefore do not set the volume to a high level when listening through headphones, particularly for lengthy listening periods.

### Where to install

Locate the television away from direct sunlight and strong lights, soft indirect lighting is recommended for comfortable viewing. Use curtains or blinds to prevent direct sunlight falling on the screen. Place the TV on a sturdy platform of which the surface should be flat and steady. This will prevent it from falling over. Make sure the television is located in a position where it cannot be pushed or hit by objects, as pressure will break or damage the screen, and so that small objects cannot be inserted into the ventilation slots or openings in the cabinet.

### LED Screen

The LED display panels are manufactured using an extremely high level of precision technology, however sometimes some parts of the screen may be missing picture elements or have luminous spots. This is not a sign of malfunction.

## Unit and Accessories

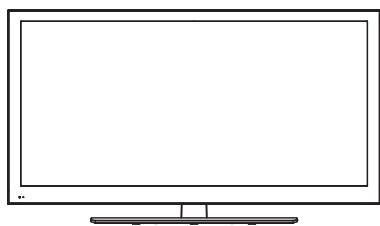

TV set



Remote Control



Batteries  
for Remote  
Control

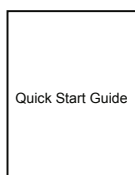

Quick Start Guide

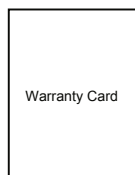

Warranty Card

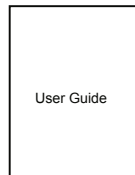

User Guide

## Getting Started

### Front view

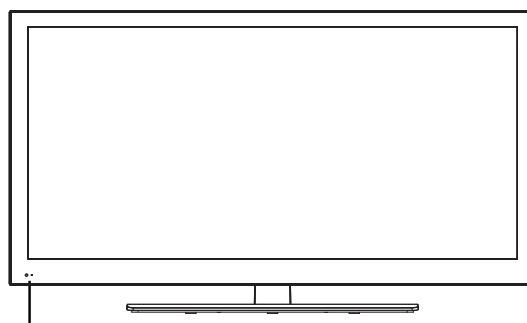

LED Indicator

Remote Control Window

Keep clear

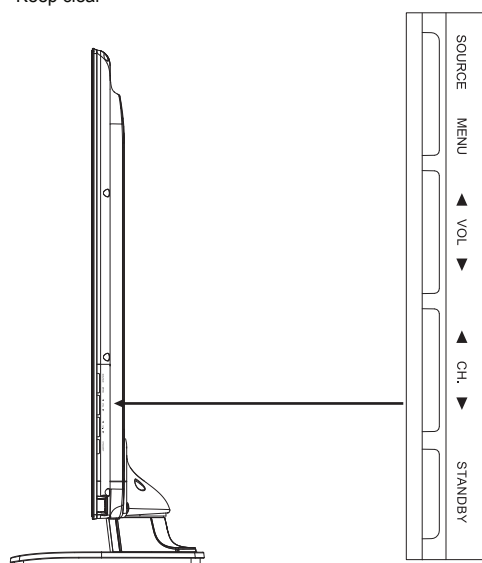

### The functions of the TV buttons are described below.

**Source** : Press to display the input source menu.

**Menu** : Press to display the OSD menu, press again to exit the menu.

**Vol +/-** : Press to adjust the volume.

**CH. +/-** : Press to skip through the channels.

**Standby** : Power switch.



Packaging materials are not toys. Please keep away from children. Plastic bags can cause suffocation when pulled over the head.

# Remote control

Dependant on the Model of the TV some keys will have no function

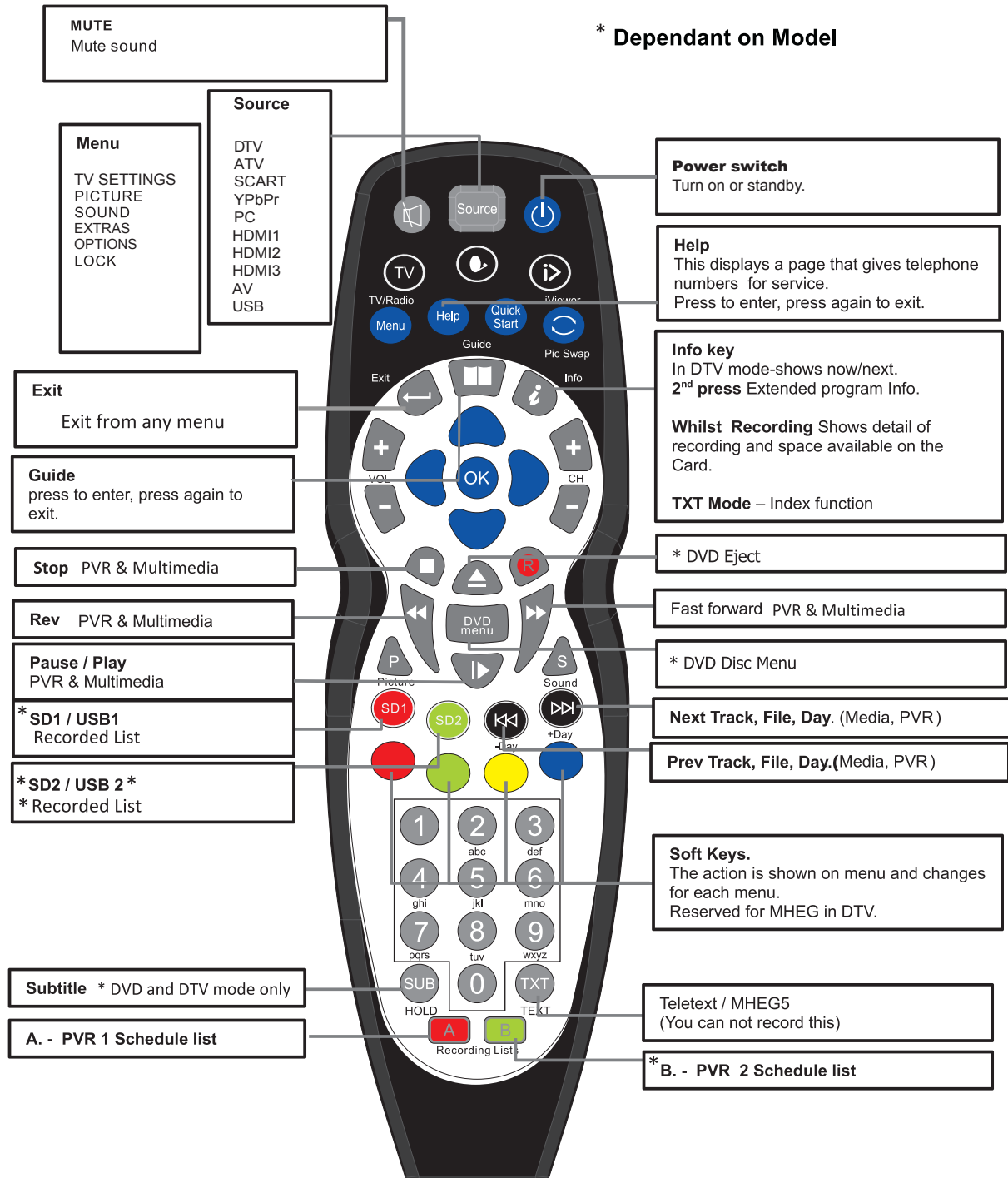

## Remote control (continued)

- **Functions of remote control buttons**

Dependant on the model of the TV some keys will have no function

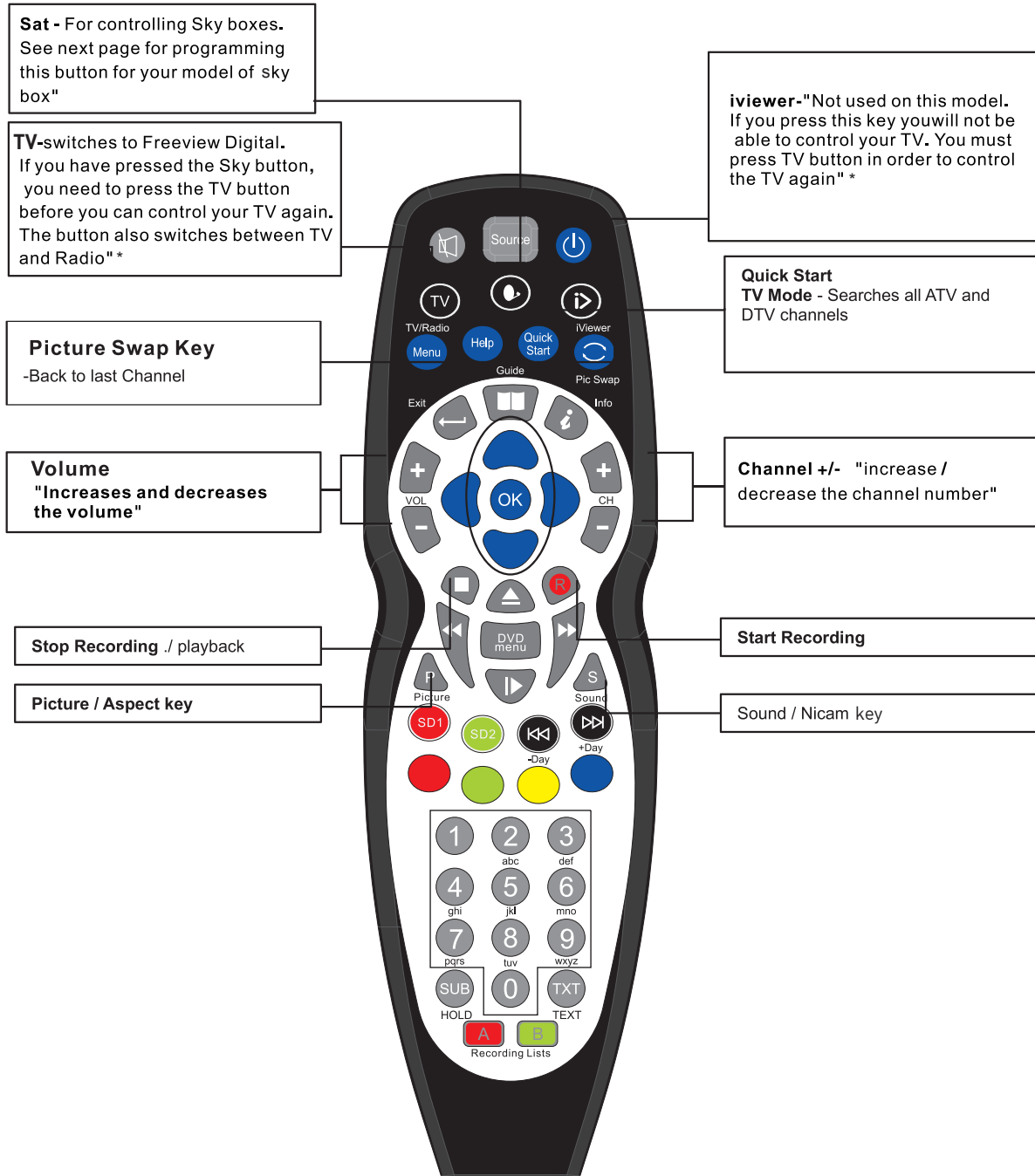

\*Dependant on Model



## Remote control (continued)

Dependant on the model of TV some keys will have no function

\*Dependant on Model



**TV** This button puts the Remote in TV control mode

**Sat** This button puts the Remote in a Multi Satellite control mode  
\* A number of modes are available. See below for details

**i>** This button puts the Remote into an Internet Player mode  
\*This is only used on some TVs and Digital Boxes

### To Set the Multi-Satellite Mode button

The Sat button  is programmable in the remote and can be set as follows:



To set the button if you have no Satellite Receiver:  
Press  and at the same time press 0

If you have a Satellite Receiver with Recorder (Known as "Plus" type)  
Press  and at the same time press 1

If you have a Satellite Receiver with High Definition (Known as "HD" type)  
Press  and at the same time press 2

If you have a normal Digital Satellite Receiver (Known as "Digital" type)  
Press  and at the same time press 3

If you want to use this button to switch on the DVD Player  
Press  and at the same time press 4  
DVD Player only fitted on certain models.

- |   |                       |
|---|-----------------------|
|  | + 0 ~ NO SAT RECEIVER |
|  | + 1 ~ SAT +           |
|  | + 2 ~ SAT HD          |
|  | + 3 ~ SAT DIGITAL     |
|  | + 4 ~ DVD             |

## Installing Batteries in the Remote Control

1. Remove the battery compartment cover at the rear of the remote control by pushing the retaining clip forward and pulling up.
2. Install the supplied batteries, ensuring the polarity matches what is shown in the battery compartment.
3. Replace the battery compartment cover.

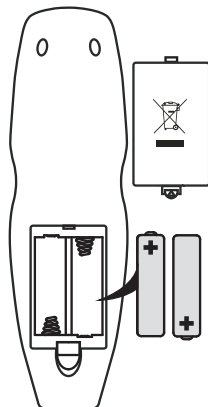

## Using the Remote Control

To use the remote control point it at the TV and press the required buttons. You must be within 6 meters and at an angle of less than 30 degrees from the center of the TV.

**NOTE:** Sunshine or other strong light sources may interfere with the signal from the remote control. In this situation turn the TV away from the light source.



**WARNING! DO NOT LEAVE BATTERIES IN THE REMOTE CONTROL FOR EXTENDED PERIODS AS THEY CAN LEAK OR CORRODE CAUSING DAMAGE TO THE REMOTE CONTROL. CHECK THEM PERIODICALLY AND REPLACE THEM AS REQUIRED.**



**WARNING! DO NOT MIX BATTERY TYPES. WHEN INSERTING BATTERIES, REPLACE ALL BATTERIES AT THE SAME TIME. DO NOT MIX OLD AND NEW BATTERIES.**



**WARNING! EXHAUSTED BATTERIES MUST BE TREATED WITH CARE AND DISPOSED OF ACCORDING TO ANY SAFETY OR RECYCLING REGULATIONS IN FORCE IN YOUR LOCAL AREA, NEVER DISPOSE OF BATTERIES INTO GENERAL WASTE, OR FIRE.**



**WARNING! NEVER EXPOSE BATTERIES TO EXCESSIVE HEAT SUCH AS SUNSHINE, FIRE OR THE LIKE.**

## Aerial connection

**WARNING! ENSURE THE TV AND ALL ANCILLARY EQUIPMENT IS UNPLUGGED FROM THE MAINS BEFORE MAKING ANY CONNECTIONS!**

### Connecting the TV Antenna

Connect the TV antenna to the aerial socket with a 75 ohm co-axial plug. For best results use a high gain TV aerial, preferably roof or loft mounted.

- To improve picture quality in a poor signal area, purchase and install a signal amplifier.
- If the antenna needs to be split for two TVs, use a 2-Way Signal Splitter (not supplied).

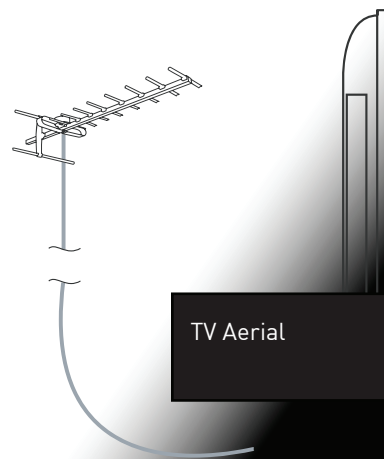

## Connecting external devices

This instruction manual shows the simplest and most effective way of connecting your TV to ancillary equipment. Alternate methods are listed below.

### HDMI Lead

You can connect this TV to a compatible device using a HDMI lead. This method will give the best picture.

Connect the cable from the HDMI equipment to the TV HDMI socket.

### SCART Lead

You can connect this TV to a compatible device using a SCART lead. The connection uses component video signals, i.e. the red, green and blue (RGB) content of the video are sent on separate signals.

### VGA Cable

You can use your TV as a monitor for your personal computer by using a VGA cable. Sound from your personal computer may also be played through the TV.

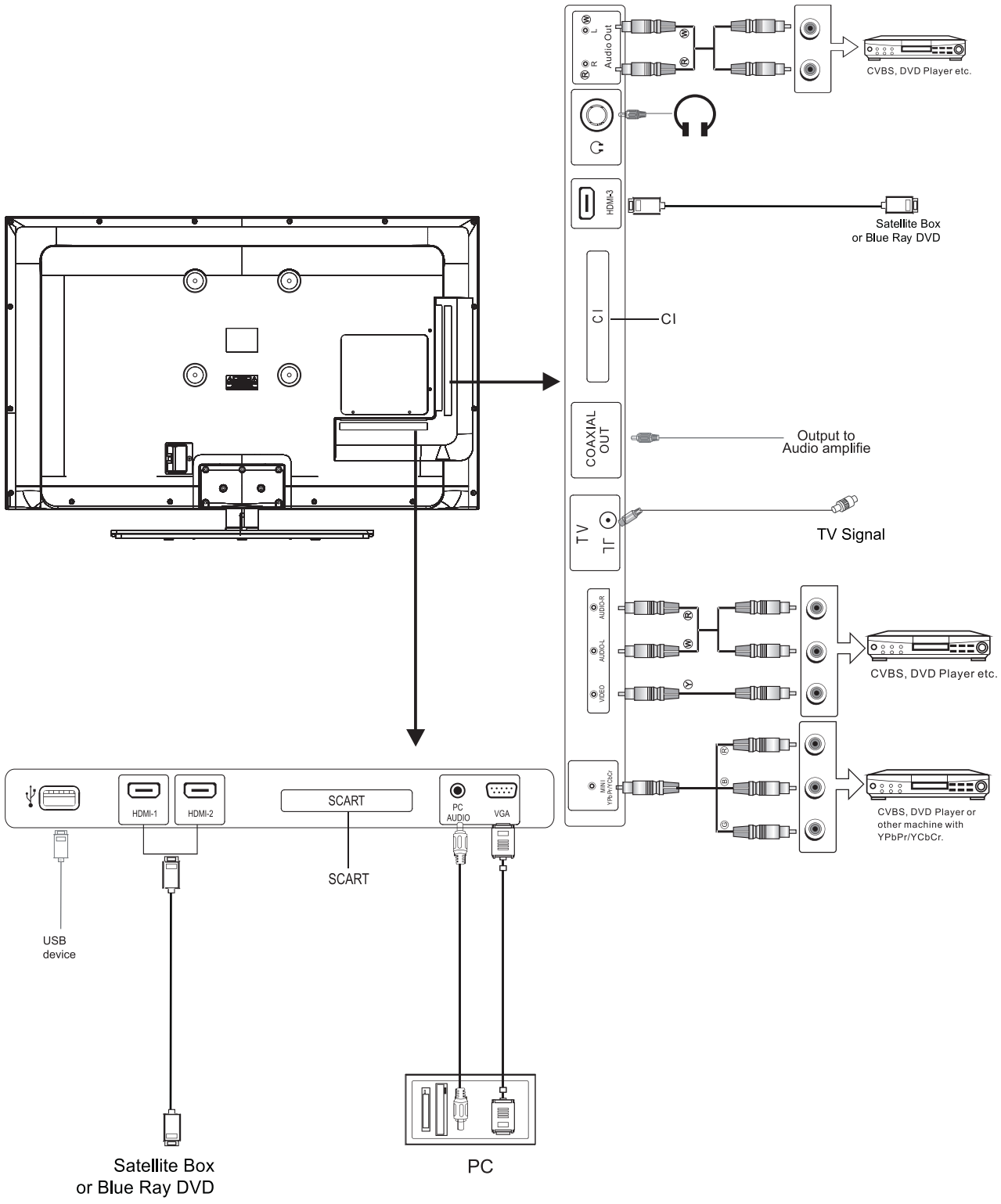

## Connecting external devices (continued)

### CONNECTIONS

Name	Function Description
USB	Connect to USB device for multimedia
HDMI 1, 2, 3	Connect to the HDMI socket of your DVD or Satellite Box
SCART	Connect to the Scart input / output of external devices
PC-IN	PC audio input
VGA	Connect to the PC VGA output to display PC graphics
Headphone	Connect Headphone
Mini YPbPr	Connect to the YPbPr output on external devices
Video	Connect to the video output of external devices
L/R audio in	Audio signal input for AV (Shared with YPbPr)
TV	Connect to aerial or cable source
CI	CI slot (pay as you view card slot)
COAXIAL OUT	Output to audio amplifier
RCA AUDIO OUT	Output to audio amplifier

#### Caution:

Before connecting external devices:

- Makes sure to disconnect the appliances from the power supply in order to avoid any potential damage from occurring.
- Make sure to establish the required connection.
- Make sure that the connectors are properly and correctly attached before connecting the appliances to the power supply.

#### PC connection

As PCs are sometimes still supplied with a 'conventional' CRT monitor, you may need to adjust the display settings of your PC's graphics card, otherwise the pictures may not appear correctly. Switch on your PC (still with your original monitor connected) now select the screen resolution, and select 60Hz refresh rate. Switch off your PC, then connect it to your TV while both appliances are still switched off.

#### VGA, HDMI PC Connection

Use a PC-VGA cable (not supplied) to connect the TV to your PC. You can also use an HDMI cable to connect to your PC (if your PC Graphic card supports HDMI). When the HDMI cable is used, the PC audio cable is no longer required. If you use the HDMI to DVI cable, you will need to use the PC audio cable. Connect all cables carefully and do not bend or break the connector pins.

When using the VGA cable

- Switch on the TV
- Switch on the PC
- Select PC/VGA as input source

When using the HDMI cable

- Select HDMI as input source

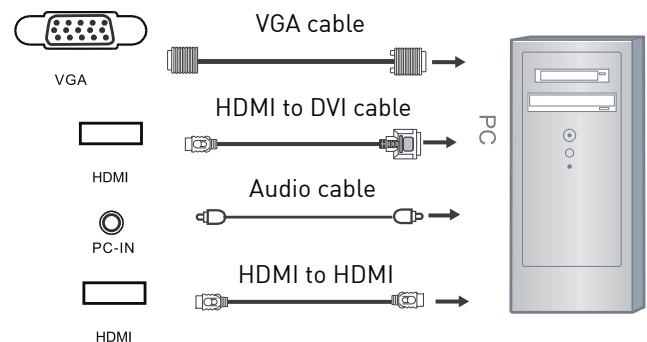

(All illustrated cables are not supplied)

#### Connecting Video camera and Video recorder

##### Video camera

- Connect the AV cable to the TV and to the video camera.
- Turn on both video camera and the TV.
- Select AV/CVBS source
- You can now see the playback picture from the video camera. Note:
- To connect the video camera using other cables, refer to the video camera instruction manual.

##### Video recorder

- Connect the Scart cable to the TV and video recorder.
- Turn on both video recorder and the TV.
- Select Scart source
- You can now see the playback picture from the video recorder.

Note:

- To connect the video recorder using other cables, refer to the video recorder instruction manual.

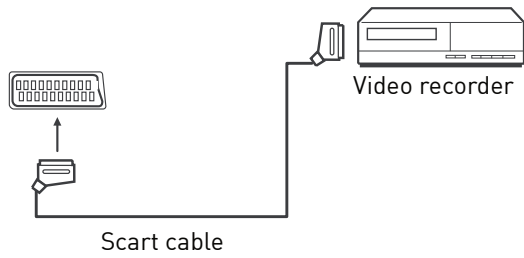

### Use Scart adapter cable

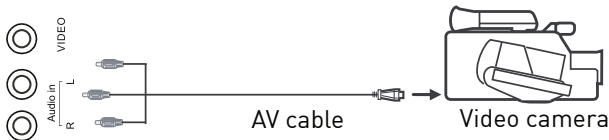

[All illustrated cables are not supplied]

### Connecting an audio system

You can supply the TV sound to the stereo system (A) with the Scart socket. Use a special Scart cable SCART to RCA. (Please consult your hi-fi instructions for details). If you have a surround sound amplifier/decoder (B) Use the RCA audio cable or the special Scart cable Scart to RCA.

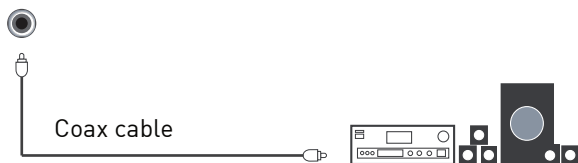
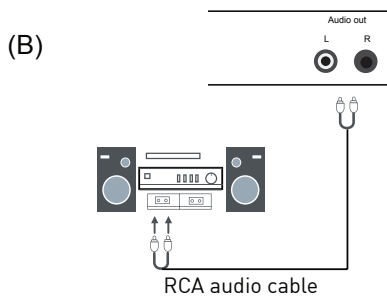
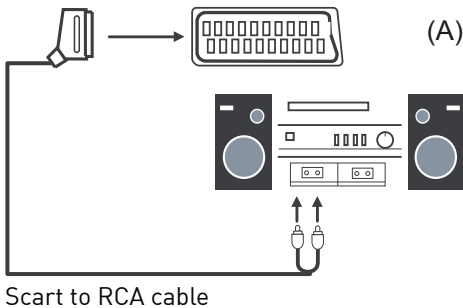

[All illustrated cables are not supplied]

### Connecting a DVD player

Connect a DVD player using either a SCART cable, the HDMI cable or YPbPr cable (only if your external equipment supports HDMI).

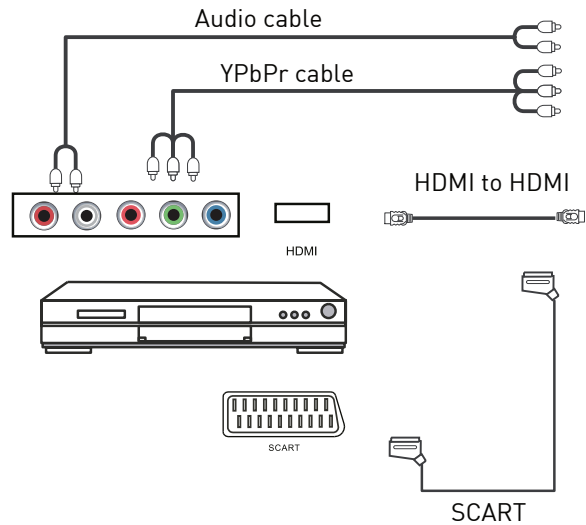

[All illustrated cables are not supplied]

When using the SCART cable

- Switch on the TV
- Switch on the DVD player
- Select SCART as input source

When using the HDMI cable

- Select HDMI as input source

When using the YPbPr cable

- Select YPbPr as input source
- Note the color of the jack
- Connect the audio jack

## Common Interface Slot

### USING YOUR COMMON INTERFACE SLOT

#### Common Interface

The Common Interface (CI) slot is designed to accept the Conditional Access Module (CAM) and Smart Card in order to view the pay TV programmes and additional services. Contact your Pay Per View TV service provider to get more information about the modules and subscriptions.

NOTE: Conditional Access Module and Smart Cards are sold separately.

**WARNING! SWITCH OFF YOUR TV BEFORE ANY MODULE IS INSERTED INTO THE COMMON INTERFACE SLOT, THEN ADD THE SMART CARD TO THE CAM.**

CI Slot

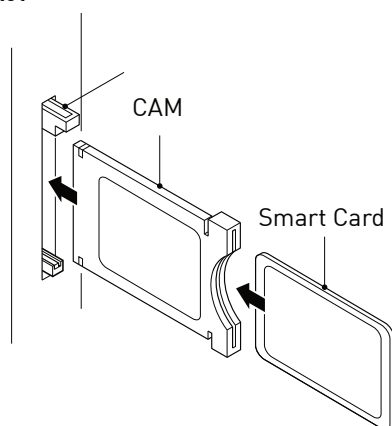

1. Turn on the TV and ensure 'DTV' Source is selected.
2. If the CAM is detected the TV will display the following message on the screen. "Common Interface Module inserted" wait for a few moments until the card is activated.
3. Select the relevant digital Pay Per View channel.
4. Detailed information on the Smart Card in use is displayed
5. Press the Ok button to access the card menu. Refer to the Module Instruction Manual for setting details.
6. When the module is removed, the following message will appear on the screen. "Common Interface module removed".

## Auto installation setup

### Power On / Off the LED TV

#### To turn on the LED TV

Connect the mains lead to the AC power supply and connect the aerial cable to the TV input socket. Make sure the power switch on the right hand side of the TV is set to ON. The standby indicator will be red.



Press the standby button on the TV or the  button on the remote control, the standby indicator will turn green.

#### To turn off the LED TV

Press the standby button on the LED TV or the  button on the remote control, the standby indicator will light red.

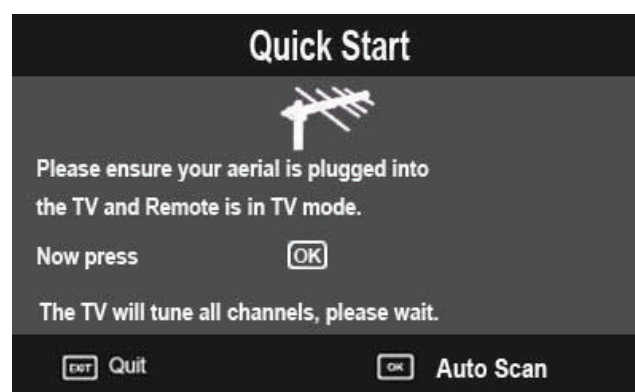
When you initially turn on the LED TV you will see the first time installation menu as below:



Ensure that the aerial is plugged into the TV, Make sure your Remote is in TV mode (by pressing  button), switch on the TV by pressing  . You will see the first time installation menu.

Press the  button on the remote control to start the tuning procedure. This process will find all available ATV and DTV channels and store them.

By pressing the Quick Start button the first time installation can be recalled at any time.

## Source Menu

You can select the input source menu by pressing the Source button.

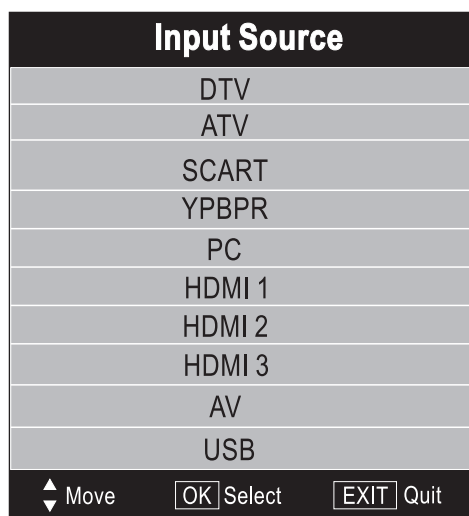

Press Source button on the remote control.  
Use ▲▼ to move to the desired input source  
Press  to select.

## Menu Settings

1. Turn the LED TV on.
2. Press the Menu button on the Remote Control.
3. Use the ◀ and ▶ buttons to navigate through the menu.
4. Press the Exit button to exit the Menu.

### TV SETTINGS MENU

Allows you to search channels and set up a variety of channel options. (Select DTV source for example)

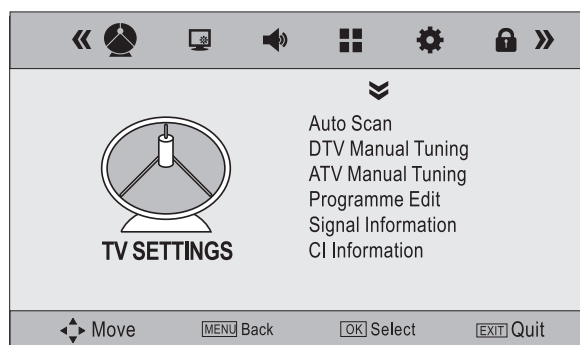

### PICTURE MENU

Allows you to make adjustments to your picture settings.  
(Select DTV source for example)

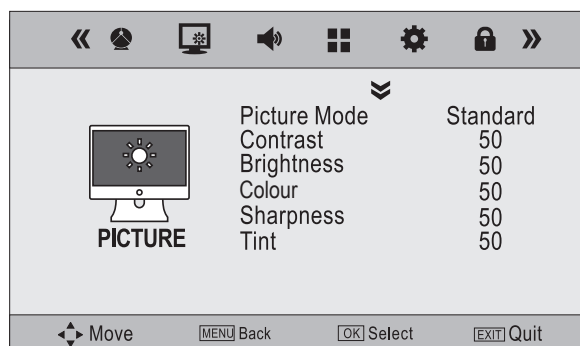

### SOUND MENU

Allows you to customize the sound options and effects.  
(Select DTV source for example)

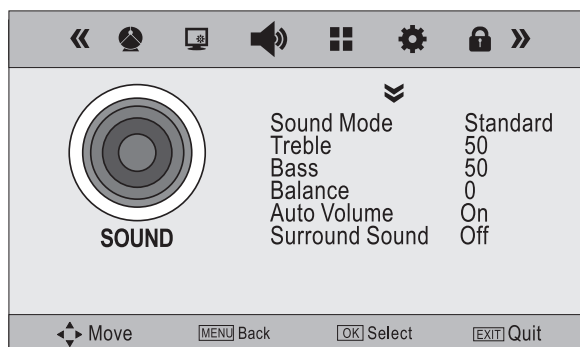

## EXTRAS MENU

Allows you to setup a variety of options. (Select DTV source for example)



## OPTIONS MENU

Allows you to set up a variety of options. (Select DTV source for example)



## LOCK MENU

Allows you to set up a variety of lock options. (Select DTV source for example)



## Menu Settings (continued)

### TV SETTINGS MENU

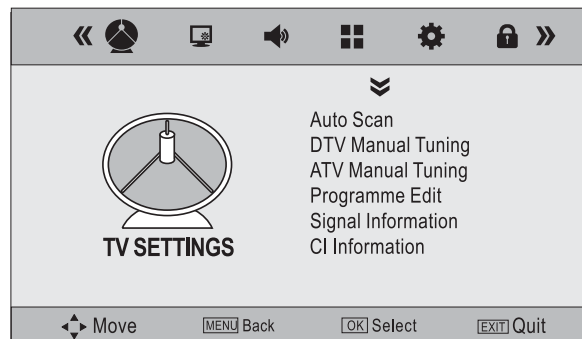

### Auto Tuning

Press the OK button to enter the menu, and select the Country and Tuning mode for the TV, then Press OK button to start the auto tuning.

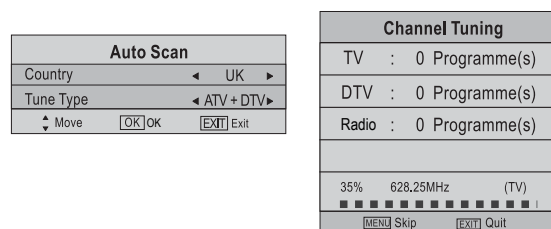

### DTV Manual Tuning

Press the OK button to enter the DTV Manual Tuning menu, select a DTV channel, press the OK button to start searching.

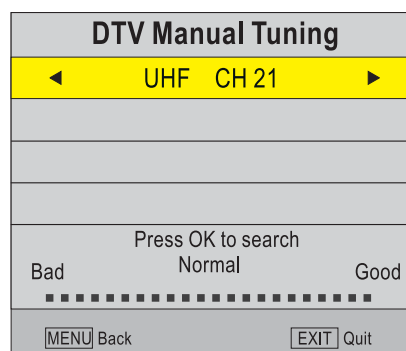

### ATV Manual Tuning

Press the OK button to enter the ATV Manual Tuning menu.  
 Storage To: Storage the channel.  
 System: Select a TV system for searching.  
 Current CH: Select the channel you want to manual tune.  
 Search: Press ◀▶ button to start search.  
 Fine Tune: Press ◀▶ button to fine-tune.  
 Frequency: Display the current frequency.

Note: Press Exit button to exit menu.



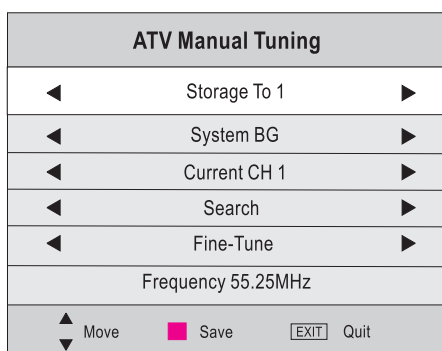

## Menu Settings (continued)

### Programme Edit

Press the OK button to enter the Programme Edit menu as below.

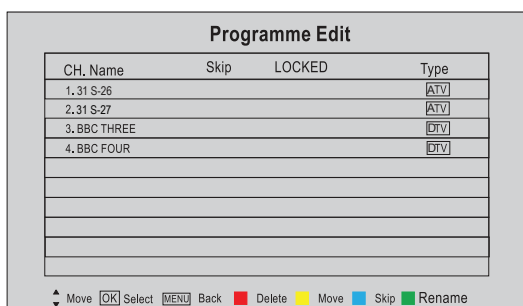

**Delete:** Select a channel and press the RED button twice to delete it.

**Move:** Select an ATV channel, and press the YELLOW button, then you use ▲ ▼ buttons to change the position of the programme, press YELLOW again to confirm the change. Press menu to exit and your new changes will be saved. (for ATV mode only)

**Skip:** Select a channel and press the BLUE button, this will label the channel. As long as the channel has a skip label it will be skipped when searching through the channels using the CH+/- buttons.

**Rename:** Select an ATV channel, and press the GREEN button, then you use ◀ ▶ buttons to move the cursor position, use ▲ ▼ button to select the character, press OK button to exit and saved. (for ATV mode only)

### Signal Information

Displays the digital TV-signal information (DTV mode only).

### CI Information

Please contact your "pay per view" provider who can supply a viewing card and cam unit with instructions for their use.

## PICTURE menu

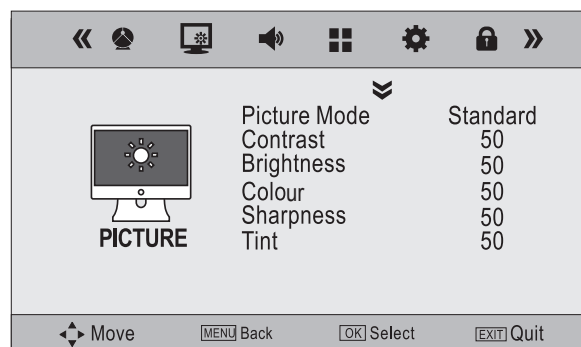

**Picture Mode:** Choose from Dynamic, Standard, Mild and User.

**Note:** Contrast, Brightness, Colour and sharpness are only available and can be adjusted in the Personal mode option in the Picture Mode Settings.

**Contrast:** Controls the difference between the brightest and darkest regions of the picture.

**Brightness:** Controls the overall brightness of the picture.

**Colour:** Control the colour.

**Sharpness:** Increase this setting to see crisp edges in the picture; decrease it for soft edges.

**Tint:** Controls the tint ( NTSC mode only).

**Colour Temperature:** Choose from Cool, Medium, Warm and User.

**Red:** Controls the red colour of the picture.

**Green:** Controls the green colour of the picture.

**Blue:** Controls the blue colour of the picture.

**Aspect Ratio:** Choose from 4:3, 16:9, Zoom1, Zoom2 and Panorama.

**Noise Reduction:** Choose interference noise modes from Off, Low, Middle and High.

## Sound Menu

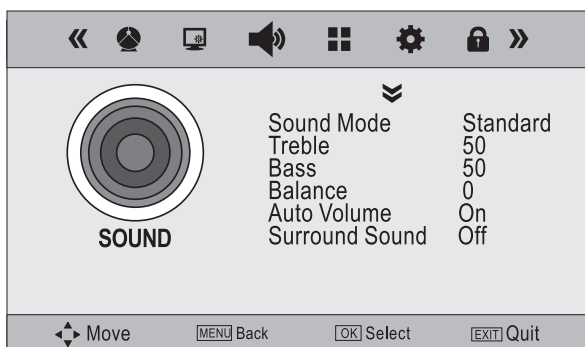

**Sound Mode:** Allows you to select Standard, Music, Movie, Sports or User. Note: Treble, Bass, Balance can only be adjusted when set in User mode.

**Treble:** Controls the relative intensity of higher pitched sounds.

**Bass:** Controls the relative intensity of lower pitched sounds.

**Balance:** Controls the volume between the left and right speaker.

**Auto Volume:** Controls the TV's volume automatically when On is selected

**Surround Sound:** Turn on/off the surround sound function by selecting "On" or "Off".

## Extras Menu



**Sleep Timer:** Allows you to setup the sleep timer among 10min, 20min, 30min, 60min, 90min, 120min, 180min, 240min and off.

**PC Setup (PC mode only):** Press the OK button to enter the submenu to adjust the Horizontal / Vertical position or size and phase of the picture by ◀▶

## Options Menu



**OSD Language:** choose the menu language

**Audio Language** (can only be selected in DTV mode): Select the audio language.

**Subtitle Language** (can only be selected in DTV mode): Select the subtitle language.

**Menu Time Out:** choose the menu display time on screen.

**Blue Screen:** Set the screen background colour blue or not when no valid signal input.

**Country:** This function is disabled.

**DVD Setup:** Press OK button to enter DVD Setup menu.

**Restore Settings:** Press the OK button to enter and select "Yes" to restore the factory default settings.

## Lock Menu



**Lock System:** Turn On/Off the lock system function

**Note:** you should enter the code to operate the menu (Default code is 0000)

**Set Password:** If the code has been changed you must enter the current password.

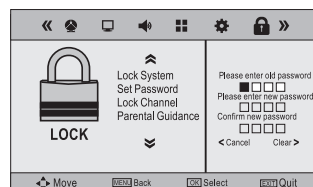

**Please enter old password:** Enter current password.

**Please enter new password:** Enter new password.

**Confirm new password:** Enter new password again.

If you change the password, be sure to remember the new password! If you forget use the master password "8899".

**Lock Channel:** Use ▲▼ buttons to select the channel and press the GREEN button on the remote control to lock the channel.

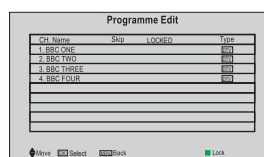

**Note:** You must enter your password to view channels that have been blocked.

**Parental Guidance:** Allows you to select the parental guidance mode.

## Multimedia Operation

### Basic Operation

1). Press the SOURCE button on the remote control to display the input source menu, select the USB source with the  $\blacktriangledown$   $\blacktriangle$  buttons and press the OK button to enter the Multimedia menu below.

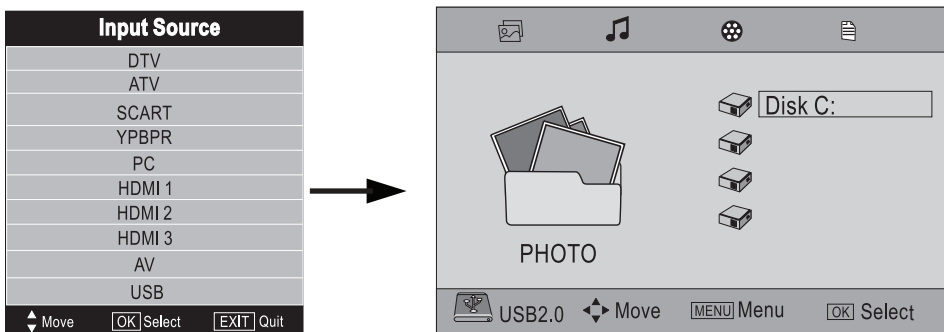

2). Insert the USB device, the name of the device will be displayed on the screen.



Information of the USB device

3). Press  $\blacktriangleleft$ / $\blacktriangleright$  button to select the files on the USB device (PHOTO, MUSIC, MOVIE, TEXT) to view or play.

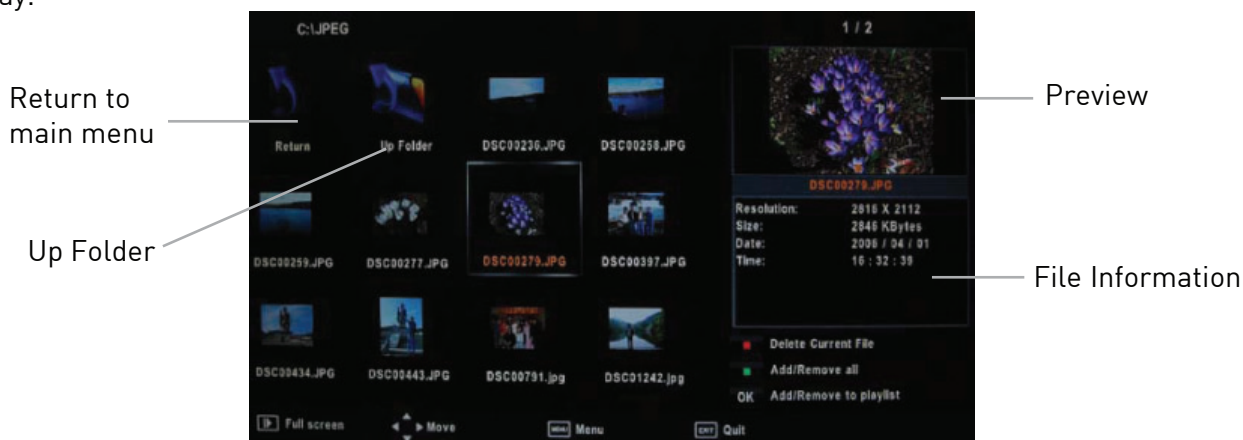

Press  $\blacktriangleleft$ / $\blacktriangleright$ / $\blacktriangle$ / $\blacktriangledown$  buttons to select and the OK button to activate the file or open folder. Press  $\blacktriangleright$  button to play the files in full screen mode. When in full screen mode press the **OK** button to show the navigation option menu on the bottom of the screen or press  $\blacksquare$  stop button to return to files.

## Multimedia Operation (continued)

### 1. Photo

Photo viewing



Press ◀/▶ buttons to select the option on the menu, and press the OK button to activate.

**Repeat:** Select the repeat mode from Repeat All, Repeat 1, Repeat None.

**Music:** Play/Pause the background music of your choice.

**Playlist:** Display the playlist on the screen and select the photo of your choice.

**Info:** Display the information of the file.

**Rotate:** Rotate the photo clockwise/counterclockwise.

**Zoom In/Out:** Zoom In/Out of your photos.

**Move View:** Move the photo in Zoom out mode.

---

### 2. Music

Listen to music



Press ◀/▶ buttons to select the option on the menu, and press the OK button to activate.

Press ▼/▲ buttons to select the music, and press the OK button to play.

**Repeat:** Select the repeat mode from Repeat All, Repeat 1, Repeat None.

**Search:** Program the music to play from the time you set.

Press the OK button to display the time table, and select the position with the ◀ ▶ ▼ ▲ buttons, set the time using the numeral buttons on the remote, select "OK" and press the OK button to search.

**Screen Saver:** Press the BLUE button to enter the Screen Saver mode, press again to exit.

## Multimedia Operation (continued)

### 3. Movie

Watch a film



Press ◀/▶ buttons to select the option on the menu, and press OK button to activate.

**Repeat:** Select the repeat mode from Repeat All, Repeat 1, Repeat None.

**Set A-B:** Select and play the preferable part of the file by setting A and B at the beginning and end. Press OK button to cancel.

**Playlist:** Display the playlist on the screen.

**Info:** Display the information of the movie file.

**Slow:** Play the movies at slow speed, press ▶▶ button to cancel and resume at normal speed.

**Step:** Step quickly through the movie by using this option

**Search:** Program the movie from the time you set.

**Zoom In/Out:** Zoom In/Out of the movie screen.

**Aspect Ratio:** Select the aspect ratio of the on screen display.

**Move View:** View the film in Zoom out mode.

### 4. Text

View text files

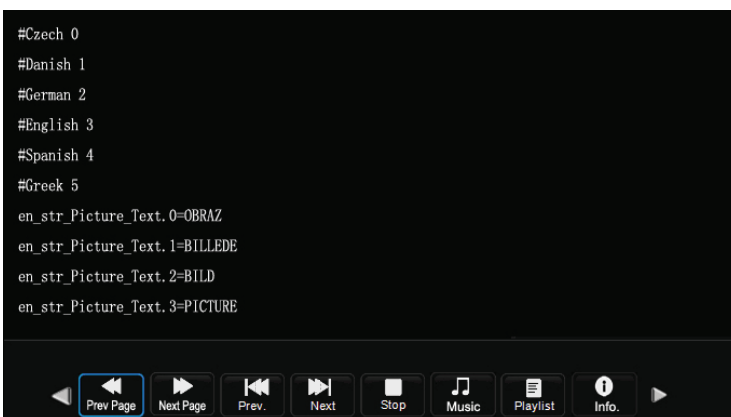

Press ◀/▶ buttons to select the option on the menu, and press the OK button to activate.

**Prev/Next page:** Turn to previous/next page of the text.

**Prev./Next:** Turn to previous/next file.

**Stop:** Stop auto turning pages.

**Music:** Play/pause the background music of your choice.

**Playlist:** Display the playlist on the screen.

**Info:** Display the information of the text file.

# Recording Operation

## Start Recording:

Press OK button to enter the recording menu as below:



## Note:

Press **■** button on the remote control or select Stop to stop record.

**Schedule List:** Press to display Schedule List.

Note: Delete any scheduled recordings out with the RED button.

## Recorder List:

Press OK button to enter the recorder list menu:

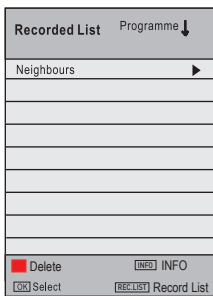

Press RED button to delete any programme.  
Press Info button to display programme informations.

Note: You can press the SD1 button on the remote control to display the recorded list.

## Timer Record:

The TV will record the programme automatically according to your settings. Press OK button to enter the timer record.

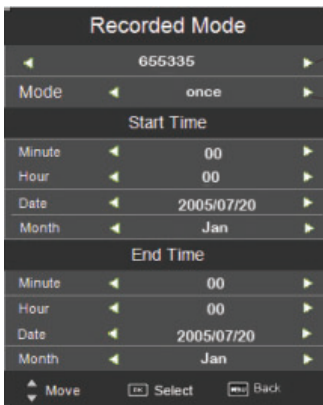

Select the channel you want to record.  
Select the record mode.

**Start Time:** Select the start recording time.

**End Time:** Select the end recording time.

Press the OK button to save the setting and exit the menu.

**PVR File System:** Press the Menu button and select the EXTRAS menu, choose PVR File System and press OK.

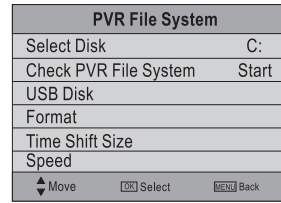

**Select Disc:** Select the USB device to record on.

**Check PVR File System:** Check the system of the USB device

**USB Disc:** Displays information

**Format:** Format the USB device for PVR operating

**Time Shift Size:** Displays the memory size of the USB device

**Speed:** Displays the speed of the USB device

## Recording

### Record and Time shift function buttons

**R Recording:** Press to start recording.

**▶ PAUSE:** Press to enter the timeshift mode, press again to play the recording.

**■ Stop:** Press to stop recording or timeshift.

**A:** Displays the list of programmes scheduled for recording.

**SD1:** Displays the list of programmes already recorded on the USB device.

### Recording menu

When you press **R REC** button, the screen will display the recording menu as below:

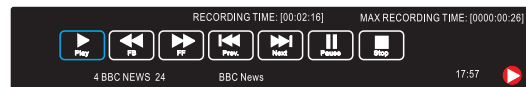

Full mode



Simple mode

Note: a. display and exit full mode by pressing the **R REC** or Exit buttons.

b. Press the STOP button to stop the recording and exit the recording mode.

## Time shift

When you press the **▶** Pause/Play button the picture will be paused and the navigation menu will displayed on screen



- Note: a. Display and exit the navigation menu by pressing the Exit button.  
 b. Press the STOP button to exit the Timeshift mode.  
 c. Press **▶** PLAY button to play the programme you are recording from the beginning.

Press the **▼/▲** buttons to highlight the channel option, press **◀ / ▶** buttons to select the channel you want to view.

You can select a programme for recording using the **▼/▲** buttons.

**Record:** Press **R** button to display the Recorded Mode menu, and set the timer record. When the programme starts it will be recorded to the USB device.

**Remind:** Press the GREEN button to display the remind menu, and set the time. When the programme starts the TV will automatically switch to this programme.

**Schedule:** Press the YELLOW button to display the schedule list.

**To Top:** Press the BLUE button to return to and highlight the top of the table.

## EPG menu

Display the programme guide by pressing the GUIDE button.

Press the BLUE button to highlight the top of the table in yellow, press the **◀ ▶** to select CHANNEL or TIME.

### Programme list by TIME

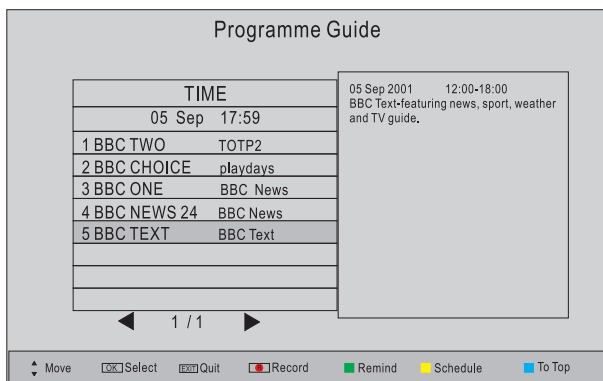

Press **▼ ▲** buttons to highlight the date, now press the **◀ ▶** buttons to select the date you want to view (7 day EPG)

### Programme list by CHANNEL

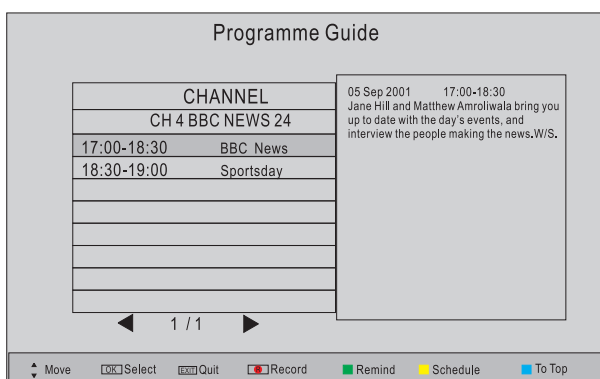

---

## TROUBLE SHOOTING GUIDE

To assist in locating possible faults use the help guide below.

SYMPTOM	SOLUTION
No Picture, no sound	Check that the TV is correctly plugged in. Check that the TV is connected to a suitable power source. Check the electrical supply is turned on.
No Picture	Ensure that the TV is powered on. Check that the cables are fitted securely. Ensure the aerial and/or external sources are connected. Press the SOURCE button to change the source. Turn the TV on or off.
No Sound	Press the MUTE button and check if Mute mode is set. Switch to another channel and see if the same problem occurs. Press V+ button to see if the problem can be solved.
No picture on some channels	Check that correct channel is selected. Adjust the antenna.
No colour on some channels (black & white)	Check if the same problem exists on other channels. Ensure the correct picture settings are selected.
Noisy, Snowy, Ghosting picture.	Check the antenna is connected correctly. Check that the antenna is in good condition. Try moving the antenna.

If none of the suggestions seem to work, try switching your TV off and then on again. If this does not work contact our technical helpline.

NOTE: The TV must only be repaired by a qualified registered service person. Never attempt to remove the back cover as the TV has dangerous voltages inside that may cause fatality or fire.

## TECHNICAL SPECIFICATIONS

Specifications of the TV that you have just purchased may vary from the information in this table due to technical innovations.

### TV Specifications

TV System	PAL/BG/DK/ I
Audio System	BG/DK/I
Screen size	42" (Diagonal)
Resolution	1920 x 1080 Pixels (RGB)
Aerial input	75 Ohm (unbalanced)
Audio output power	2 x 8W
Power requirements	100-240V ~ 50/60Hz
Power consumption	Max 138W
Standby power consumption	<0.5W
Weight	15.2Kg



## Remote control specifications

Type	Infrared
Control distance	5m
Control angle	30 degrees (Horizontal)
Batteries	2 x 1.5V, Size AA
Dimensions	48 x 193 x 20mm
Weight	120g (without batteries)

## Wall Mounting

1. The stand must first be removed. Place the TV face down.
2. Remove the seven screws on the back of the TV to release the stand.
3. Remove and store the stand and screws.
4. Use four machine screws to mount the TV on the bracket.

This unit is VESA-Compliant and designed to be wall mounted with a VESA-Compliant 400mm x 400 mm mounting kit. Mount this unit according to the instructions of the wall bracket (not supplied)

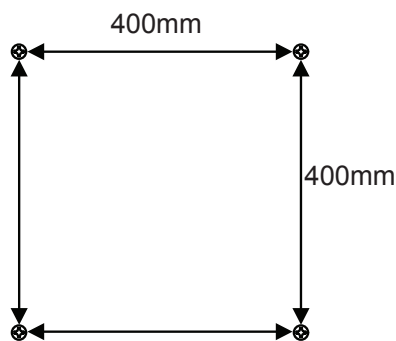



Screw size M 6 x 30

## Waste Electrical Recycling

### Correct disposal of Product

 This sign indicates that this product may not be disposed of with your regular household waste. The recycling and separate collection of such products is your responsibility. Please drop off the above mentioned waste at a designated place for recycling waste electrical and electronic equipment. If you do not know where to drop off your waste equipment for recycling, please contact your local city office or household waste collection service.

 The crossed out wheeled dust bin symbol indicates that batteries and /or accumulators must be collected and disposed of separately from household waste.

**Hg Cd Pb**  
 If the battery or accumulator contains more than the specified values of lead (Pb), mercury (Hg), and/or cadmium (Cd) defined in the Battery Directive (2006/66/EC), then the chemicals Hg Cd Pb symbols for lead(Pb), mercury (Hg) and/or cadmium (Cd) will appear below the crossed out wheeled dust bin symbol.

By participating in separate collection of batteries, you will help to assure the proper disposal of products and batteries thus help to prevent potential negative consequences for the environment and human health.

For more detailed information about the collection and recycling programmes available in your country, please contact your local city office or the shop where you purchased this product.



This appliance complies with European Safety and Electrical directives.

It fulfils the following EU regulations:

En55013:2001+A1:2003+A2:2006

EN55020: 2007

EN61000-3-2: 2006 EN61000-3-3:1995+A1:2001+A2:2005

EN55022:2006(CLASS-A)

EN55024:1998+A1:2001+A2:2003

