

LCD digital colour TV

C32E69DVB-DLED

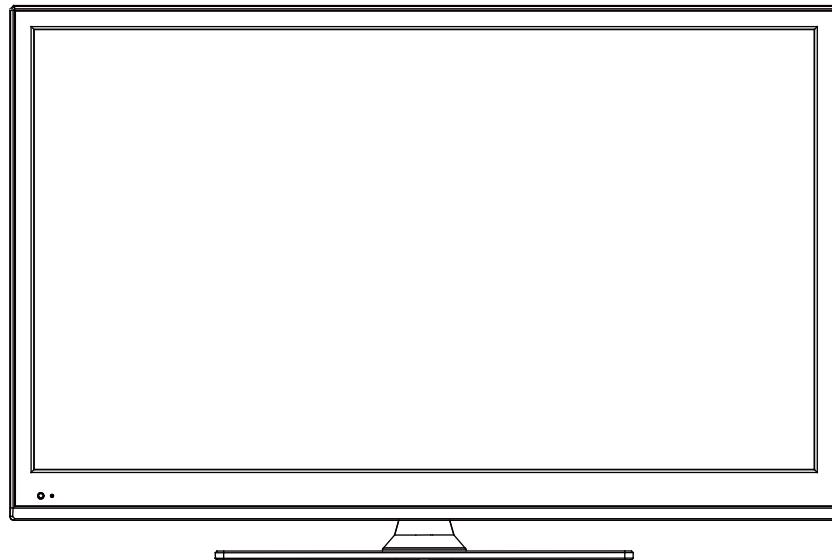

User Guide

Contents

Unpacking the TV / Accessory's.....	3
Installing / Removing the Base Stand	4
Front / Right Side View and Controls.....	5
Rear View and Sockets	6
Remote Control	7-8
Installing Batteries in the Remote Control	9
Remote Control Operation Range.....	9
Making Video and Audio Connections.....	10
Connecting an AV Device with an HDMI Cable	10
Connecting a Computer with a VGA Cable.....	11
Connecting an AV Device with a Component (YPbPr) Cable.....	11
Connecting an AV Device with a SCART Cable	12
Connecting an AV Device with Composite Cable.....	12
Connecting a Digital Audio Receiver	13
Connecting an Audio Receiver	13
Connecting Headphones.....	14
Turning the TV on for the First Time	14-15
– Selecting the Input Source.....	15
– Channel Selection	15
– Display Channel Information	15
– Volume Adjustment.....	15
Channel Setting (TV, DTV or Radio Mode).....	16-20
– Auto Tuning (ATV / DTV mode).....	16
– ATV Manual Tuning (ATV mode)	17
– DTV Manual Tuning (DTV mode)	17
– Channel Edit (ATV Mode)	18
– Channel Edit (DTV Mode).....	18
– Signal Information (DTV Mode).....	19
– CI (Common Interface) (DTV Mode).....	19-20
– Software Update(USB) (DTV Mode).....	20
Picture Setting	21
Sound Setting	22
– Stereo / Dual Sound Reception (ATV Mode).....	22
– Speaker Sound Output Selection (DTV Mode)	22
Extras Setting	23-24
– Sleep Timer.....	23
– No Action Auto Standby	23
– Start Recording	23
– Schedule List.....	23
– Recorded List	23
– Timer Record	23
– PVR File System(DTV Mode)	24
– PC Setup(PC mode only).....	24
Option Setting	25

Lock Setting	26- 27
– Lock System	26
– Set Password	26
– Lock Channel	27
– Parental Guidance	27
EPG (Electronic Programme Guide) (DTV Mode)	28
– Switch On / Off EPG.....	28
– Select a Programme	28
Teletext (ATV Mode).....	29
– To Turn on Teletext Function.....	29
Digital Teletext (DTV Mode).....	29
– Teletext within Digital Service.....	29
Connecting a USB Storage Device.....	30
Multimedia Operation	31
Viewing Photos.....	32
Listening to Music.....	32
Watching Movies.....	33
Viewing Texts	33
Time Shift Function (DTV Mode).....	34
Recording DTV Programme onto a USB Storage Device	35
Timer Programming	35
Play Recorded Programme	36
Maintenance	37
Hints and Tips	37- 38
Display Modes.....	39
YPbPr Mode	39
PC Mode	39
HDMI Mode	39
Specifications	40
Safety Warnings	41- 42
Waste Electrical Recycling.....	43

Thank you

for purchasing your new 32" HD Ready TV
Your new TV has many features and incorporates the latest technology to enhance your viewing experience. We recommend that you spend some time reading this instruction manual in order that you fully understand these features. You will also find some hints and tips to help you resolve any issues. Read all the safety instructions carefully before use and keep this instruction manual for future reference.

Unpacking the TV / Accessory's

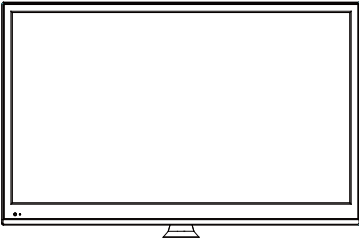

TV set



Stand

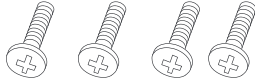

Stand fixing screws
4pcs:PWA 4*12*14mmΦ



Remote Control

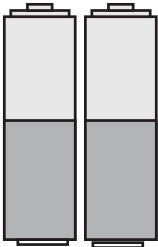

Batteries



Goldcare Plan



Quick Start Guide



Warranty Card



User Guide

Installing / Removing the Base Stand



The LCD display is very fragile, and must be protected at all times when installing and removing the base stand. Be sure that no hard or sharp object, or anything that could scratch or damage the LCD display, comes into contact with it. DO NOT exert pressure on the front of the TV at any time because the screen could crack.

1. Disconnect all cables connected to the TV.
2. Lay the TV down on a flat surface with the back side facing up. Please make sure to place a soft cushioned material (such as a pillow or thick piece of foam) beneath the screen.

3. To install the base stand first make sure you position the front of the base stand facing towards the front of the TV and then use the 4 supplied screws to fix the base stand to the TV.



The screw holes will only align if the front of the base stand is facing towards the front of the TV



Remove the stand base before wall mounting the TV.

4. To remove the stand assembly, lay the TV down on a flat surface with the back side facing up. Please make sure to place a soft cushioned material (such as a pillow or thick piece of foam) beneath the screen. Remove the 4 screws that secure the stand base to the TV. Remove the stand base by sliding it out.



Keep all the screws in a safe place, should you want to attach the stand base at a later date.

This unit is VESA-Compliant and designed to be wall mounted with a VESA-Compliant 200mmx100mm mounting kit. Mount this unit according to the instructions of the wall bracket (not supplied)

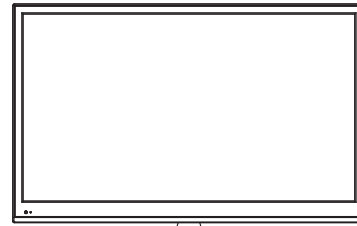

Front

Back

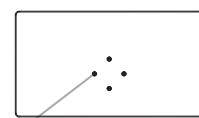

Base cover

Screw holes



Screws

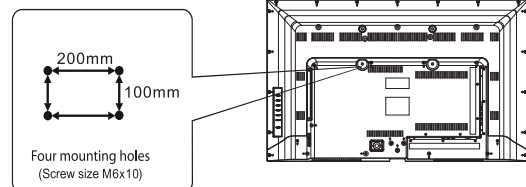
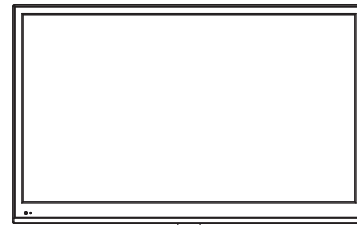

Front / Right Side View and Controls

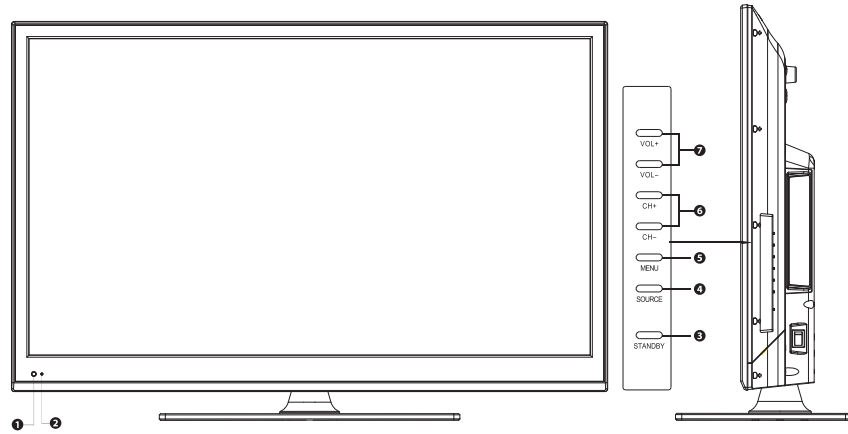

Item	Description
1 IR (Infrared Receiver)	Receives IR signals from the remote control. Do not put anything near the sensor, as its function may be affected.
2 POWER LCD	Illuminates green when the TV is turned on. Illuminates red when the TV is in standby mode. The LED will alternate between red and green when the PVR timer programming has started in the standby mode.
3 STANDBY	Switches the TV on from standby mode. Switches the TV back to standby mode.
4 SOURCE	Press to select among different input signal sources: DTV / ATV / SCART / YPBPR / PC / HDMI1 / HDMI2 / HDMI3 / AV / USB. Confirmed the selection on OSD menu.
5 MENU	Displays the OSD (on screen display) menu.
6 CH + / -	Press to select a channel or select a sub-menu from the OSD menu.
7 VOL + / -	Adjusts the volume. Press to select and adjust a setting in the OSD menu.

Rear View and Sockets

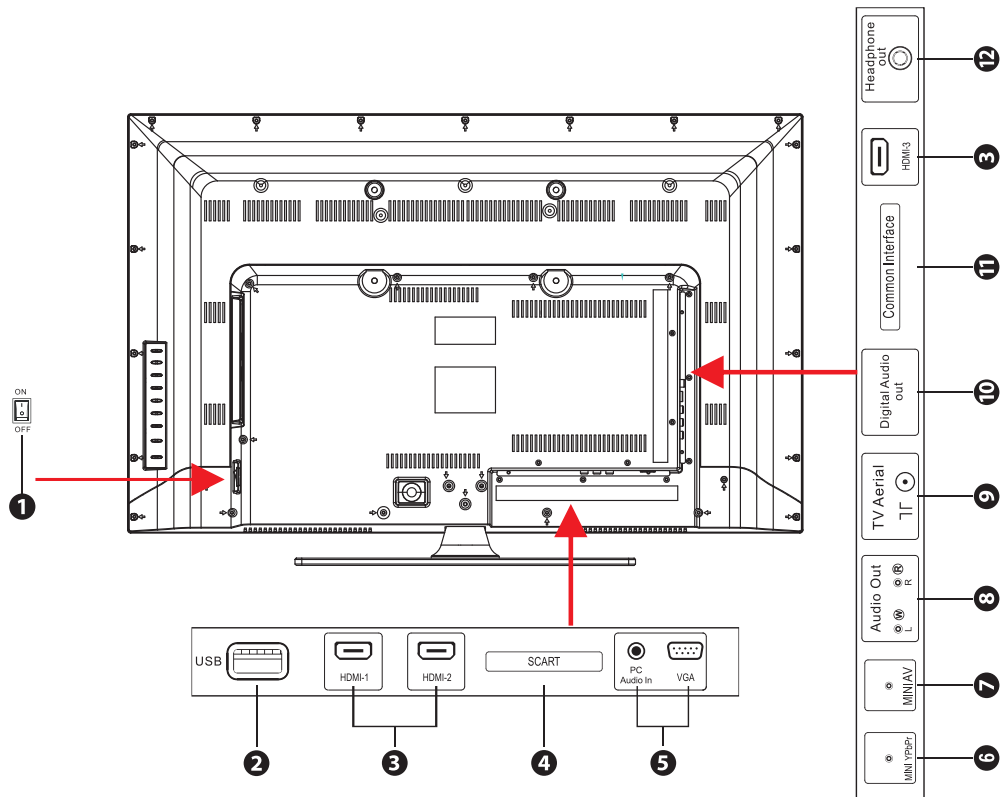

Socket	Description
1 Power switch	Turn ON/OFF the TV set.
2 USB	Allows the insertion of a USB storage device to play video, audio, photo and text files (Media mode) and record DTV programmes on to a USB storage device.
3 HDMI1 / 2 / 3 IN	To connect to a High-Definition (HD) signal output device, such as a set-top box, blu-ray disc player or AV receiver.
4 SCART	To connect to a VCR, DVD Player, or other AV device with a SCART output socket.
5 PC AUDIO IN	To connect to a computer or other devices with a VGA interface.
6 MINI YPBPR / AUDIO (L/R)	To connect to a DVD player, Digital Set-Top-Box, or other AV devices with component (YPbPr) video and audio output sockets.
7 Mini AV	Connect to AV output on external devices
8 Audio out L/R	To connect to the audio sockets on the audio system.
9 TV Aerial	To connect to the aerial socket on the wall with the RF coaxial cable.
10 DIGITAL AUDIO OUT (COAXIAL)	To connect to the audio socket on the digital/standard 5.1 audio system.
11 CI (Common Interface) Slot	Allows the insertion of a Common Access Module.
12 Headphone out	To connect to the earphones.

Remote control

Dependant on the Model of the TV some keys will have no function

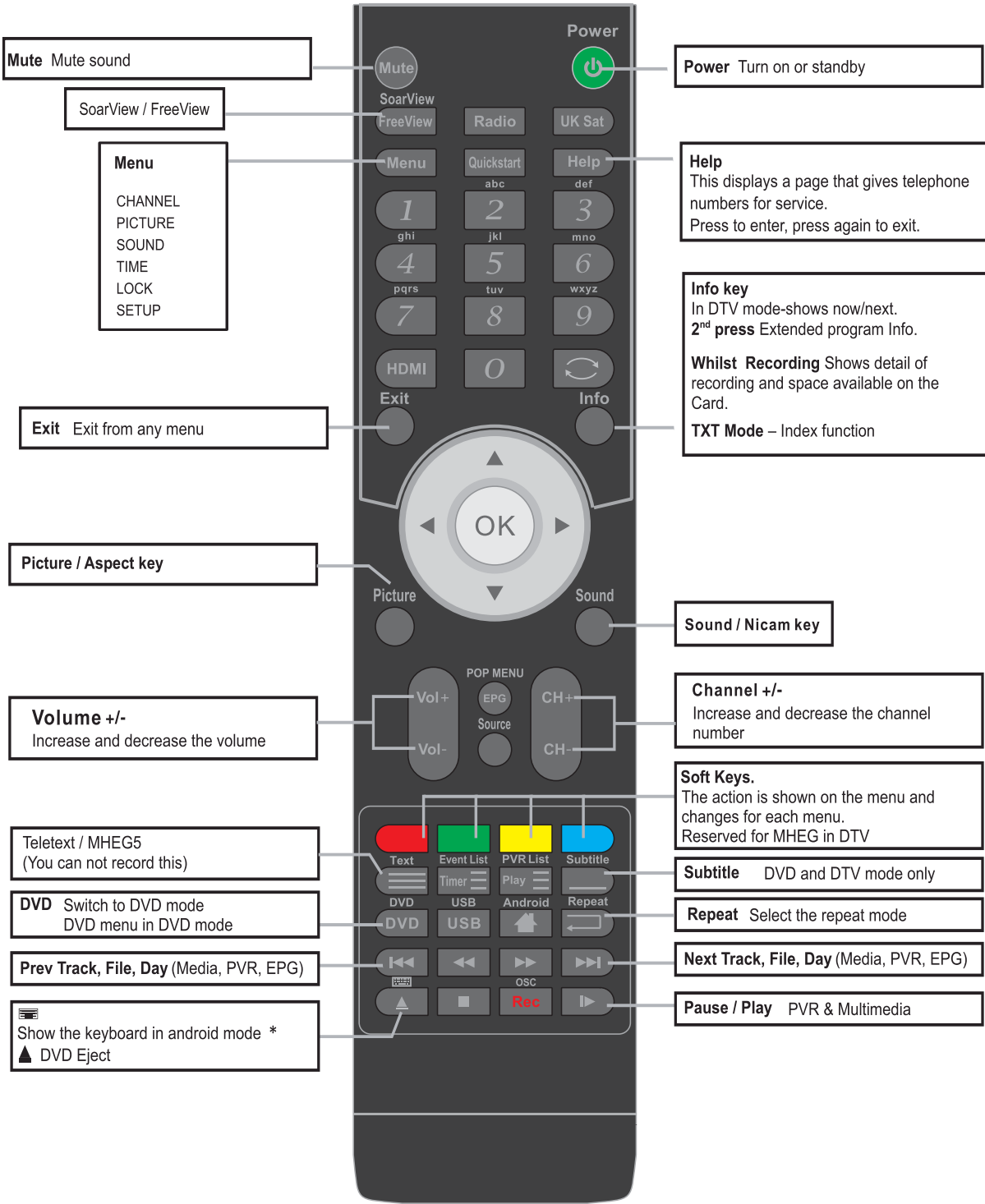

*Dependant on Model

Remote control (continued)

■ Functions of remote control buttons

Dependant on the model of the TV some keys will have no function

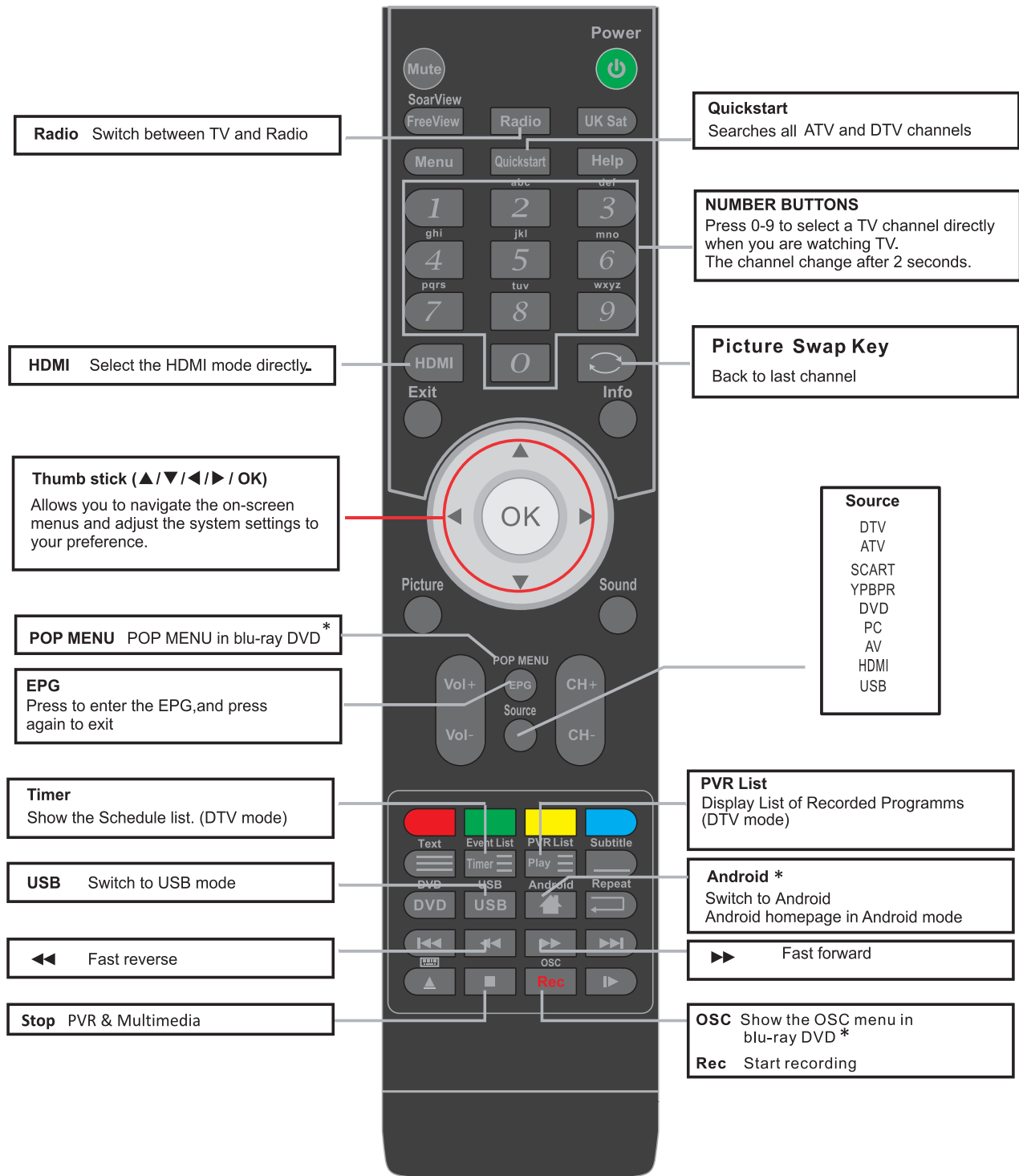

*Dependant on Model

Installing Batteries in the Remote Control

1. Press and lift the back cover to open the battery compartment of the remote control.
2. Insert two 1.5V AA size batteries. Make sure to match the (+) and (-) ends of the batteries with the (+) and (-) ends indicated in the battery compartment.
3. Close the battery compartment cover.

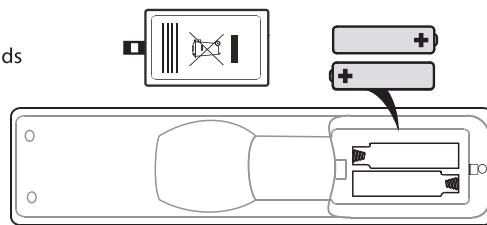

Handling the Batteries

- Improper or incorrect use of batteries may cause corrosion or battery leakage, which could cause fire, personal injury or damage to property.
- Only use the battery type indicated in this manual.
- When the batteries are exhausted, the remote will not function. Replace both batteries at the same time with new ones.
- Do not install new batteries with used ones and do not mix different types of batteries.
- Do not dispose of used batteries as domestic waste. Dispose of them in accordance with local regulations.



Handling the Remote Control

- Take care of your fingernails when you press and hold the battery release tab.
- Do not drop or cause impact to the remote control.
- Do not spill water or any liquid on the remote control.
- Do not place the remote control on a wet object.
- Do not place the remote control under direct sunlight or near sources of excessive heat.
- Remove the battery from the remote control when not in use for a long period of time, as it could cause corrosion or battery leakage and may result in physical injury and/or property damage including fire.

Remote Control Operation Range

Point the remote control at the TV no more than 5 metres from the remote control sensor on the TV and within 60° in front of the TV. The operating distance may vary depending on the brightness of the room.

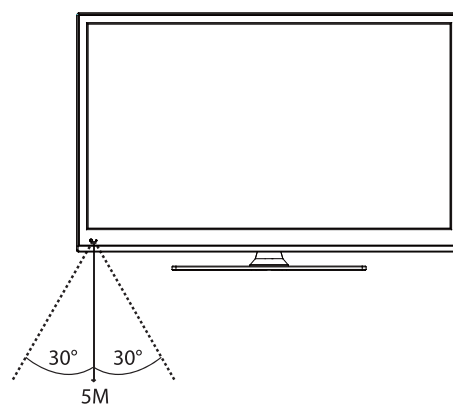

Remote Code:0156









To use your sky remote control with this TV follow the instructions given with the sky remote to programme different codes.



Making Video and Audio Connections



Not all AV devices have the ability to connect to a TV, please refer to the owner's manual of your AV device for compatibility and connection procedures.

When connecting any external AV device, do not connect the mains cable to the mains socket until all other connections are complete.

Best Video Performance ↑	Signal Type	Separate Audio Connection Required
 HDMI	HDMI (480i/480p/576i/576p/720p/1080i/1080p)	No
 VGA	PC	Yes  PC AUDIO
 Component Video (480i/480p/576i/576p/720p/1080i/1080p)	Component Video (480i/480p/576i/576p/720p/1080i/1080p)	Yes 
 SCART (RGB Input)	SCART (RGB Input)	No
 VIDEO	Composite Video	Yes 

Connecting an AV Device with an HDMI Cable

- This TV can accept High-Definition Multimedia Interface (HDMI) and supports HDCP (High-Bandwidth Digital Content Protection) Protocol.
- The TV has a total of 3 HDMI input sockets, please make sure the correct input source is selected corresponding to your connected HDMI input socket.
- When you connect to the output of an HD ready player (blu-ray disc player, game console, set-top box or computer) switch to the HDMI function and the TV will automatically detect the resolution used by the HDMI source.
- To get the best picture quality, adjust the blu-ray disc player, game console or set-top box output resolution up to 1920 x 1080p.

- Use an HDMI cable to connect the TV's HDMI1 / HDMI2 / HDMI3 input socket to the external AV device's HDMI output socket.
- Plug the connected devices into the mains socket before switching on the **POWER SWITCH** which is located at the rear of the TV.
- Press the **STANDBY** button at the front right side of the TV or the  button on the remote control to turn on your TV.
- Press the **SOURCE** button at the front right side of the TV or the **SOURCE** button on the remote control to display the Source List. Use the   buttons to select **HDMI1** or **HDMI2** or **HDMI3** and then press the **OK** button to confirm.

 Although this TV is able to connect to an HDMI device, it is possible that some devices may not operate correctly.

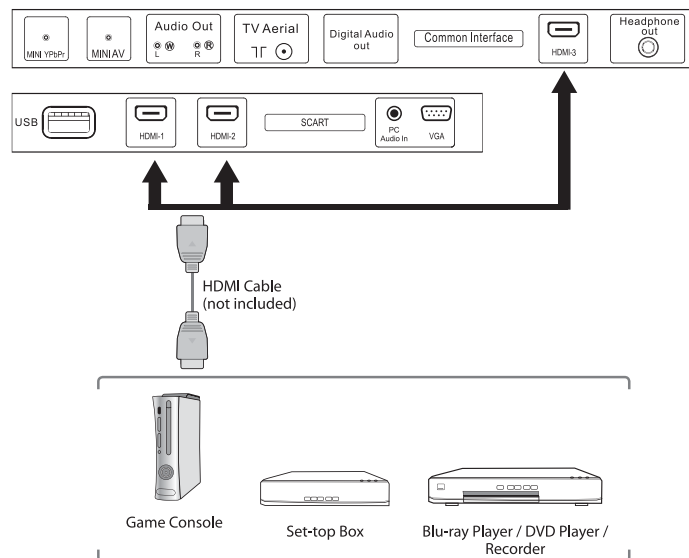

Connecting a Computer with a VGA Cable

1. Use a VGA cable to connect the TV's PC input socket to a computer's VGA output socket. Use an audio cable to connect the TV's PC AUDIO input socket to the computer's audio output socket.
2. Plug the connected devices into the mains socket before switching on the **POWER SWITCH** which is located at the rear of the TV.
3. Press the **STANDBY** button at the front right side of the TV or the  button on the remote control to turn on your TV.
4. Press the **SOURCE** button at the front right side of the TV or the **SOURCE** button on the remote control to display the Source List. Use the **▲▼** buttons to select **PC** and then press the **OK** button to confirm.

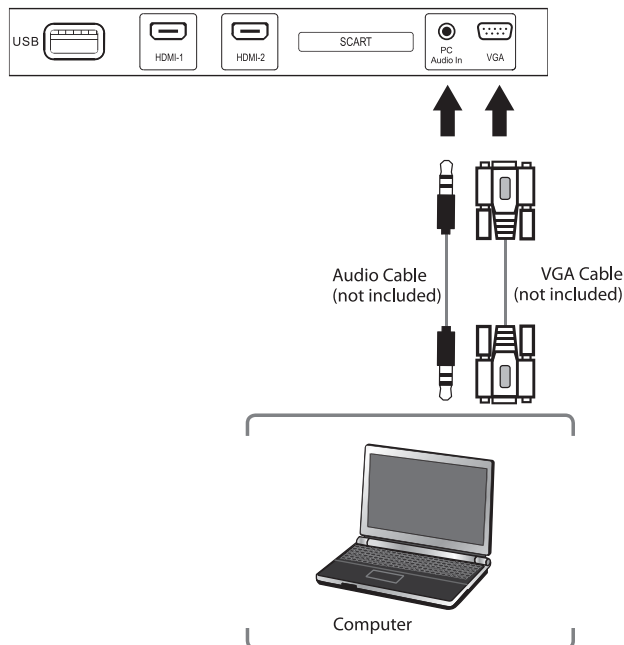

- The best resolution is 1366x768.
- If your computer is set to shut down after a few minutes of idle mode, the TV will also switch to standby due to no signal being received, this is to save energy. Press the **STANDBY** button at the right side of the TV when viewed from the front or the  button on the remote control to restart the TV.

Connecting an AV Device with a Component (YPbPr) Cable

1. Use a component cable to connect the TV's YPbPr input sockets to an external AV device's component output sockets.
2. Use an AV cable to connect the TV's AUDIO(L/R) input sockets to the external AV device's component audio output sockets. (Audio Left = white, and Audio Right = red)

Component port on the TV	Y	Pb	Pr
Video output ports on DVD player	Y	Pb	Pr
	Y	Cb	Cr

3. Plug the connected devices into the mains socket before switching on the **POWER SWITCH** which is located at the rear of the TV.
4. Press the **STANDBY** button at the front right side of the TV or the  button on the remote control to turn on your TV.
5. Press the **SOURCE** button at the front right side of the TV or the **SOURCE** button on the remote control to display the **Source List**. Use the **▲▼** buttons to select **YPbPr** and then press the **OK** button to confirm.

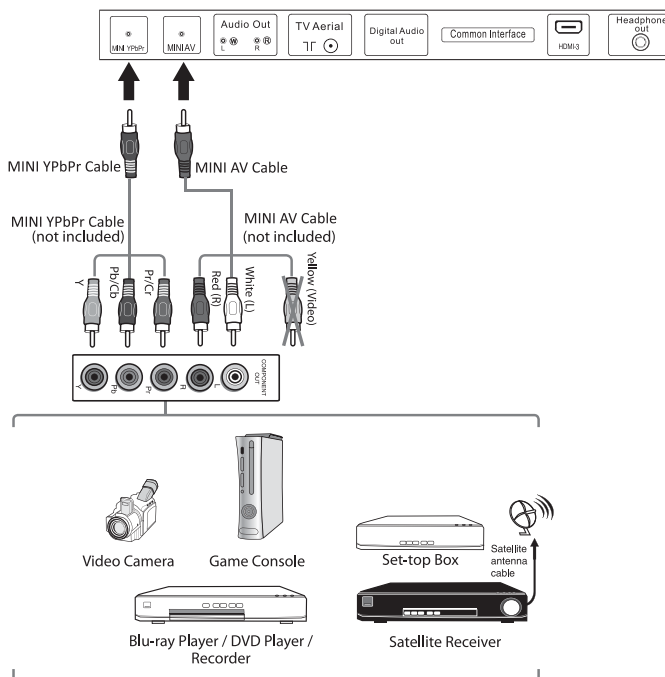

Connecting an AV Device with a SCART Cable

1. Use a SCART cable to connect the TV's SCART input socket to an external AV device's SCART output socket.
2. Plug the connected devices into the mains socket before switching on the **POWER SWITCH** which is located at the rear of the TV.
3. Press the **STANDBY** button at the front right side of the TV or the **⏻** button on the remote control to turn on your TV.
4. The TV will change the input source to **SCART** automatically once the AV device is switched on.

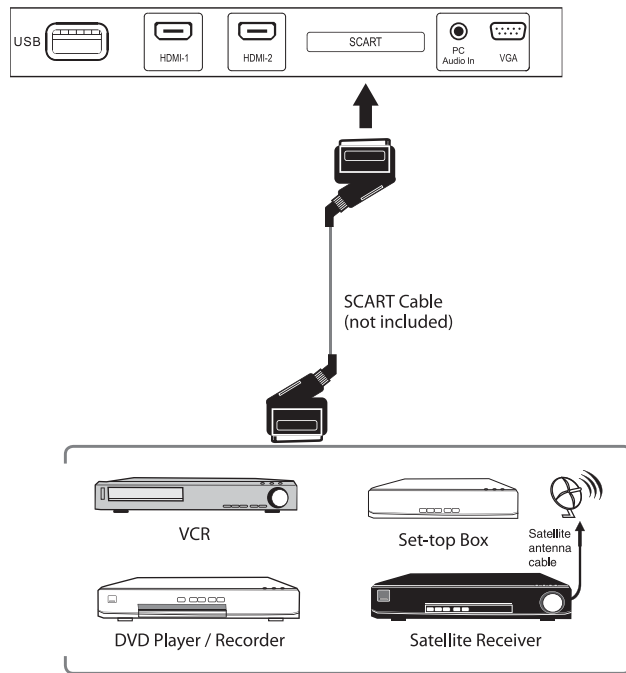

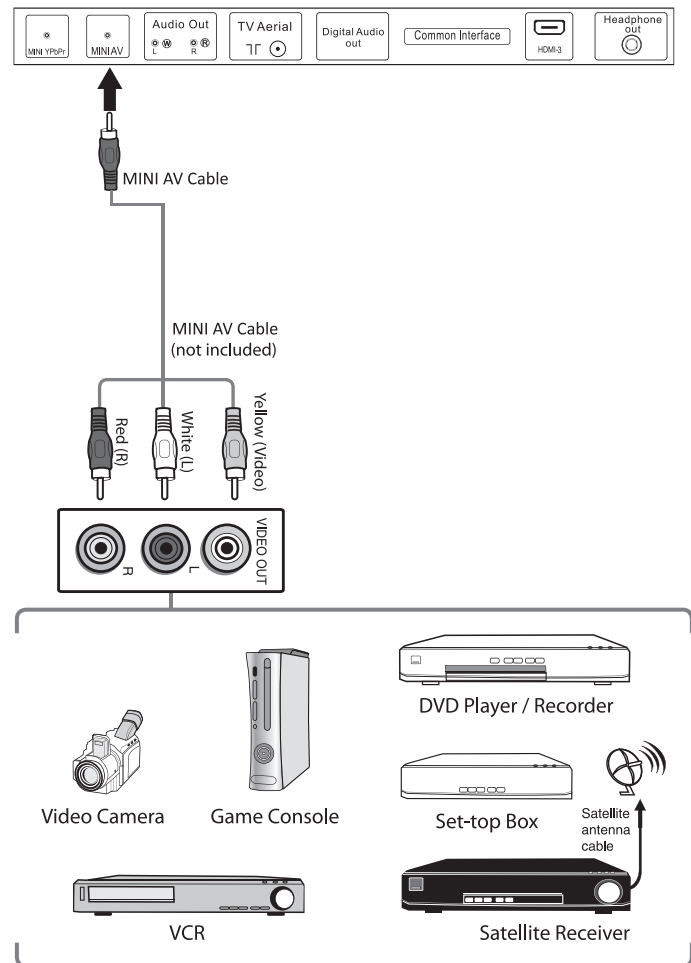

Connecting an AV Device with Composite Cable

1. Use an AV cable to connect the TV's AUDIO(L/R)/VIDEO input sockets to an external AV device's composite audio/video sockets. (Video = yellow, Audio Left = white, and Audio Right = red)
2. Plug the connected devices into the mains socket before switching on the **POWER SWITCH** which is located at the rear of the TV.
3. Press the **STANDBY** button at the front right side of the TV or the **⏻** button on the remote control to turn on your TV.
4. Press the **SOURCE** button at the front right side of the TV or the **SOURCE** button on the remote control to display the Source List. Use the **▲▼** buttons to select **AV** and then press the **OK** button to confirm.



Connecting a Digital Audio Receiver

For better sound quality, you may want to play the audio through your multi-channel audio receiver.

1. Use an audio cable to connect the TV's Digital Audio out socket to an external audio receiver's audio coaxial input socket.
2. Plug the connected devices into the mains socket before switching on the **POWER SWITCH** which is located at the rear of the TV.
3. Press the **STANDBY** button at the front right side of the TV or the  button on the remote control to turn on your TV.
4. Press the **SOURCE** button at the front right side of the TV or the **SOURCE** button on the remote control to display the Source List. Use the   buttons to select any desired input source and then press the **OK** button to confirm.



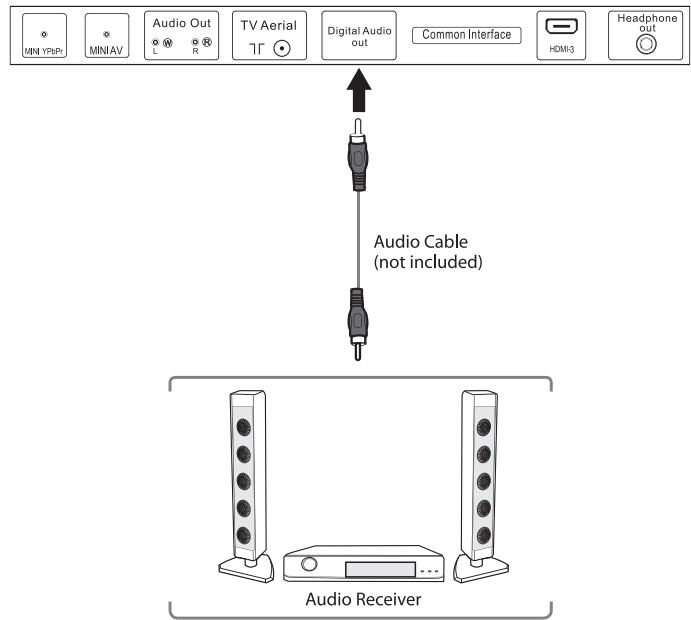

The TV's volume control will have no effect. You may control the audio level via the Audio Receiver.



Connecting an Audio Receiver

For better sound quality, you may want to play the audio through your multi-channel audio receiver.

1. Use an audio cable to connect the TV's AUDIO(L/R) input sockets to the external audio device's audio output sockets. (Audio Left = white, and Audio Right = red)
2. Plug the connected devices into the mains socket before switching on the **POWER SWITCH** which is located at the rear of the TV.
3. Press the **STANDBY** button at the front right side of the TV or the  button on the remote control to turn on your TV.
4. Press the **SOURCE** button at the front right side of the TV or the **SOURCE** button on the remote control to display the Source List. Use the   buttons to select any desired input source and then press the **OK** button to confirm.

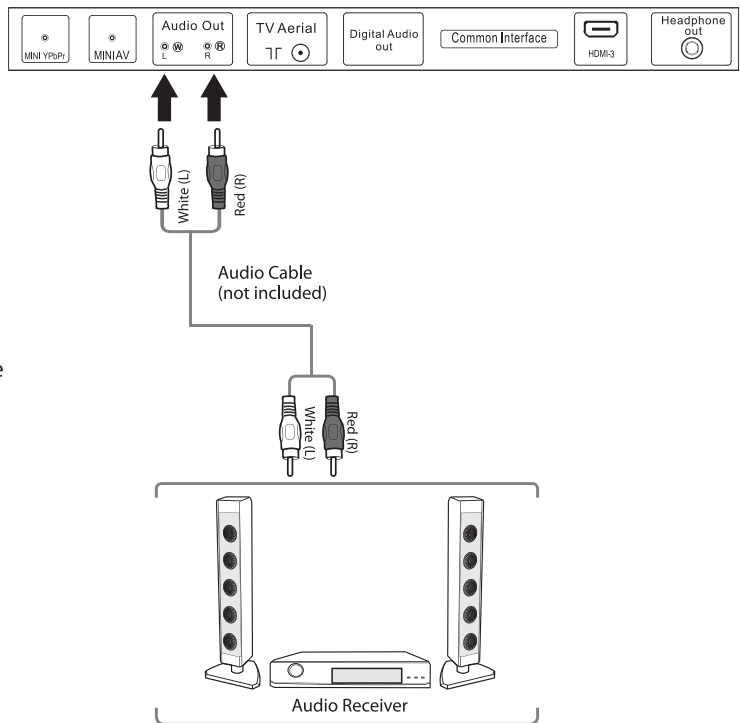

Connecting Headphones

Connect your headphones to the TV's Headphone out socket.

Before putting on headphones, turn the volume down then put the headphones on and slowly increase the volume until you reach a comfortable listening level.



Long-term exposure to loud music may cause hearing damage. It is best to avoid extreme volume when using earphones, especially for extended periods.

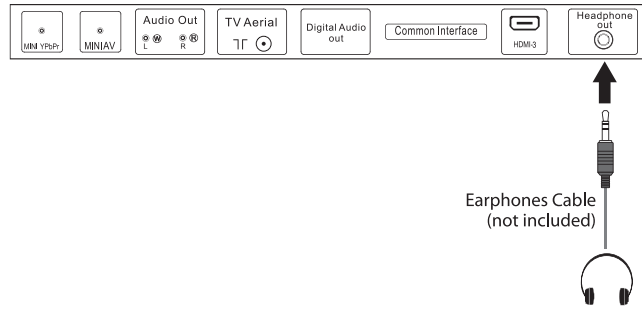

Turning the TV on for the First Time

1. Connect one end of the RF coaxial cable to the aerial socket on the wall and the other end of the cable to the Aerial socket at the rear bottom of your TV.



Do not connect the TV to the mains supply until you have completed all the connections.

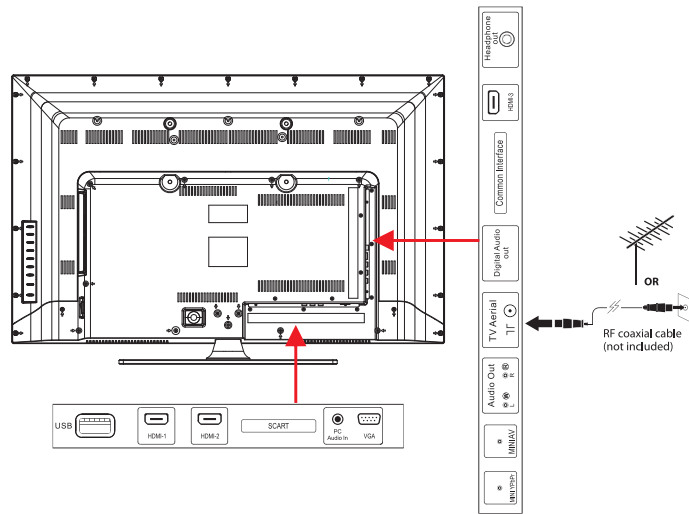

2. Connect the mains cable to the mains socket after you have completed all the connections

3. Switch on the **POWER SWITCH** which is located at the rear of the TV. At this stage, the TV switches to standby mode. The red LED indicator will illuminate on the front panel of the TV.

4. In standby mode, press the **STANDBY** button on the TV or the  button on the remote control to turn the TV on. The LED indicator will change from red to green.



The **STANDBY** button is located on the front right side of the TV.

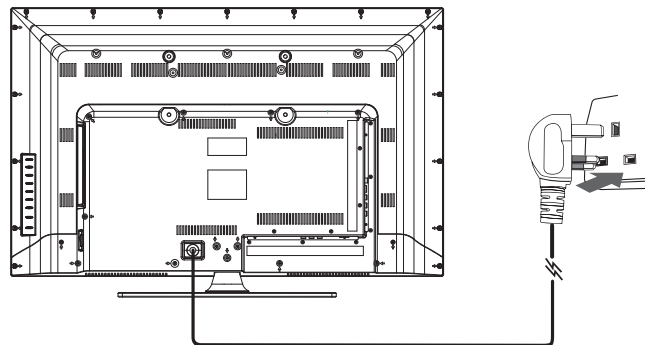

- Always disconnect the TV from the mains socket when not in use for a long period of time.
- The **STANDBY** button at the front right side of the TV or the  button on the remote control is only used for switching the TV into standby, it does not disconnect the TV from the mains power. To completely disconnect the mains power, please remove the mains cable from the mains socket.

- The first time you turn the TV on, it will go straight into the **First Time Installation** menu.

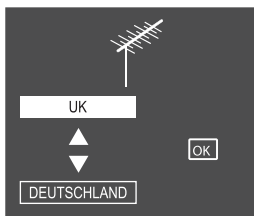

- Channel tuning will commence. This operation may take up to 10 minutes. The display will show the progress of the tuning and the number of channels found.
- If you want to skip the ATV tuning, press the **Menu** button to interrupt the tuning half way. A pop-up screen will be displayed, press the **Left Arrow** button to select **YES** to confirm. You will then go straight to DTV tuning. You may repeat the above step if you also want to skip the DTV tuning. An installation reminder will appear the next time you turn on the TV.
- After tuning is complete, the channels are arranged and stored in the broadcaster's preset order. and to select preview mode.

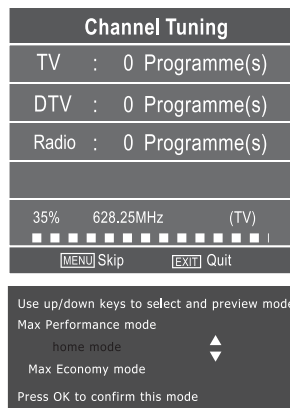

Selecting the Input Source

- Press the **Source** button at the front right side of the TV or the **Source** button on the remote control to display the Input source list.
- Press the **Up/Down Arrow** buttons to select the input source that you want: DTV/ ATV / SCART/YPBPR/DVD/PC/HDMI1/HDMI2/HDMI3/AV/USB.
- Press the **OK** button to confirm your selection. If you do not press the **OK** button to confirm, the TV will automatically confirm the selected input source within 4 seconds.



In DTV mode, press the **TV** button to switch to TV / digital radio channels directly.



Channel Selection

- Press the **CH+ / -** buttons at the front right side of the TV or on the remote control repeatedly or the **0-9** buttons on the remote control to select the channel.



Alternative

Press the **OK** button to enter the **Channel List**. Then use the **Up/Down Arrow** buttons to highlight and select the channel. Press the **OK** button to view the selected channel.

- If a blocked channel is selected, the password screen will be displayed. Press the **0-9** buttons to enter the password, the channel will then be unlocked (refer to page 27 for details on **Block Channel**).
- Press the **Return** button to return to the previously viewed channel.

Display Channel Information

- Press the **Info** button to view the current information.

Volume Adjustment

- Press the **VOL+** or **-** button at the front right side of the TV or on the remote control to adjust the volume.
- If you wish to switch the sound off, press the **Mute** button. Press the **Mute** button again or the **VOL+** or **-** button to resume audio listening.

Channel Setting (TV, DTV or Radio Mode)

Auto Tuning (DTV / ATV mode)

Use this to automatically find and store all available channels. This is normally recommended if some channels have been added or removed by the broadcaster or if you have moved house.

1. Press the **Menu** button to select the **CHANNEL** menu .

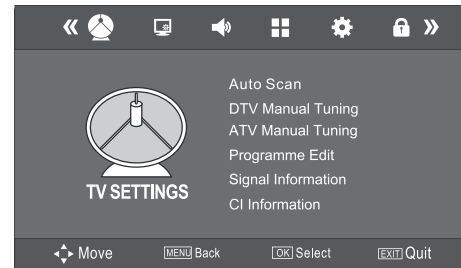

2. Press the **▲▼** buttons to select **Auto Tuning** and then press the **OK** button.

(ATV mode)

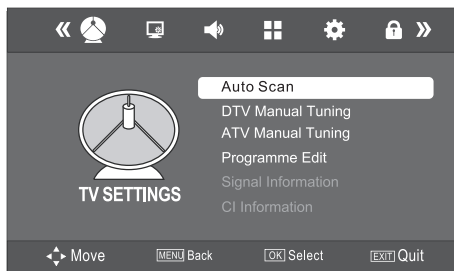

(DTV mode)

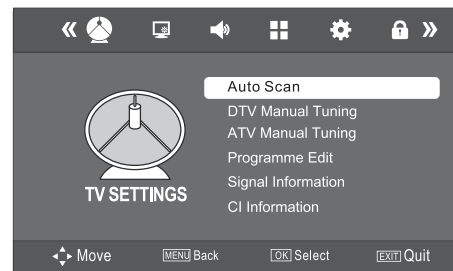

3. In the **Tune Type** menu, press the **◀▶** buttons to select **ATV / DTV / ATV +DTV**. Press the **▼** button and then press the **▲◀▶▼** buttons to select the country where you will operate the TV. Press the **OK** button to confirm.

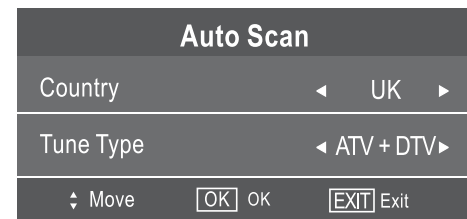

4. Channel tuning will commence. This operation may take up to 10 minutes. The display will show the progress of the tuning and the number of channels found.
5. If you want to skip the DTV tuning, press the **Menu** button to interrupt the tuning half way. A pop-up screen will be displayed, press the **◀** button to select **YES** to confirm. You will then go straight to ATV tuning. You may repeat the above step if you also want to skip the ATV tuning. An installation reminder will appear the next time you turn on the TV.
6. After tuning is complete, the channels are stored and arranged in a preset order.

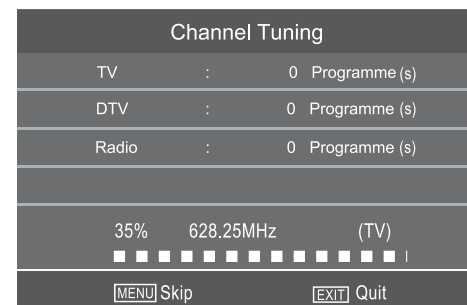

ATV Manual Tuning (ATV mode)

Allows you to make manual fine tuning adjustments if the channel reception is poor under ATV mode.

1. Press the **Menu** button to select the **CHANNEL** menu. .
2. Press the **▲▼** buttons to select **ATV Manual Tuning** and then press the **OK** button.
3. The ATV Manual Tuning screen will pop up. Use the **▲▼** buttons to select the following options and the **◀▶** buttons to adjust the setting.

Storage To	Storage the current channel number.
System	Selects the colour system: Auto / SECAM / PAL Selects the sound system: DK / I / BG.
Current CH	Displays the current channel number.
Search	Press the ◀▶ buttons to start the manual tuning.
Fine-Tune	Press the ◀▶ buttons to make manual fine tuning adjustments.

4. After finishing the manual tuning adjustment of a channel, press the **Menu** button to save your channel before tuning the next channel.
5. Press the **↵ Exit** button to exit the menu.

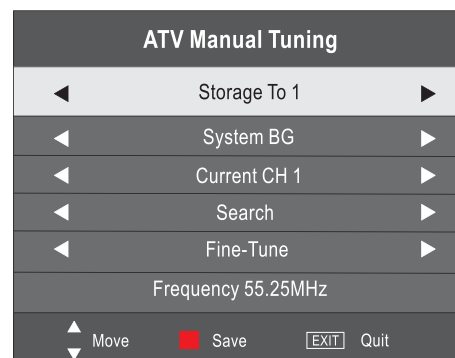
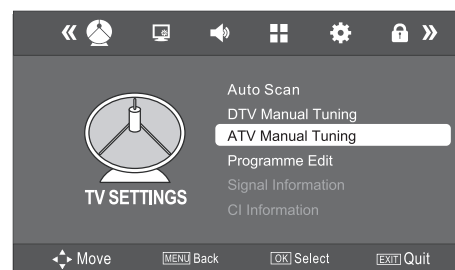

DTV Manual Tuning (DTV mode)

Allows you to make manual fine tuning adjustments of the channel under DTV mode.

1. Press the **Menu** button to select the **CHANNEL** menu.
2. Press the **▲▼** buttons to select **DTV Manual Tuning** and then press the **OK** button.
3. The DTV Manual Tuning screen will pop up. Press the **◀▶** buttons to select the desired UHF channel and then press the **OK** button to commence the search of that channel. When the signal has been tuned, the picture and signal strength will be displayed on the screen.
4. Press the **Menu** button to return back to the main menu.
5. Press the **↵ Exit** button to exit the menu.

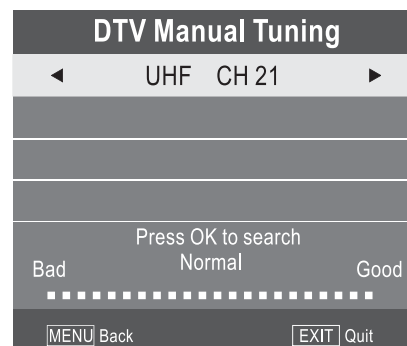
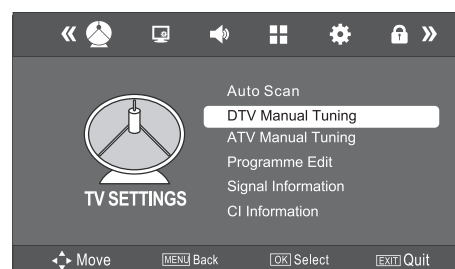

Programme Edit (ATV Mode)

Allows you to edit TV programmes in the Channel List.

1. Press the **Menu** button to select the **CHANNEL** menu.
2. Press the **▲▼** buttons to select **Channel Edit** and then press the **OK** button.
3. A Channel Edit screen will pop up. Press the **▲▼** buttons to select the programme you want to edit.
 - a. **Delete**
Press the **RED** button to delete the selected channel.
 - b. **Move**
Press the **YELLOW** button and then press the **▲▼** buttons to move to the selected channel. Press the **YELLOW** button or the **OK** button to confirm.
 - c. **Skip**
Press the **BLUE** button to select the channels that you want to skip when you are selecting channels. Press the **BLUE** button again to undo it.
 - d. **Rename**
Press the **GREEN** button to rename the selected channel. Press the **▲▼** buttons to select the characters to represent the station name. Press the **◀▶** buttons to move to the next character and then press the **OK** button to confirm the new name.
4. Press the **Menu** button to return back to the main menu.
5. Press the **↵ Exit** button to exit the menu.

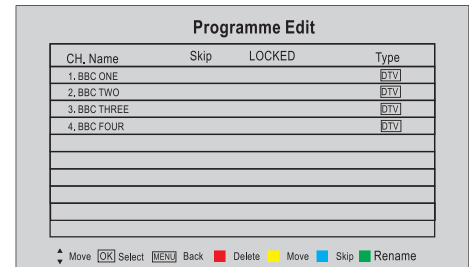
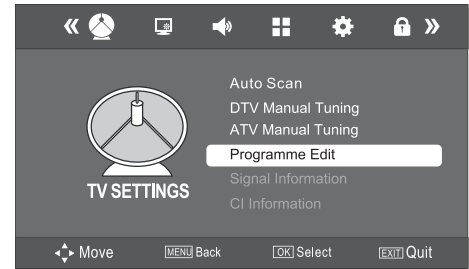

Programme Edit (DTV Mode)

Allows you to edit TV programmes in the Channel List.

1. Press the **Menu** button to select the **CHANNEL** menu.
2. Press the **▲▼** buttons to select **Programme Edit** and then press the **OK** button.
3. A Programme Edit screen will pop up. Press the **▲▼** buttons to select the programme you want to edit.
 - a. **Delete**
Press the **RED** button to delete the selected channel.
 - b. **Skip**
Press the **BLUE** button to select the channels that you want to skip when you are selecting channels. Press the **BLUE** button again to undo it.
4. Press the **Menu** button to return back to the main menu.
5. Press the **↵ Exit** button to exit the menu.

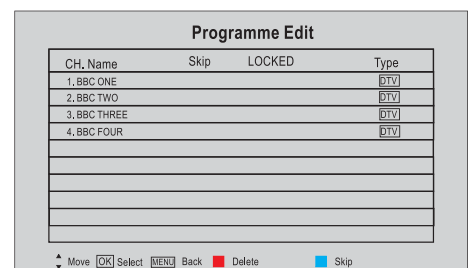
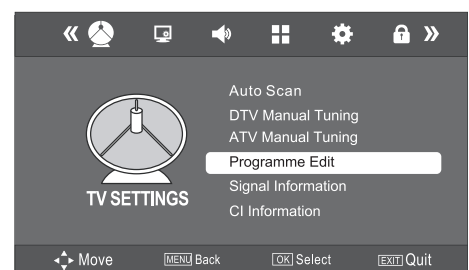

Signal Information (DTV Mode)

Allows you to view the signal information.

1. Press the **Menu** button to select the **CHANNEL** menu.
2. Press the **▲▼** buttons to select **Signal Information** and then press the **OK** button to view the signal information.

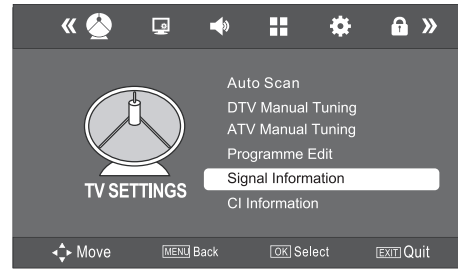

3. Press the **Menu** button to return to the previous menu.
4. Press the **Exit** button to exit the menu.

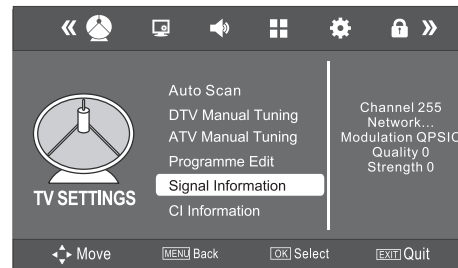

CI (Common Interface) (DTV Mode)

The common interface allows the use of a Common Access Module to enable you to view scrambled (pay to view) services. These services are provided by TopUp TV (UK only) and others. The Common Access Module and viewing card can be obtained from the service provider.



Do not repeatedly insert or remove the Common Access Module as this may damage the interface and cause a malfunction.

This feature is not available in all countries.

To insert the Common Access Module

1. Before you insert the Common Access Module, ensure that the TV is switched off and the viewing card is inserted **in accordance with the Service Provider's instructions**.
2. Insert the Common Access Module into the slot. Flip the Common Access Module to another side and try again if you feel resistance.
3. Switch the TV on.

To remove the Common Access Module

1. Before you remove the Common Access Module, ensure that the TV is switched off.
2. Pull the Common Access Module from the slot.
3. Switch the TV on.

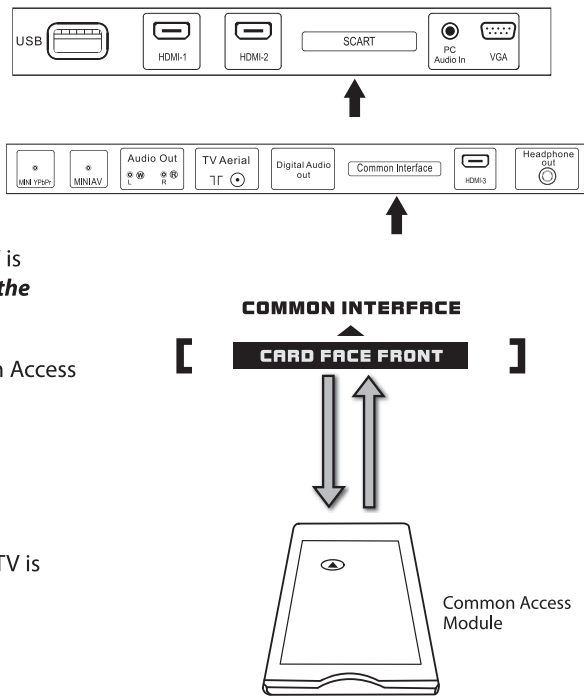

To view the module information

1. Press the **Menu** button to select the **CHANNEL** menu.
2. Press the **▲▼** buttons to select **CI Information** and then press the **OK** button.
3. A CI Information Main menu will pop up. Press the **▲▼** buttons to display the module information, smart card information, language, software download. Press the **OK** button to confirm.
4. Press the **Menu** button to return to the previous menu. Press the **← Exit** button to exit the menu.

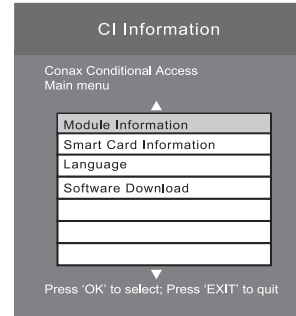
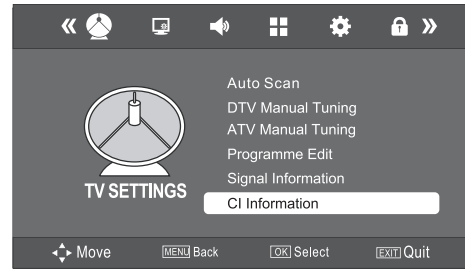

This screen is for illustration only.

Software Update(USB) (DTV mode)

1. Download the software to the usb device, then insert the usb device to the unit.
2. Press the **Menu** button to select the **CHANNEL** menu.
3. Press the **▲▼** buttons to select **Software Update(USB)** and then press the **OK** button to update software .
4. When the updating is completed, the unit will be reset to standby mode.

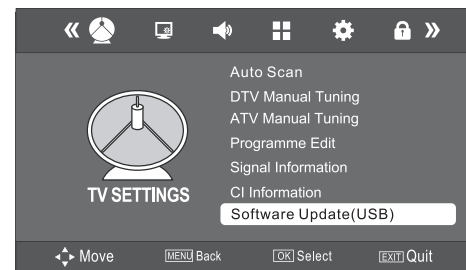

Picture Setting

Allows you to set your preferred picture mode.

1. Press the **Menu** button and then press the ◀▶ buttons to select the **PICTURE** menu.
2. Press the ▲▼ buttons to select the following picture options and then press the **OK** button.

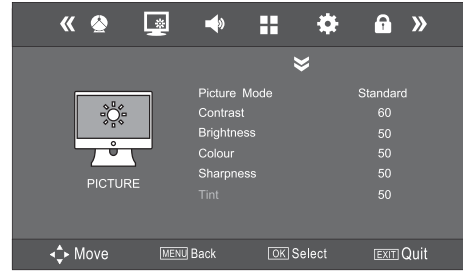

Picture Mode Press the ▲▼ buttons to cycle among picture mode: Dynamic / Standard / Mild / User and then press the **OK** button to confirm.



Alternative

You may press the **P** button once and then press the ◀▶ buttons to select the picture mode directly.

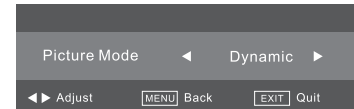

Contrast Press the ◀▶ buttons to adjust the difference between light and dark levels in the picture. (for Personal mode)

Brightness Press the ◀▶ buttons to increase or decreases the amount of white in the picture. (for Personal mode)

Colour Press the ◀▶ buttons to control the colour intensity (for Personal mode)

Sharpness Press the ◀▶ buttons to adjust the level of crispness in the edges between light and dark areas of the picture. (for Personal mode)

Tint (For NTSC format) Press the ◀▶ buttons to adjust the balance between red and green levels. (Tint is only available for NTSC signal input via the SCART or AV IN.)

Colour Temperature Press the ▲▼ buttons to cycle among colour temperature: Cool/ Medium / Warm /User and then press the **OK** button to confirm. Adjusts the colour components independently to achieve a warm or cool. (for Personal mode)

- **Cold:** Increases blue tint
- **Medium**
- **Warm:** Increases red tint
- **User**

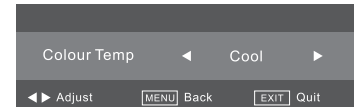

Red: Controls the red colour of the picture.

Green: Controls the green colour of the picture.

Blue: Controls the blue colour of the picture.

Aspect Ratio: Choose from 4:3, 16:9, Zoom1, Zoom2 and Panorama.

Noise Reduction Press the ▲▼ buttons to select to reduce the noise level of the connected device: Off / Low / Middle / High / and then press the **OK** button to confirm.

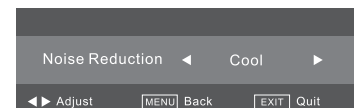

Sound Setting

Allows you to select an audio-enhancement technique.

1. Press the **Menu** button and then press the ◀▶ buttons to select the **SOUND** menu.
2. Press the ▲▼ buttons to select the following sound options and then press the **OK** button.

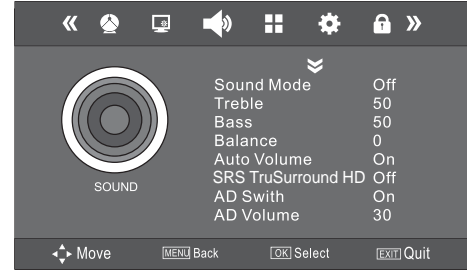

Sound Mode	Press the ▲▼ buttons to select an audio-enhancement technique: Standard / Music / Movie / Sports / User and then press the OK button to confirm.
Treble	Press the ◀▶ buttons to control the relative intensity of higher pitched sounds. (for Personal mode)
Bass	Press the ◀▶ buttons to control the relative intensity of lower-pitched sounds. (for Personal mode)
Balance	Press the ◀▶ buttons to adjust the relative volume of the speakers in a multiple speaker system.
Auto Volume	Press the ◀▶ buttons to turn on / off the auto volume. Select On to automatically control the volume. (e.g. advertisements tend to be louder than the programmes)
SRS TruSurround HD	Press the ◀▶ buttons to turn on / off the surround sound function by selecting "On" or "Off".
AD Switch (For DTV mode)	<p>Audio Description is an auxiliary audio function that provides an additional audio track for visually challenged persons. This function handles the Audio Stream for the AD (Audio Description), when it is sent along with the main audio from the broadcaster.</p> <ul style="list-style-type: none"> • Set to "Off" for normal broadcasting sound coming out from speakers. • Set to "On" to activate the description sound track if available. The availability of Audio Description sound track is indicated by the visually impaired icon "V.I." in the information banner.
AD Volume	When the AD Switch Set to " Off ", this function disavailable. When the AD Switch Set to " On ", you can press ◀▶ buttons to adjust the AD Volume .

3. Press the **Menu** button to return to the previous menu. Press the ← **Exit** button to exit the menu.

Stereo / Dual Sound Reception (ATV Mode)

When a programme is selected, press the **S** button twice and then press the ◀▶ buttons to select **Mono / Nicam Stereo** for the selected station.

Broadcast	On Screen Display
Mono	MONO
Stereo	NICAM STEREO

Mono sound selection

If the stereo signal is weak in stereo reception, you can switch to mono by pressing the **S** button twice and then press the ◀▶ buttons to select **Mono / Nicam Stereo**. In mono reception, the clarity of sound is improved. To switch back to stereo, press the **S** button twice and then press the ◀▶ buttons to select **Mono / Nicam Stereo** again.

Speaker Sound Output Selection (DTV Mode)

While watching a DTV programme, you can press the **S** button to display the audio language list (only applicable when the TV programme has this feature).

Press the ▲▼ buttons to select an audio language or audio format if available and then press the ◀▶ buttons to select sound track between L/R (Stereo), L/L (Mono Left) and R/R (Mono Right). Press the **OK** button to confirm and exit.

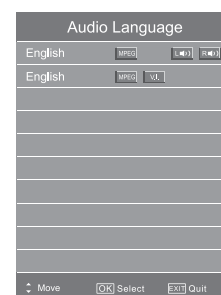

EXTRAS Setting

Allows you to adjust sleep timer, start recording, schedule list, recorded list, timer record, PVR file system and PC setup.

1. Press the **Menu** button and then press the ◀▶ buttons to select the **TIME** menu.
2. Press the ▲▼ buttons to select the following time options and then press the **OK** button.

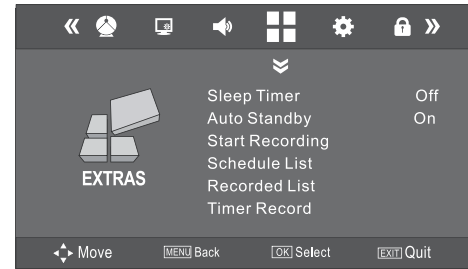

Sleep Timer

The sleep timer automatically switches the TV to standby after the preset time has elapsed. The clock will be set automatically when receiving a digital signal. Time must be set before using Sleep Timer function.

Press the ▲▼ buttons to select a period of time after which the TV automatically switches to standby mode: OFF / 10 / 20 / ... / 180 / 240 min and then press the **OK** button to confirm. The timer begins to count down from the number of minutes selected.



If you turn the TV off after setting the sleep timer, the sleep timer setting will be erased

Auto Standby

The unit will automatically switch to standby mode 4 hours after the last time the remote control was used.

A reminder screen will pop up and count down before the unit switches to standby mode.

If you want to operate the TV for a long period of time, turn off the auto standby function.

Press the **Menu** button to display the main menu. Press the ▲▼ buttons to select the **Time** option and then press the **OK** button. Press the ▲▼ buttons to select the **Auto Standby** option and then press the **OK** button to select "Off". Press the ← **Exit** button to exit the main menu.

Start Recording

Press OK button to enter the recording menu as below:



Note:

Press ■ button on the remote control or select Stop to stop record.

Schedule List

Press to display Schedule List.

Note: Delete any scheduled recordings out with the RED button.

Recorder List

Press OK button to enter the recorder list menu:

Press RED button to delete any programme.

Press Info button to display programme informations.

Note: You can press the SD1 button on the remote control to display the recorded list.



Timer Record

The TV will record the programme automatically according to your settings.

Press OK button to enter the timer record.

Start time: Select the record time begin

End time: Select the record time end

Press the OK button to save and exit the menu

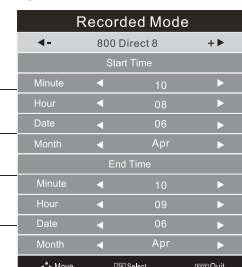

PVR File System (DTV Mode)

Allows you to select your preferences in the PVR File System.

1. Press the **Menu** button then press the ◀▶ buttons to select the **EXTRAS** menu.
2. Press the ▲▼ buttons to select **PVR File System** and then press the **OK** button.

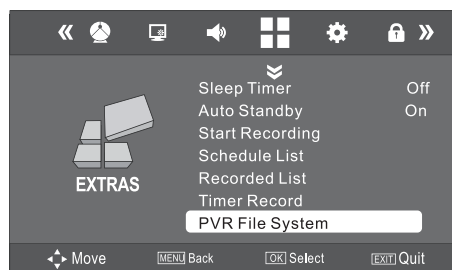

Select Disk Select the disk where you want to store your recorded content.

Check PVR File System Press the **OK** button, the system will now check your USB device's suitability for PVR. The system will show "**Checking**". Upon the completion the system will show either "**SUCCESS**" or "**FAIL**".

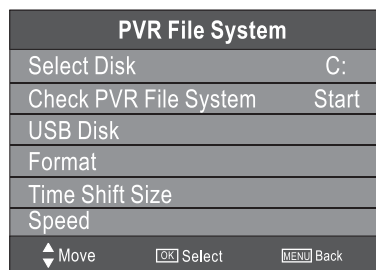

USB Disk If no USB storage device is connected, it will show "**No USB Device**". If the **Check PVR File System** has a "**SUCCESS**" it will show "**Pass**".

Format Press the **OK** button, a **File System Size** menu will pop-up. Press the ◀▶ buttons to select your preferred file type between **FAT32** and **Hi Speed FS**. If you select **Hi Speed FS**, press the ▼ button and then press the ◀▶ buttons to select your preferred file size. Press the **OK** button to confirm and then press the ◀ button to start formatting. This may take awhile depending on the size of your USB storage device.

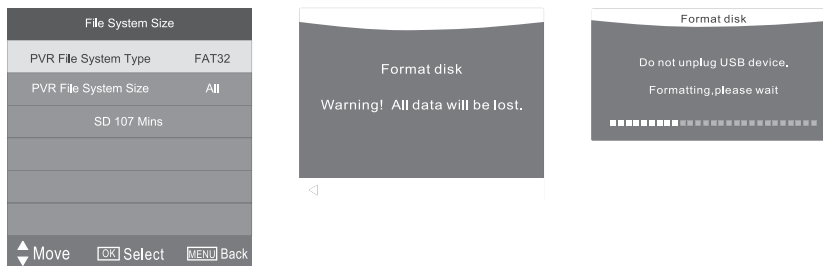

Time Shift Size After formatting the Time Shift Size menu will appear if you have selected **Hi Speed FS** in **PVR File System Type**. Press the ◀▶ buttons to select your preferred file size. Press the **OK** button to confirm. This option cannot be chosen if you have selected **FAT32** in **PVR File System Type**.



Speed This shows you the transfer rate of your USB storage device.

PC Setup (PC mode only) Press the **OK** button to enter the submenu to adjust the Horizontal/Vertical position or Size and Phase of the picture

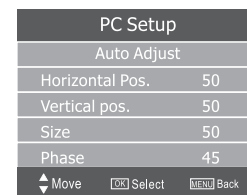

3. Press the **Menu** button to return to the previous menu. Press the → **Exit** button to exit the menu.

Options Setting

Allows you to adjust your OSD language, audio language, subtitle language...

1. Press the **Menu** button and then press the ◀▶ buttons to select the **EXTRAS** menu.

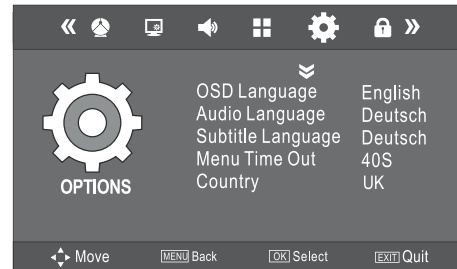

2. Press the ▲▼ buttons to select the following time options and then press the **OK** button.

OSD Language Press the ◀▶ buttons to select the menu language.

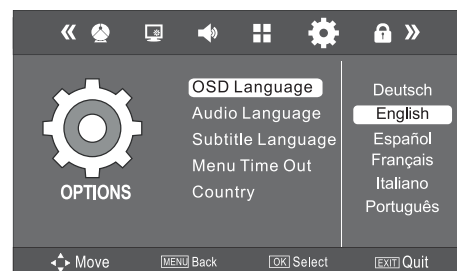

Audio Language Press the ◀▶ buttons to select the audio language.
(DTV mode only)

Subtitle Language Press the ◀▶ buttons to select the subtitle language.
(DTV mode only)

Menu Time Out Press the ◀▶ buttons to select the menu display time on screen.

Country This function is disabled.

Restore Settings Press OK button to enter the submenu (show as right)
Press the ◀ button to select **"Yes"**. The TV will return to the first time installation menu.
Press the ▶ button to select **"No"** to cancel and return to the main menu.

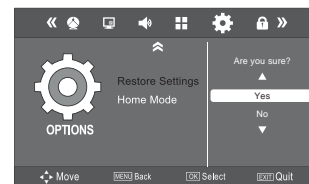

Home Mode Press the OK buttons to select the home mode.

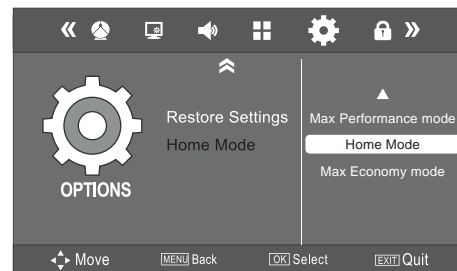

3. Press the **Menu** button to return to the previous menu. Press the ← **Exit** button to exit the menu.

Lock Setting

To access the **LOCK** menu, you must enter the password. Enter the default password "0000" for first time use. To change the password, please refer to "Set Password".

Lock System

The Lock System is designed to prevent accidental retuning of the TV / losing channels and prevent children watching unsuitable programmes.

The Lock System must be set to On for this function to operate. If the Lock System is set to On, a valid password must be entered when you access Auto Tuning / Manual Tuning / Restore Factory Default.

1. Press the **Menu** button then press the ◀▶ buttons to select the **LOCK** menu.



2. Press the ▲▼ buttons to select **Lock System** and then press the **OK** button.

3. Use the **0-9** buttons to input a 4-digit password to enter the **LOCK** menu.



- The default password is "0000".
- If you change the password, be sure to remember the new password! If you forget the new password, press the master password "8899".

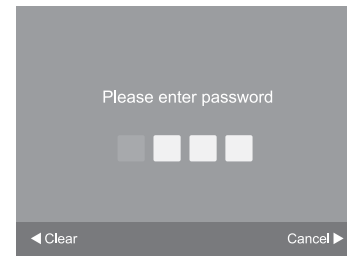

4. Press the ▲▼ buttons to select **Lock System** and then the **OK** buttons to select **On / Off**.
If the Lock System is set to On, a valid password must be entered when you access Auto Tuning / Manual Tuning / Channel Edit / First Time Installation / Restore Factory Default.
5. Press the **Menu** button to return to the previous menu. Press the ← **Exit** button to exit the menu.

Set Password

1. Press the **Menu** button and then press the ▲▼ buttons to select the **LOCK** menu and then press the **OK** button.



2. Press the ▲▼ buttons to select **Set Password** and then press the **OK** button.

3. Use the **0-9** buttons to input the old password and then input the new 4-digit password. Re-enter new password for confirmation.



- The default password is "0000".
- If you change the password, be sure to remember the new password! If you forget the new password, press the master password "8899".

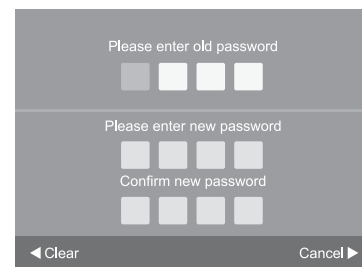

4. Press the **Menu** button to return to the previous menu. Press the ← **Exit** button to exit the menu.

Lock Channel

Block Channel is designed to prevent children watching unsuitable programmes.

1. Press the **Menu** button then press the ◀▶ buttons to select the **LOCK** menu.
2. Press the ▲▼ buttons to select **Lock System** and then press the **OK** button.
3. Use the **0-9** buttons to input a 4-digit password to enter the **LOCK** menu and then press the **OK** button to turn the Lock System **On**.



- The default password is "0000".
- If you change the password, be sure to remember the new password! If you forget the new password, press the master password "8899".

4. Press the ▲▼ buttons to select **Lock Channel** and then press the **OK** button.
5. A Block Channel screen will pop up. Press the ▲▼ buttons to select a channel. Press the **GREEN** button on the remote control to lock or unlock the channel. Press the **GREEN** button again to unblock.
6. Press the **Menu** button to return to the previous menu. Press the ← **Exit** button to exit the menu.



When a channel is blocked, a valid password must be entered.

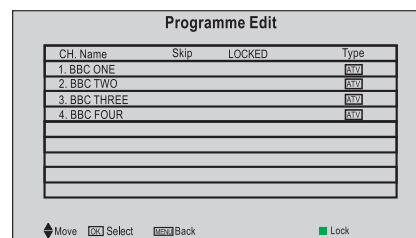

Parental Guidance

This function allows you to set up blocking schemes to block specific programmes and ratings. It operates according to information from the broadcasting station, therefore if the signal has incorrect information, this function will not operate.

This TV is programmed to remember which option it was last set to even if you switch the TV off.

1. Press the **Menu** button then press the ◀▶ buttons to select the **LOCK** menu.
2. Press the ▲▼ buttons to select **Lock System** and then press the **OK** button.
3. Use the **0-9** buttons to input a 4-digit password to enter the **LOCK** menu and then press the **OK** button to turn the Lock System **On**.



- The default password is "0000".
- If you change the password, be sure to remember the new password! If you forget the new password, press the master password "8899".

4. Press the ▲▼ buttons to select **Parental Guidance** and then press the **OK** button.
5. Press the ▲▼ buttons to select an age rating: Off, 4-18. Then press the **OK** button to confirm to return to the previous menu.
6. Press the **Menu** button to return to the previous menu. Press the ← **Exit** button to exit the menu.



When a programme is rated above the selected age rating, the programme will be blocked, a valid password must be entered.

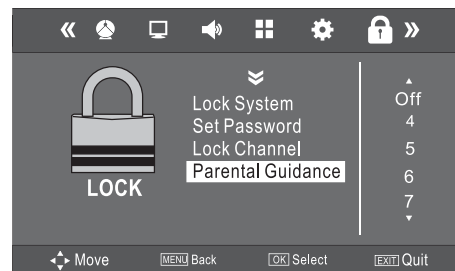

EPG (Electronic Programme Guide) (DTV Mode)

This system has an Electronic Programme Guide (EPG) to help you navigate through all the possible viewing options.

The EPG supplies information such as programme listings, start and end times for all available services. In addition, detailed information about the programme is often available in the EPG (the availability and amount of programme information will vary, depending on the particular broadcaster).

This function can be used only when the EPG information is broadcast by broadcasting companies.

The EPG displays the programme details for the next 7 days.

Switch On / Off EPG

1. Press the **GUIDE** button to switch on EPG.
2. Press the **GUIDE** button or the **← Exit** button again to switch off EPG and return to normal TV viewing.

Programme list by TIME

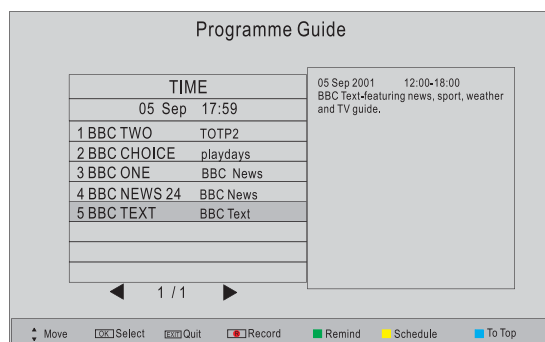

Programme list by CHANNEL

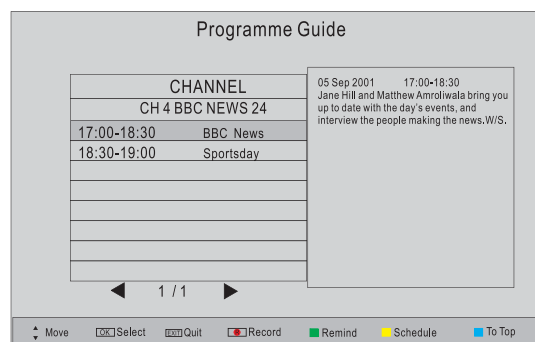

Select a Programme

Press the **▲▼** buttons to select the desired channel. Press the **OK** button to confirm.

Button Functions in a 7 Days Guide

Remote Control Button	Function
RED (Record)	<ul style="list-style-type: none"> • Timer Programming See page 50 for details on Timer Programming. • Press the RED button in the Schedule List to delete the selected preset reminder.
GREEN (Remind)	Press the GREEN button to display the remind menu, and set the time. When the programme starts the TV will automatically switch to this programme.
YELLOW (Schedule)	Press the YELLOW button to view the preset reminders or scheduled recordings in the Schedule List .
BLUE (To Top)	Press the BLUE button to return to and highlight the top of the table.
▲ or ▼	Press to select a channel.
◀ or ▶	Press to view the schedule of the previous / next day.
OK	Press to confirm and view the selected channel.
← Exit	Press to switch off the EPG.

Teletext (ATV Mode)

Teletext is a free service broadcast by some TV stations which gives up-to-the-minute information on news, weather, television programmes, share prices and many other topics. Using the Teletext control buttons you can view pages of information that are listed in the teletext index.

To Turn on Teletext Function



Make sure the TV channel you are watching transmits teletext.
"No Teletext" sign will show on the screen if teletext is not available.

In ATV mode, press the **TEXT** button to enter Teletext mode.

Press the **TEXT** button three times to exit and the TV will return to the channel you were watching.

To select a page of text

Find the number of the page in the index and enter it using the **0-9** buttons. The number of the page will appear on the top left corner of the screen.

The page counter will search for your page. When it finds it, the page will be displayed.

To move to the next page of text, press the **▲** button.

To move to the previous page, press the **▼** button.

Mix

To view a page of text while watching a TV programme, press the **TEXT** button twice. The text will be superimposed over the TV programme.

Fasttext

At the bottom of the teletext screen is a row of subject headings in red, green, yellow and blue.

The remote control has a row of colour buttons corresponding to the row of coloured subjects on the screen.

Pressing one of the colour buttons will take you directly to the page corresponding to the subject heading.

Digital Teletext (DTV Mode)

Digital teletext can access special digital teletext services and specific services which broadcast digital teletext. You will need to turn off **Subtitle Function** before using teletext.

Teletext within Digital Service

1. Press the **TEXT** button to display the teletext page. If no Teletext service is available, a "No Teletext" message will be displayed.
2. Press the **0-9** buttons to select a page number.
3. Follow the instructions on digital teletext and move onto the next step by pressing **OK**, **▲◀▶▼**, **RED**, **GREEN**, **YELLOW**, **BLUE** or **0-9** buttons etc.
4. To change digital teletext service, select a different service by pressing the **0-9** buttons or the **▲▼** buttons.



Alternative

You may press the **RED** button to the **TEXT** button to display the teletext information when you see a ● red logo displayed on the screen (e.g. BBC).

5. Press the **TEXT** button to exit.

Connecting a USB Storage Device

1. Switch off the TV before connecting any USB storage device.
2. Connect your USB storage device to the USB port of your TV.
3. Plug the connected devices into the mains socket before switching on the **POWER SWITCH** which is located at the rear of the TV.
4. Press the **STANDBY** button at the front right side of the TV or the **POWER** button on the remote control to turn on your TV.
5. Press the **SOURCE** button at the front right side of the TV or the **SOURCE** button on the remote control to display the Source List. Use the **▲▼** buttons to select **USB** and then press the **OK** button to confirm.

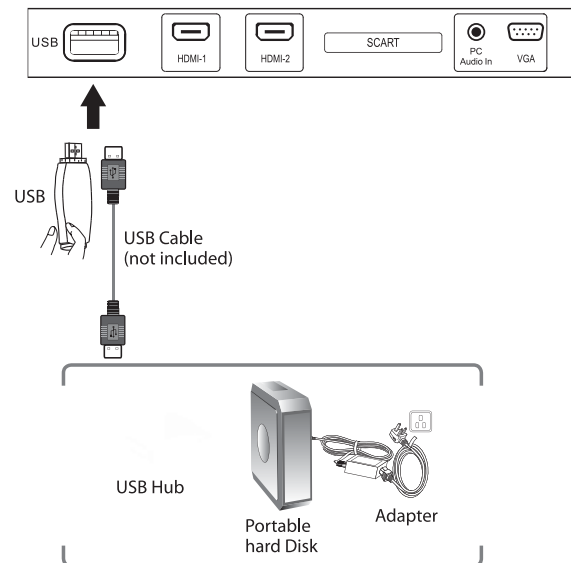

- If a hard disk is used, make sure its mains adapter is connected to the mains supply.
- If a USB hub is used, make sure its mains adapter is connected to the mains supply as the total current consumption may exceed 500mA.
- The maximum supported storage space of the hard disk is 1 TB.
- The file system only supports HiSpeed FS, FAT16, FAT32, NTFS formats (NTFS Compressed files are not supported).
- If you want to store the video streaming of a DTV programme, the transfer rate of the USB storage device must not be less than 5MB/s, otherwise the picture and sound of the programme will be affected and a warning statement will be shown on the screen. If this happens, please upgrade your USB storage device.
- The TV screen will be blank temporarily as it will take time to start up and stabilise the connected hard disk. This is normal and the starting time may vary depending on the brand and the memory size of the connected hard disk.
- Disconnect the USB storage device if it is not in use.

Multimedia Operation

Basic Operation

1). Press the SOURCE button on the remote control to display the input source menu, select the USB source with the ▼▲ buttons and press the OK button to enter the Multimedia menu below.

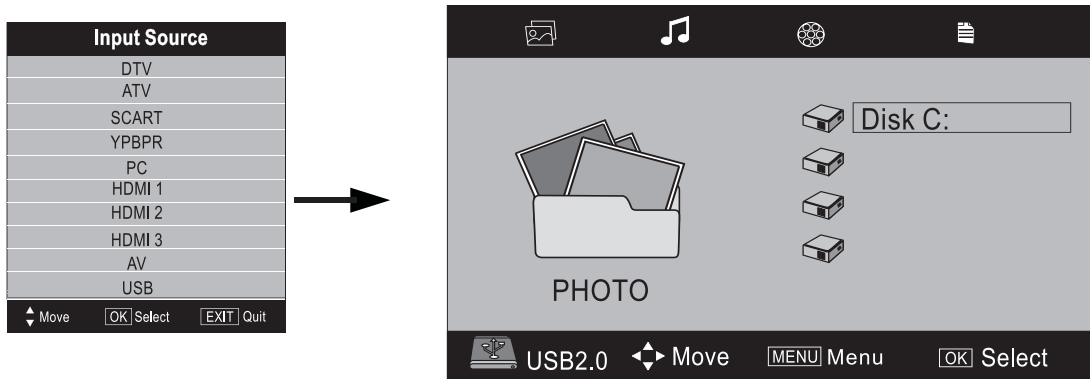

2). Insert the USB device, the name of the device will be displayed on the screen.

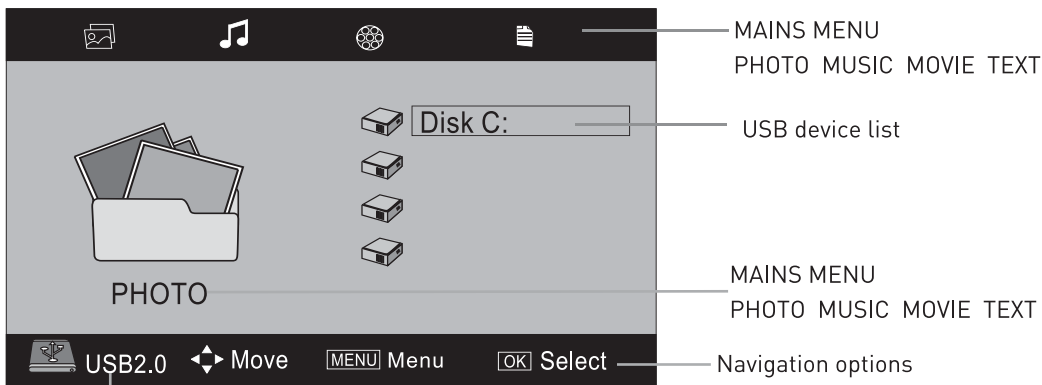

Information of the USB device

3). Press ◀/▶ button to select the files on the USB device (PHOTO, MUSIC, MOVIE, TEXT) to view or play.

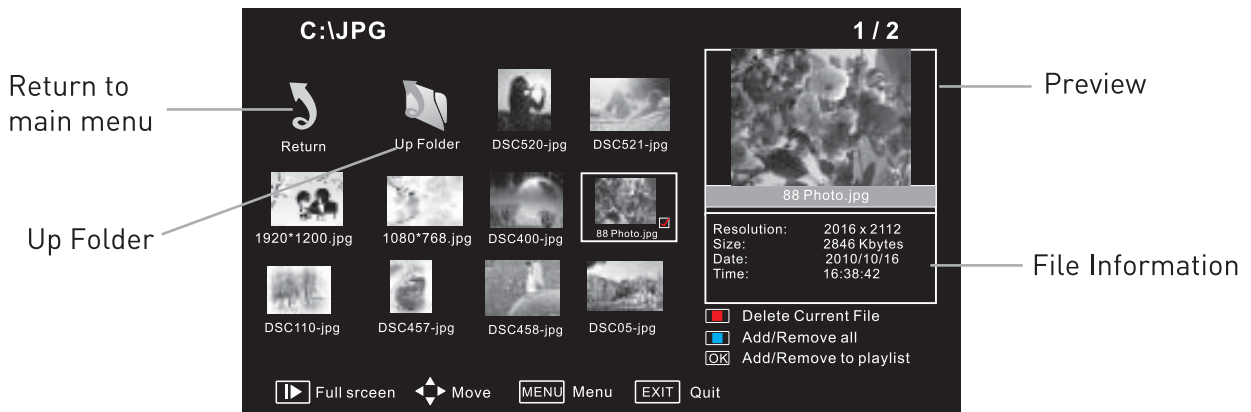

Press ◀/▶/▲/▼ buttons to select and the OK button to activate the file or open folder. Press ▶▶ button to play the files in full screen mode. When in full screen mode press the OK button to show the navigation option menu on the bottom of the screen or press ■ stop button to return to files.

1. Photo

Photo viewing



Press ◀/▶ buttons to select the option on the menu, and press the OK button to activate.

Repeat: Select the repeat mode from Repeat All, Repeat 1, Repeat None.

Music: Play/Pause the background music of your choice.

Playlist: Display the playlist on the screen and select the photo of your choice.

Info: Display the information of the file.

Rotate: Rotate the photo clockwise/counterclockwise.

Zoom In/Out: Zoom In/Out of your photos.

Move View: Move the photo in Zoom out mode.

2. Music

Listen to music

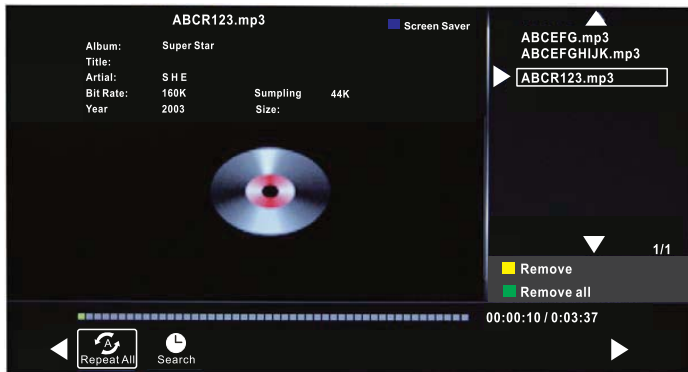

Press ◀/▶ buttons to select the option on the menu, and press the OK button to activate.

Press ▼/▲ buttons to select the music, and press the OK button to play.

Repeat: Select the repeat mode from Repeat All, Repeat 1, Repeat None.

Search: Program the music to play from the time you set.

Press the OK button to display the time table, and select the position with the ◀ ▶ ▼ ▲ buttons, set the time using the numeral buttons on the remote, select "OK" and press the OK button to search.

Screen Saver: Press the BLUE button to enter the Screen Saver mode, press again to exit.

Multimedia Operation (continued)

3. Movie

Watch a film



Press ◀/▶ buttons to select the option on the menu, and press OK button to activate.

Repeat: Select the repeat mode from Repeat All, Repeat 1, Repeat None.

Set A-B: Select and play the preferable part of the file by setting A and B at the beginning and end. Press OK button to cancel.

Playlist: Display the playlist on the screen.

Info: Display the information of the movie file.

Slow: Play the movies at slow speed, press ▶ button to cancel and resume at normal speed.

Step: Step quickly through the movie by using this option

Search: Program the movie form the time you set.

Zoom In/Out: Zoom In/Out of the movie screen.

Aspect Ratio: Select the aspect ratio of the on screen display.

Move View: View the film in Zoom out mode.

4. Text

View text files



Press ◀/▶ buttons to select the option on the menu, and press the OK button to activate.

Prev/Next page: Turn to previous/next page of the text.

Prev./Next: Turn to previous/next file.

Stop: Stop auto turning pages.

Music: Play/pause the background music of your choice.

Playlist: Display the playlist on the screen.

Info: Display the information of the text file.

Time Shift Function (DTV Mode)

This function allows the TV to virtually record the live viewing broadcast programme.



- Time Shift Mode and Recording functions may not work if the signal strength is weak.
- Stop the time-shift function before switching to another input source.



If the transfer rate of the USB storage device is too slow for recording or time shift function, a warning statement will be shown on the screen. If this happens, please upgrade your USB storage device.

During normal TV viewing, you may press the **▶** button to virtually pause the live viewing broadcast programme if you want to go out for a while (e.g. going to the bathroom / kitchen). "||" will show on the screen.



Alternative

Press the **OK** button to display the PVR Time Shift progress bar and then press the **◀▶** buttons to select "**▶ Play**" on the bar. Press the **OK** button to confirm.

When you have returned, press the **▶** button to play the missed broadcast programme. "**▶**" will show on the screen.

There may be a few seconds delay in video and sound when the unit starts to playback the missed broadcast programme. It will return to normal.



The 'PVR Time Shift Progress Bar'

- 1 Indicates the status of the currently displayed video (▶/||/◀▶/▶▶)
- 2 Indicates the time lagging behind the live broadcast (DVR reviewing)
- 3 Indicates the available recording time on your USB storage device
- 4 Indicates the current time

Using the Remote Control

You can shift playback to any point of the virtually recorded programme. The PVR Time Shift progress bar will be displayed on the screen for 15 seconds. Press the **OK** button to display the PVR Time Shift progress bar again.

▶	<ul style="list-style-type: none"> • During playback, press the ▶ button to display a still screen and then press the ▶ button again to resume playback. • During fast forward / fast backward state, press the ▶ button to return to normal playback.
◀▶ or ▶▶	<p>When playing,</p> <ul style="list-style-type: none"> • Press the ◀▶ button repeatedly to speed up ◀▶ x 2 / x 4 / x 8 / x 16. • Press the ▶▶ button repeatedly to speed up ▶▶ x 2 / x 4 / x 8 / x 16. • During fast forward / fast backward state, press the ▶ button to return to normal playback.
◀◀ or ▶▶	<ul style="list-style-type: none"> • Press the ▶▶ button to jump about 10% forward. • Press the ◀◀ button to jump about 10% back.
OK	During playback, press the OK button to display a still screen and then press the ▶ button again to resume playback.
■	If you want to exit the PVR Time Shift progress bar and return to the current live broadcast, press the ■ button and then press the ◀ button to confirm.

Recording DTV Programme onto a USB Storage Device

Use this function to record the DTV programme you are watching on the main screen and save them for future viewing.

Make sure that your connected USB storage device has enough available memory space.

1. Press the **R** button to record the programme that you are currently watching.



The recording progress bar will disappear after 15 seconds. To display the recording progress bar again, press the **OK** button or the **R** button

2. Press the **■ Stop** button to stop recording.



Recording will stop automatically when the disk is full.



Timer Programming

This function is used to perform scheduled recording.

1. Press the **GUIDE** button on the remote control. The **EPG** menu will appear.

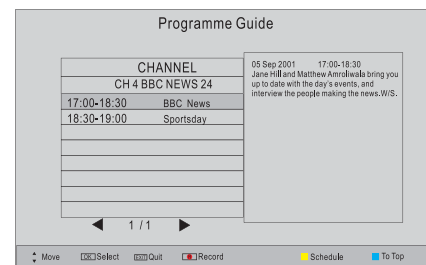

2. Press the **R** button on the remote control while on the selected programme, the **RECORDER** menu will be displayed. Press the **▲▼** buttons to select the settings in the **RECORDER** menu for the Channel, Start time, End time and Mode.

Start time	Press the ▲▼ buttons to select the Minutes / Hour / Month / Date and then press the ◀▶ buttons to adjust the start time.
(for Mode Once, Every Day, Weekly)	

End time	Press the ▲▼ buttons to select the Minutes / Hour / Month / Date and then press the ◀▶ buttons to adjust the end time.
(for Mode Once, Every Day, Weekly)	

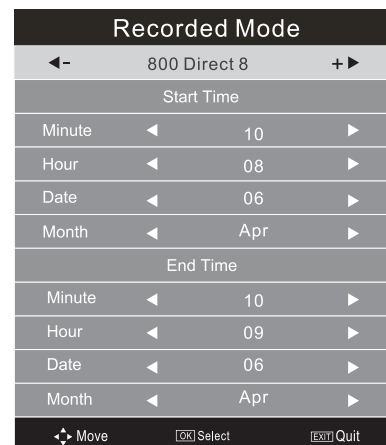

3. After finishing all the recorder adjustments, press the **OK** button to confirm your settings. A Timer Save Success screen will display.
4. The **Schedule List** will then be displayed with your preset reminders shown.
5. Press the **MENU** button to return to the EPG.
6. Press the **← Exit** button to exit EPG.



- When the preset time is reached, the TV will start recording automatically.
- If a programme recording starts when the TV is in standby mode, the LED indicator will alternately flash red and green.

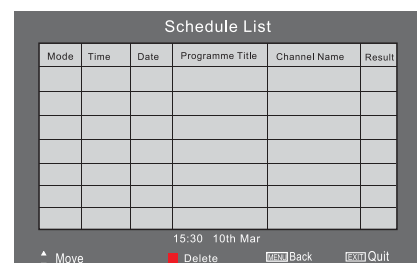

Play Recorded Programme

You can play a recorded programme from the recorded programme list or from a USB Storage Device.

1. Press the **SOURCE** button at the front right side of the TV or the **SOURCE** button on the remote control and then press the **▲▼** buttons to select the **USB** mode and then press the **OK** button.
2. Press the **◀▶** buttons to select **MOVIE** and then press the **OK** button.

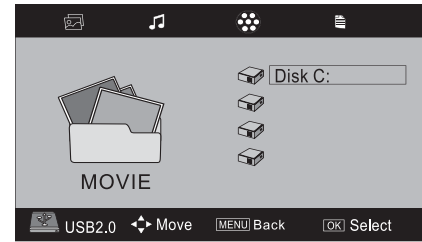

3. Press the **◀▶** buttons to select your storage device and then press the **OK** button.

4. Press the **▲◀▶▼** buttons to select the "MY PVR" folder and then press the **OK** button. Press the **▲◀▶▼** buttons to navigate in the "MY PVR" folder. Select your recorded programme and then press the **OK** button to view.



Maintenance

Careful and regular cleaning can prolong the life of your TV.



Be sure to Disconnect the mains cable from the mains socket before any cleaning.

1. Use a soft dry cloth to wipe away the dust from the screen and surfaces.
2. If the surfaces are extremely dirty, clean the TV with a cloth which has been dipped in a weak soapy water. Wring the cloth until it is almost dry, then use it to wipe the TV.
3. Ensure there is no excess water on the screen. Allow any water or dampness to evaporate before switching the TV on.

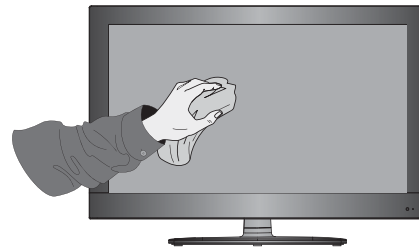

Never use alcohol, benzene, paint-thinner, cleaning fluid or other chemicals. Do not use compressed air to remove dust.

Hints and Tips

The following table contains various hints and tips to get the best performance from your TV.

The TV does not operate properly.	
The TV does not respond when pressing any buttons	<ul style="list-style-type: none">• The TV may freeze up during use. Disconnect the mains cable from the mains socket for a few minutes. Reconnect the mains cable and try to operate it again as usual.
TV cannot be switched on	<ul style="list-style-type: none">• Check that the TV is connected to the mains supply and the POWER SWITCH at the rear of the TV is switched on.• Make sure all connected AV devices are switched off before switching on your TV.
The remote control does not work	<ul style="list-style-type: none">• Check to see if there are any objects between the TV and the remote control causing an obstruction. Ensure that you are pointing the remote control directly at the TV.• Ensure that the batteries are installed with the correct polarity (+ to +, - to -).• Install new batteries.
Power is suddenly turned off	<ul style="list-style-type: none">• Check the power of the TV. The mains supply maybe interrupted.• Check if the sleep timer is set.• Check whether the Auto Standby is activated.
The video function does not work.	
No Picture & No Sound	<ul style="list-style-type: none">• Check whether the TV is switched on.• Try another channel. The problem may be caused by the broadcaster.
Picture appears slowly after switching on	<ul style="list-style-type: none">• This is normal, the image is muted during the TV startup process. Please contact your service centre, if the picture has not appeared after five minutes.
No or poor colour or poor picture	<ul style="list-style-type: none">• Adjust the settings in the PICTURE menu.• Try another channel. The problem may be caused by the broadcaster.• Check if the video cables are connected properly.
Horizontal / Vertical bar or picture shaking	<ul style="list-style-type: none">• Check for local interference such as an electrical appliance or power tool.
Poor reception on some channels	<ul style="list-style-type: none">• Station or cable channel may be experiencing problems, tune to another station.• Station signal is weak, reposition the aerial for better reception.• Check for sources of possible interference.
Lines or streaks in pictures	<ul style="list-style-type: none">• Check aerial (Change the position of the aerial.)
No pictures when connecting HDMI	<ul style="list-style-type: none">• Check if the input source is HDMI1 / HDMI2 / HDMI3.
Picture appears in wrong ratio	<ul style="list-style-type: none">• Adjust the Aspect Ratio settings in the SETUP menu.

The audio function does not work.	
Picture OK but no sound	<ul style="list-style-type: none"> • Press the VOL + / - buttons. • Sound muted? Press the M button. • Try another channel. The problem may be caused by the broadcaster.
No output from one of the speakers	<ul style="list-style-type: none"> • Adjust the Balance settings in the SOUND menu.
Unusual sound from Inside the TV	<ul style="list-style-type: none"> • A change in ambient humidity or temperature may result in an unusual noise when the TV is switched on or off and does not indicate a fault with the TV.
No sound when connecting HDMI	<ul style="list-style-type: none"> • Check if the input source is HDMI1 / HDMI2 / HDMI3.
Audio noise	<ul style="list-style-type: none"> • Keep the RF coaxial cable away from the other connected cables.
Password	
Lost password	<ul style="list-style-type: none"> • Select the Set Password setting in the LOCK menu, then enter the following master password "8899". The master password clears your previous password and allows you to enter a new password.
There is a problem in PC mode.	
The signal is out of range (Invalid format)	<ul style="list-style-type: none"> • Adjust the resolution, horizontal frequency, or vertical frequency.
Vertical bar or stripe on background & Horizontal Noise & Incorrect position	<ul style="list-style-type: none"> • Use Auto configure or adjust clock, phase, or H/V position.
Screen colour is unstable or single colour	<ul style="list-style-type: none"> • Check the signal cable. • Reinstall the PC video card.
FAQs (Frequently Asked Questions)	
Why have I lost some / all of my channels?	<ul style="list-style-type: none"> • It happens sometimes, if you have a weak signal. Usually it just means you'll need to rescan your digital box or TV. Don't worry, it's easy to do. And once you've done it, you should get all the Freeview channels available to you. If problems persist you may need to get your aerial checked. Talk to your retailer or contact your local aerial installer.
Why do I get 'blocking' on my digital picture?	<ul style="list-style-type: none"> • In most cases, blocking is caused by a reception problem – either the signal is too weak or there is some kind of interference. Talk to your retailer or contact your local aerial installer. • Blocking can also be caused by a digital signal that is too strong. If you are still experiencing blocking and the signal is strong, consult your local aerial installer for advice.
Can I watch Freeview using a portable set-top aerial?	<ul style="list-style-type: none"> • Some, but only a few, homes may be able to use a set top aerial. However, for a much better reception, we strongly recommend that you use a rooftop aerial. • If you do not have access to a rooftop aerial – for example, if you rent a flat and the aerial is the responsibility of your landlord, or if you're using a second TV in the bedroom and don't want the hassle and expense of using extension cables, a set – top aerial may be your only option.
What type of aerial do I need?	<ul style="list-style-type: none"> • If you are installing a new aerial, we recommend a wideband rooftop aerial rather than a loft aerial. Loft aerials generally receive a weaker digital signal and are more likely to get interference from other electrical devices in the home. We suggest you have an aerial survey done before getting an aerial upgrade. • Talk to your retailer or contact your local aerial installer.

Display Modes

The screen resolution has been optimised during production for the display modes listed below.

YPbPr Mode

Resolution	Vertical Frequency (Hz)	Aspect Ratio
480i: 720 x 480	60	4:3 / 16:9 / Zoom1 / Zoom2
480P: 720 x 480		
576i: 720 x 576	50	
576P: 720 x 576		
720P: 1280 x 720	50	
	60	
1080i: 1920 x 1080	50	
	60	
1080P: 1920 x 1080	50	
	60	

PC Mode

Please check the display settings of your computer before connecting to the TV. If the display setting of your computer does not match the TV, there may be no video.

Resolution	Vertical Frequency (Hz)	Aspect Ratio
640 x 480	60	4:3 / 16:9
	72	
	75	
800 x 600	60	
	72	
	75	
1024 x 768	60	
	70	
	75	
1366x768	60	

HDMI Mode

Resolution	Vertical Frequency (Hz)	Aspect Ratio
480i: 720 x 480	60	4:3 / 16:9 / Zoom1 / Zoom2 / Just Scan
480P: 720 x 480		
576i: 720 x 576	50	
576P: 720 x 576		
720P: 1280 x 720	50	
	60	
1080i: 1920 x 1080	50	
	60	
1080P: 1920 x 1080	50	
	60	

Specifications

Model	C32E69DVB-DLED
Panel System	32 inch DLED Panel
Display Resolution	1366 pixels (horizontal) x 768 pixels (vertical)
Television System	PAL I / BG / DK / SECAM BG/DK
Brightness	300cd/m ²
Contrast Ratio	4000:1
Power Source	100-240V~50/60Hz
Energy Efficiency Class	A
Screen Size (measured diagonally)	Approx. 81 cm (32 inch)
Power Consumption	41W
Average Annual Energy Consumption	60kWh
Standby Power Consumption	0.5W
Operating Temperature	0°C – 40°C
Vesa Wall mounting size / Screw size	200x100 mm/M6x10
Speaker Power	8W+8W
Dimension (W x D x H)without base	744x88x462mm
Dimension (W x D x H) with base	744x212x498mm
Weight (Net)	9.6kg
Inputs / Output	
SCART	1
HDMI	3
PC	1
PC AUDIO	1
YPbPr	1
Common Interface (AUDIO IN)	1
AV	1
USB	1
DIGITAL (Coaxial)	1
RF (75 Ω)	1
Earphone (3.5mm)	1
Audio Out	1 (L + R)

Features and specifications are subject to change without prior notice.

Safety Warnings

- Read all the instructions carefully before using the unit and keep them for future reference.
- Retain the manual. If you pass the unit onto a third party make sure to include this manual.
- Check that the voltage marked on the rating label matches your mains voltage.

Damage

- Please inspect the unit for damage after unpacking.
- Do not continue to operate the unit if you are in any doubt about it working normally, or if it is damaged in any way - switch off, withdraw the mains plug and consult your dealer.

Location of Unit

- The unit must be placed on a flat stable surface and should not be subjected to vibrations.
- Do not place the unit on sloped or unstable surfaces as the unit may fall off or tip over.
- The mains socket must be located near the unit and should be easily accessible.
- This unit is designed for indoor use only.

Temperature

- Avoid extreme degrees of temperature, either hot or cold. Place the unit well away from heat sources such as radiators or gas / electric fires.
- Avoid exposure to direct sunlight and other sources of heat.

Naked Flames

- Never place any type of candle or naked flame on the top of or near the unit.

Moisture

- To reduce the risk of fire, electric shock or product damage, do not expose this unit to rain, moisture, dripping or splashing. No objects filled with liquids, such as vases, should be placed on the unit.
- If you spill any liquid into the unit, it can cause serious damage. Switch it off at the mains immediately. Withdraw the mains plug and consult your dealer.

Ventilation

- To prevent the risk of electric shock or fire hazard due to overheating, ensure that curtains and other materials do not obstruct the ventilation vents.
- Do not install or place this unit in a bookcase, built-in cabinet or in another confined space. Ensure the unit is well ventilated.
- Make sure that there is a gap of at least 10 cm on both sides and a gap of 20 cm at the top.

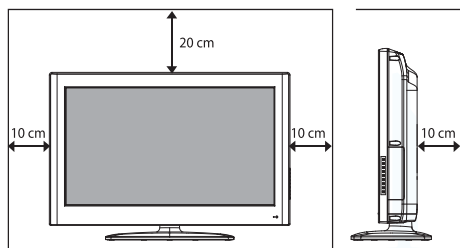

Safety

- Always disconnect the unit from the mains supply before connecting / disconnecting other devices or moving the unit.
- Unplug the unit from the mains socket during a lightning storm.

Mains Cable

- Make sure the unit or unit stand is not resting on top of the mains cable, as the weight of the unit may damage the mains cable and create a safety hazard.
- If the mains cable is damaged it must be replaced by the manufacturer, its service agent, or similarly qualified persons in order to avoid a hazard.

Interference

- Do not place the unit on or near appliances which may cause electromagnetic interference. If you do, it may adversely affect the operating performance of the unit, and cause a distorted picture or sound.

Optimum viewing

- View the unit in moderate light to prevent eye strain. It is recommended to watch the unit from a distance 3-7 times that of the screen height.

LCD screen

- The LCD screen is manufactured using high-precision technology. However, some tiny black points and / or bright points (red, blue or green in colour) may constantly appear on the LCD screen. These points are generated in the manufacturing process and are normal.

Screen Burn

- A characteristic of Plasma and LCD TV Panels is that displaying the same image for a long time may cause a permanent after-image to remain on the screen. This is called screen burn. Most pictures shown on the unit will be constantly moving and fill the screen.
- Examples of images that you need to watch out for are as follows (this is not an all-inclusive list):
 1. **Black Bars:** If black bars appear at the left / right or top / bottom of the screen, it is recommended to change the format so that the picture fills the entire screen.
 2. **TV Channel Logos:** e.g. Shopping channel logos and pricing displays - especially if they are bright and stationary. Moving or low-contrast graphics are less likely to cause ageing of the screen.
 3. **Time Displays**
 4. **Teletext:** Do not view a stationary page for long periods of time.
 5. **TV Menus**
 6. **Pause Mode:** Do not leave the screen in pause mode for long periods of time, e.g. when watching videos.
- To prevent screen burn if viewing any of the above for long periods of time, reduce contrast and brightness when viewing. Once burn-in occurs it will never disappear completely.

Headphones

- Listening to loud sounds for prolonged periods of time may permanently damage your hearing.
- Before putting on headphones, turn the volume down then put the headphones on and slowly increase the volume until you reach a comfortable listening level.

Standby

- The  button on the remote control does not switch off the unit completely. The unit will continue to draw electricity from the mains supply while in standby. In the interests of safety and to avoid unnecessary energy consumption, never leave the unit in standby while unattended for long periods of time, e.g. overnight, while on holiday or while out of the house. Switch it off and disconnect the mains plug from the mains socket.

Batteries

- Batteries used in the remote control for this unit are easily swallowed by young children and this is dangerous.
- Keep loose batteries away from young children and make sure that the battery holder tray is secure in the remote control. Seek medical advice if you believe a cell has been swallowed.
- Please dispose of batteries correctly by following the guidance in this manual.

Supervision

- Children should be supervised to ensure that they do not play with the unit and the remote control.
- Never let anyone especially children push anything into the holes, slots or any other openings in the case - this could result in a fatal electric shock.



The lightning flash with arrowhead symbol, within an equilateral triangle, is intended to alert the user to the presence of uninsulated "dangerous voltage" within the unit's enclosure that may be of sufficient magnitude to constitute a risk of electric shock.



The exclamation point within an equilateral triangle is intended to alert the user to the presence of important operating and maintenance (servicing) instructions in the manual accompanying the unit.

Service

- To reduce the risk of electric shock, do not remove screws. The unit does not contain any user-serviceable parts. Please leave all maintenance work to qualified personnel.
- Do not open any fixed covers as this may expose dangerous voltages.

Maintenance

- Ensure to unplug the unit from the mains socket before cleaning.
- Do not use any type of abrasive pad or abrasive cleaning solutions as these may damage the unit's surface.
- Do not use liquids to clean the unit.

Others

- The apparatus shall not be exposed to dripping or splashing and that no objects filled with liquids, such as vases, shall be placed on the apparatus.
- A warning that an apparatus with CLASS 1 construction shall be connected to A MAINS socket outlet with a protective earthing connection.
- Instructions to ensure correct and safe installation and interconnection of the apparatus in multimedia systems.
- Where the MAINS plug or appliance coupler is used as the disconnect device, the disconnect device shall remain readily operable.
- "To prevent possible hearing damage, do not listen at high volume levels for long periods."



Important Note

This TV is fitted with the latest ECO friendly power saving technology. If whilst viewing the TV remote control is not used for a period of 4 hours, the Auto Standby feature will operate and power down the TV. A warning message will be displayed to inform you that the TV is about to power down.



Packaging materials are not toys. Please keep away from children. Plastic bags can cause suffocation when pulled over the head.

SRS 
TruSurround HD

SRS TruSurround HD™ creates an immersive, feature-rich surround sound experience from two speakers, complete with rich bass, high frequency detail and clear dialogue.

TruSurround HD, SRS and the  symbol are trademarks of SRS Labs, Inc.

All trademarks are the property of their respective owners and all rights are acknowledged

Waste Electrical Recycling

Correct disposal of Product



This sign indicates that this product may not be disposed of with your regular household waste. The recycling and separate collection of such products is your responsibility. Please drop off the above mentioned waste at a designated place for recycling waste electrical and electronic equipment. If you do not know where to drop off your waste equipment for recycling, please contact your local city office or household waste collection service.



The crossed out wheeled dust bin symbol indicates that batteries and /or accumulators must be collected and disposed of separately from household waste.

If the battery or accumulator contains more than the specified values of lead (Pb), mercury (Hg), and/or cadmium (Cd) defined in the Battery Directive (2006/66/EC), then the chemicals symbols for lead(Pb), mercury (Hg) and/or cadmium (Cd) will appear below the crossed out wheeled dust bin symbol.



By participating in separate collection of batteries, you will help to assure the proper disposal of products and batteries thus help to prevent potential negative consequences for the environment and human health.

For more detailed information about the collection and recycling programmes available in your country, please contact your local city office or the shop where you purchased this product.



This appliance complies with European Safety and Electrical directives.

It fulfills the following EU regulations:

EN 55022:2006+A1:2007
EN 55013:2001+A1:2003+A2:2006
EN 61000-3-2:2006+A1:2009+A2:2009
EN 61000-3-3:2008
EN 55024:1998+A1:2001+A2:2003
EN 55020:2007