

28" HD Ready Digital LED TV

Installation & Operating Instructions - Please keep for future reference

151/3644

BUSH
Real Life Technology

LE-28GX01

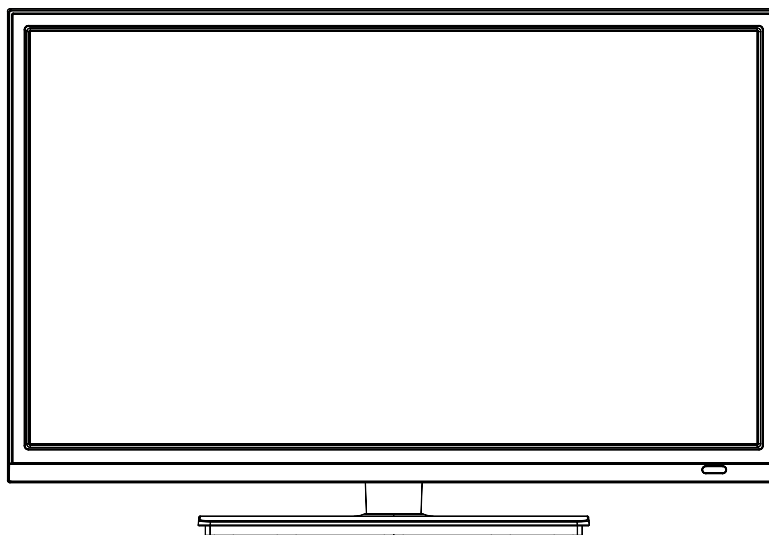

Important - Please read these instructions fully before installing or operating

These instructions contain important information which will help you get the best from your television and ensure safe and correct installation and operation.

**For any help concerning set up and use of your TV please call the
Customer Helpline: 0845 604 0105**

Lines open: 9am - 8pm Monday to Saturday and 10am - 4pm Sunday

Issue 1 - 10/05/13



Contents

Safety Information 2 - 3

Getting Started 4 - 13

Support	4
TV Features	5
Accessories included	5
Base Stand Assembly Instruction	6
Viewing remote control - TV	7-9
TV - Control buttons (Right side)	10
Aerial connection	10
Power connection	10
Remote control - Inserting batteries	11
Switching the TV On and Off	11
Operation using TV control buttons	12
Operation using remote control	12
Initial setup	13
General operation	13

Connections 14 - 16

Left side connections explained	14
Left bottom connections explained	15
HDMI Connections	16
SCART Connections	16
VGA Connections	16

Basic Features 17 - 32

How to navigate menus	17
Electronic programme guide (EPG) (DTV mode)	17
Teletext (ATV mode)	18
Digital Teletext (DTV mode)	19
Time Shift Function (DTV mode)	19-20
Recording DTV Programme onto a USB Storage Device	20
Timer Programming	21
Play Recorded Programme	22
Picture management	22-23
Sound management	23-24

Channel management (ATV / DTV Mode)	24-27
-------------------------------------	-------

Lock System management	28
Setup management	28-32

Entertainment 33 - 35

Viewing Photo	33-34
Listening to Music	34
Viewing Movies	34-35
My Text	35

Other information 36 - 39

Specifications	36
Digital reception	36
Plug replacement - UK and Ireland only	37
Energy label	37
Trouble shooting	38
Supported file formats	39
Disposal information	39

Safety Information

Important - Please read these instructions fully before installing or operating



CAUTION
RISK OF ELECTRIC SHOCK
DO NOT OPEN



CAUTION: TO REDUCE THE RISK OF ELECTRIC SHOCK, DO NOT REMOVE COVER (OR BACK). NO USER-SERVICEABLE PARTS INSIDE. REFER SERVICING TO QUALIFIED SERVICE PERSONNEL.



The lightning flash with arrowhead symbol, within an equilateral triangle, is intended to alert the user to the presence of uninsulated "dangerous voltage" within the product's enclosure that may be of sufficient magnitude to constitute a risk of electric shock of persons.



The exclamation point within an equilateral triangle is intended to alert the user to the presence of important operating and maintenance (servicing) instructions in the literature accompanying the appliance.

Power source

- The TV should be operated only from a 100-240V AC, 50 Hz outlet.
- **Warning:** Do not leave your TV in standby or operating mode when you leave your house.

Positioning the TV

- For ventilation, please leave a clear space of at least 10cm all around the TV.

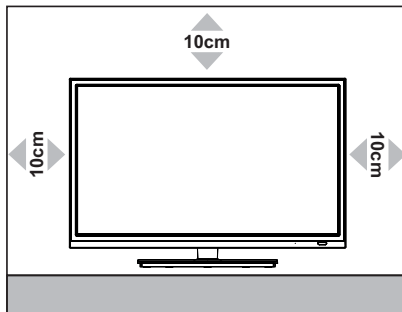

- **Do not** block the ventilation openings.
- Do not place the TV on sloping or unstable surfaces, the TV may tip over.
- To prevent damage to the TV, do not place any objects on top of the TV.
- Only use the TV in moderate climates.

Power cord and plug

- The power cord plug should be easily accessible. In case of storms and lightning, when going on holiday, or when the TV is not used for a long period of time disconnect the power cord from the mains power socket.

- **Do not** place the TV, furniture, etc. on the power cord or pinch the cord.
- Handle the power cord by the plug, do not unplug the TV by pulling the power cord.
- Never touch the power cord/plug with wet hands as this could cause a short circuit or electric shock.
- Never make a knot in the power cord or tie it with other cords.
- Power cords should be placed in such away that they are not likely to be stepped on or driven over.
- A damaged power cord/plug can cause fire or give you an electric shock. When damaged it must be replaced, this should only be done by qualified personnel.

Moisture and Water

- **Do not** use this TV in a humid or damp place (avoid bathrooms, the sink in the kitchen, and near the washing machine).
- **Do not** expose this TV to rain or water, as this may be dangerous.
- **Do not** place objects filled with liquids, such as flower vases, on top of the TV. Avoid from dripping or splashing.
- If any solid object or liquid falls into the cabinet, unplug the TV and have it checked by qualified personnel before operating it any further.

Ventilation

- The slots and openings on the TV set are intended for ventilation and to ensure reliable operation.
- To prevent overheating, these openings must not be blocked or covered in anyway.



Safety Information

Important - Please read these instructions fully before installing or operating

Heat sources and Flames

- **Do not** expose the TV to direct sunlight or other heat sources.
- The TV should not be placed near to open flames and sources of intense heat such as an electric heater.
- Ensure that no open flame sources, such as lighted candles, are placed on top of the TV.

Headphone volume

- Excessive sound pressure from earphones and headphones can cause hearing loss, please take care.

Wall mounting (optional)

To prevent injury, this TV must be securely attached to the wall in accordance with the installation instructions (if the option is available).

LCD Screen

- The LCD screen is a very high technology product with about a million thin film transistors, giving you fine picture details. Occasionally, a few non-active pixels may appear on the screen as a fixed blue, green or red point. Please note that this does not affect the performance of your product.
- Take care not to scratch the screen with fingernails or other hard objects.

Cleaning

- Before cleaning, unplug the TV from the wall socket.
- **Do not** use liquid or aerosol cleaners. Only use a soft, dry cloth.

Batteries

- **Warning:** Incorrect installation of batteries may cause battery leakage and corrosion, resulting in damage to the remote control.
- **Do not** mix old and new batteries, or batteries of different types.
- **Do not** dispose of batteries in a fire.
- **Do not** dispose of batteries with normal household waste, take to a local recycling centre.



Replacement parts

When replacement parts are required, make sure that the service technician has used replacement parts, which are specified by the manufacturer or have the same specifications as the original one. Unauthorised substitutions may result in fire, electrical shock or other hazards.

Servicing

- **Warning:** Risk of exposure to radiation from class 1/ class 3b visible and invisible laser beams. **Do not** open the TV and stare directly into beam.
- **Warning:** Risk of electric shock, do not attempt to repair, service or modify this TV yourself. Contact the manufacturer, their approved service agent or the **Customer Helpline: 0845 604 0105**.

This equipment is a Class II or double insulated electrical appliance. It has been designed in such a way that it does not require a safety connection to electrical earth.

- **Warning: To prevent the spread of fire, keep candles or other open flames away from this product at all times.**

Getting Started

The Argos Technical Helpline is here to help

Technical experts are available 7 days a week

- **Simple help and advice on setting up your digital equipment (image).**
- **Guidance on connecting other devices to your television such as a DVD player, Sky, home cinema system or a games console.**
- **Order spare parts, including that lost remote control.**
- **Any other technical issues you may need assistance with.**

Call us today: 0845 604 0105

Local call rates applies*

Lines open 9am-8pm Monday to Saturday and 10am-4pm Sunday.

*Calls to Argos enquiry lines may attract a charge and set up fee from residential lines depending on your call plan/tariff. Mobile and other providers costs may vary, see www.bt.com/pricing for details.

For Security and training purposes, telephone calls to and from customer service centres maybe recorded and monitored. Calls from Republic of Ireland will attract international call charges.

Getting Started

TV - Features

- Remote controlled colour LCD TV.
- Fully integrated digital TV (DVB-T).
- HDMI connectors for digital video and audio. This connection is also designed to accept high definition signals.
- USB input.
- 100 programmes from VHF, UHF (analogue).
- 400 programmes for digital mode (DTV).
- OSD menu system.
- Scart socket for external devices (such as video, video games, audio set, etc.).
- Stereo sound system.
- Teletext, fasttext, TOP text.
- Headphone connection.
- Automatic programming system.
- Forward or backward manual tuning.
- Sleep timer.
- Child lock.
- AVL (Automatic Volume Limiting).
- PLL (Frequency Search).
- PC input.
- Plug & Play for Windows 98, ME, 2000, XP, Vista.

Accessories included

• TV

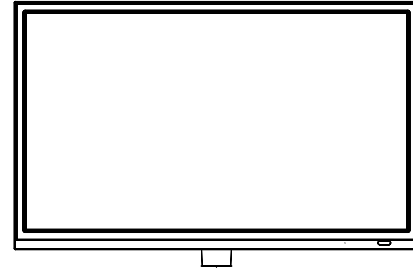

• Stand Base



• Screw (4PCS)



• MINI YPBPR Cable



• Remote Control

• Batteries: 2 x AAA

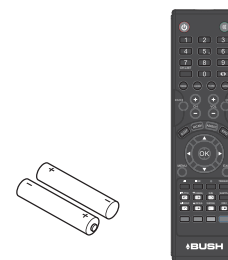

• Instruction Book



Getting Started

Installing / Removing the Base Stand

Base Stand Assembly Instruction

1. Place the TV with the display side down on a flat surface. Use a cloth to protect. Locate the bottom at the stand.
2. Fix the bottom with turning the screw (4PCS) tightly on the stand.

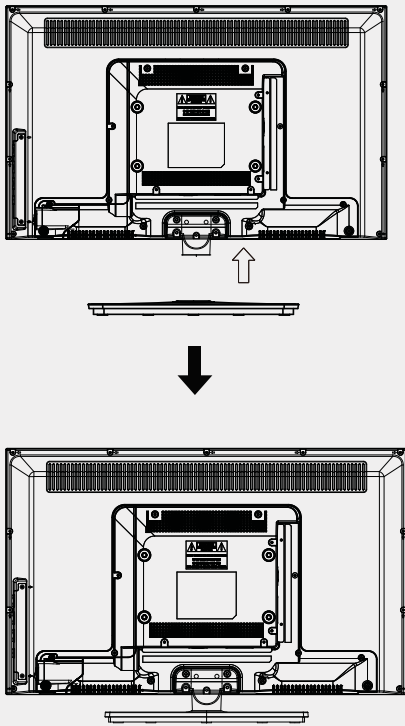

INSTALLATION NOTES

This TV can be connected to an AC 100-240 Volts, 50/60 Hz power supply. Never connect straight to a DC power supply.

Locate the TV in a room where light does not strike the screen directly. Total darkness or a reflection on the screen can cause eyestrain. Soft and indirect lighting is recommended for comfortable viewing.

Allow enough space between the TV and the wall to permit ventilation.

Avoid excessively warm locations to prevent possible damage to the cabinet or premature component failure.

WALL MOUNTING INSTALLATION GUIDELINES

This television can be wall mounted as follows:

1. Place the LED LCD Television onto a solid surface. Please place some soft material over the front of the screen to protect it from any damage.
2. Remove the screws (4PCS) from the lower part of the television, where the base joins to the TV, and take away the stand (put the stand somewhere safe for future use).

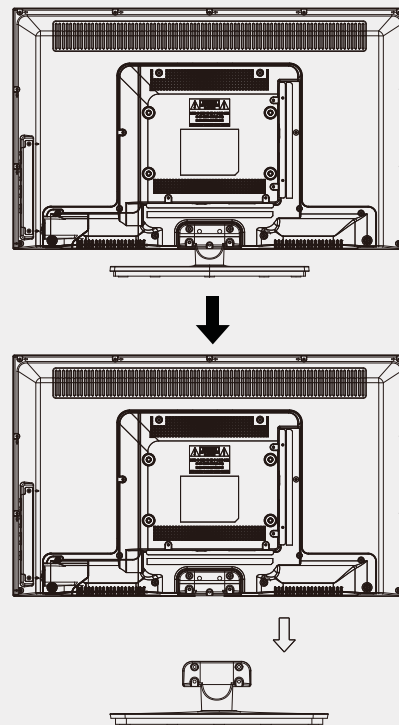

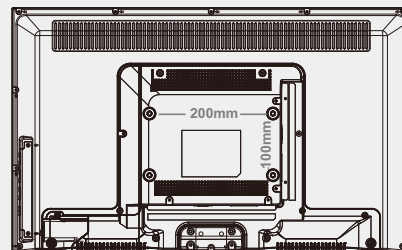

3. Use the four screws provided to fix the TV onto a wall mounting bracket (not included) via the four VESA standard holes on the back of the television.



200 x 100mm VESA mount

Getting Started

Viewing remote control - TV

- 1. **
Switches the TV between on and standby mode.
- 2.  MUTE**
Mutes and restores your TV sound.
- 3. 0-9 Number Button**
Press to select a programme. (ATV / DTV mode)
- 4. CH.LIST**
Display channel list. (ATV / DTV mode)
- 5. **
Return to the previous viewing channel. (ATV / DTV mode)
- 6. P.MODE**
Select picture mode: Dynamic / Standard / Mild / Personal.
- 7. S.MODE**
Select sound mode: Standard / Music / Movie / Personal.
- 8. TV.RD**
Select TV program or Radio program. (DTV mode).
- 9. LANG**
Select DTV audio language. (DTV mode)
- 10. SOURCE**
Select among the different input signal sources: DTV / ATV / AV / SCART / YPbPr / HDMI1 / HDMI2 / HDMI3 / PC / USB.
- 11. DISPLAY**
Display the present screen information such as the current channel and the input source.
- 12. CH+/-**
Select a channel.
- 13. VOL+/-**
Adjust the volume.
- 14. NICAM**
Switch between different audio channels (only applicable when the TV programme has this feature).
- 15. ASPECT**
Select from the following mode settings: 16:9 / Zoom1 / Zoom2 / Auto / 4:3.

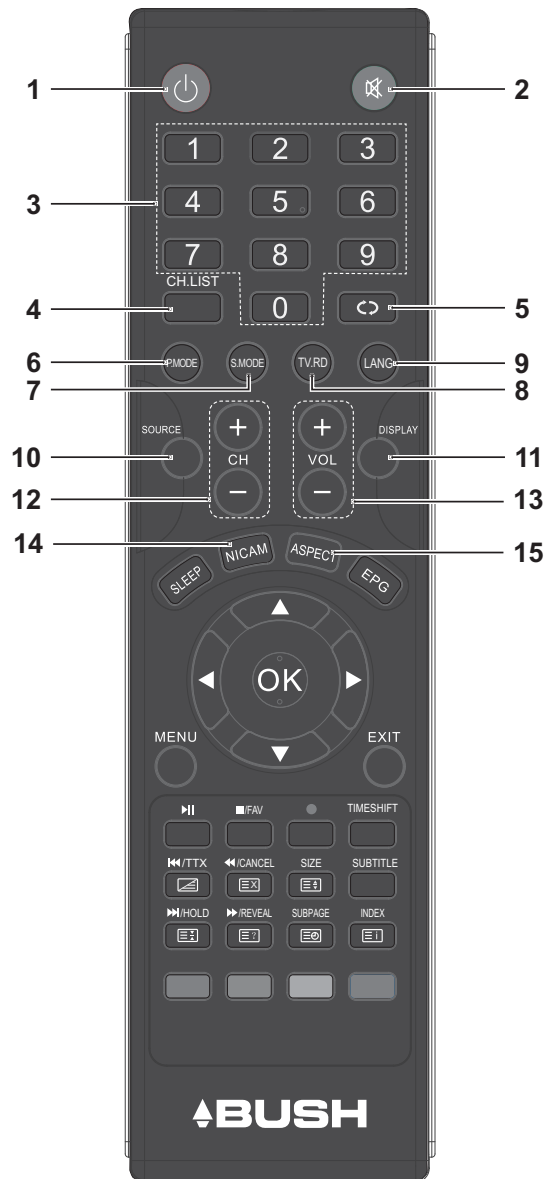

Getting Started

Viewing remote control - TV

16. SLEEP

Set the TV sleep timer.

17. EPG

Display the EPG (Electronic Program Guide). (DTV mode)

18. ◀▶▲▼

Allows you to navigate the OSD menus and adjust the system settings to your preference.

OK

- Confirm the selection in the OSD menus.
- Display a list of channels saved in the TV tuner memory.

19. MENU

Display the OSD (On Screen Display) menu.

20. EXIT

Exit the OSD (On Screen Display) menu.

21. ■

Press once to stop. (USB mode)

FAV

Display the Favourite Channel list. (ATV / DTV mode)

22. ●

Record the current programme. (DTV mode)

23. ▶||

- To start the timeshift playback. (DTV mode)
- To start playback or pause. (USB mode)

24. TIMESHIFT

Start the time-shift function. (DTV mode)

25. ☒ TTX

Turn on and off the Teletext function. (ATV / DTV mode)

◀◀

To skip to the beginning of the previous chapter / track / photo. (USB mode)

26. SUBTITLE

Display the subtitle which is broadcast with the program. (DTV mode)

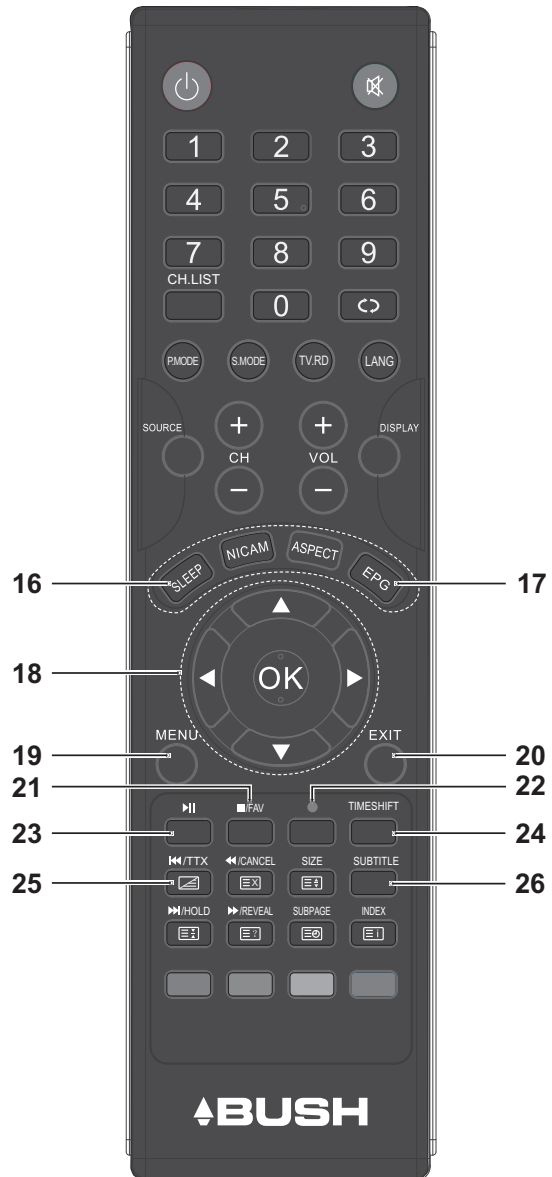

Getting Started

Viewing remote control - TV

27. CANCEL

To exit the teletext mode. (ATV / DTV mode)



To reverse playback rapidly. (USB mode)

28. SIZE

To enlarge the picture on the TV in teletext. (ATV / DTV mode)

29. HOLD

Freezes a multi-page passage on screen in teletext. (ATV / DTV mode)



To skip to the beginning of the next chapter / track / photo. (USB mode)

30. INDEX

To select the page number of the index from teletext. (ATV / DTV mode)

31. REVEAL

Reveals hidden information such as the answer to a quiz in teletext. (ATV / DTV mode).



To advance playback rapidly. (USB mode)

32. SUBPAGE

Displays the subpage on the teletext screen. (ATV / DTV mode)

33. RED/GREEN/YELLOW/BLUE

Press these buttons directly to select corresponding function on the screen.



Getting Started

TV - Control buttons (Rear side)

1. VOL+button

Increases the volume.

2. VOL- button

Decreases the volume.

3. CH+button

Moves up a channel.

4. CH- button

Moves down a channel.

5. MENU button

Displays the OSD (on screen display) menu.

6. SOURCE button

Press to select among different input signal sources: DTV / ATV / AV / SCART / YPbPr / HDMI1 / HDMI2 / HDMI3 / PC / USB. Confirmed the selection on OSD menu.

7. (⏻) button

Turns the TV on when in standby mode or turns the TV off into standby mode.

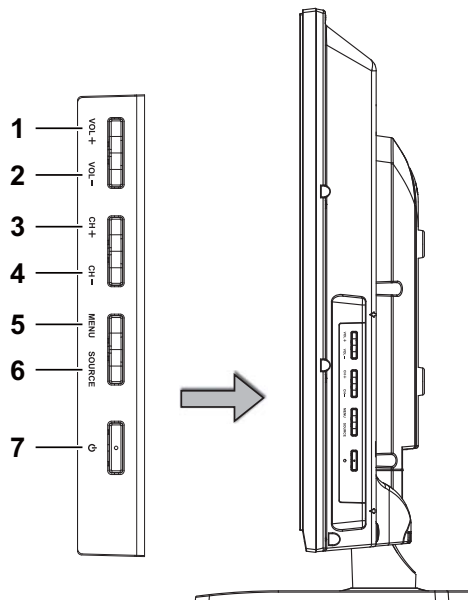

Aerial connection

Connect the "aerial" or "cable TV" plug to AERIAL INPUT (ANT.) socket located on the back of the TV.

Power connection

Please note: After unpacking, allow the TV to reach ambient room temperature before connecting the TV to the mains power socket.

Connect the power cord plug to the mains power socket.

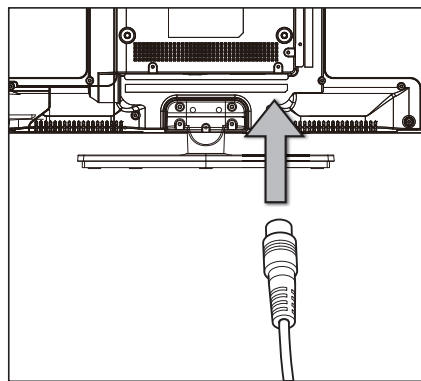

Getting Started

Remote control - Inserting batteries

Remove the battery cover on the back of the remote control, gently push down and pull backwards at the same time as shown.

Insert two AAA/R3 or equivalent type batteries. Ensure the batteries are inserted the correct way and replace the battery cover.

Note: When the remote control is not going to be used for long periods of time, the batteries should be removed. Otherwise the remote control may be damaged, caused by battery leakage and corrosion.

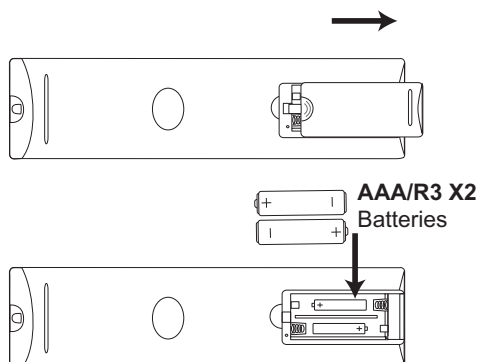

Switching the TV On and Off

Switching the TV On

With power cord plug connected to the mains power socket and TV in 'Standby' mode.

To switch the TV on from standby mode, either:

a: The Remote control; Press the “⏻” button.

b: The TV; Press the “⏻” button at the right of the TV.

Switching the TV Off

Either press the “⏻” button on the remote control or press the “⏻” button at the right of the TV, the TV will then switch to standby mode.

Getting Started

Operation using TV control buttons

The **VOL+/VOL-** buttons will function as volume up/down as default. Even if you set other functions for these buttons, the **VOL+/VOL-** buttons will return to volume control after a short while.

Volume Setting

Press **VOL+/VOL-** buttons to increase or decrease volume.

Programme Selection

Press **CH+/CH-** buttons to select the next or previous programme.

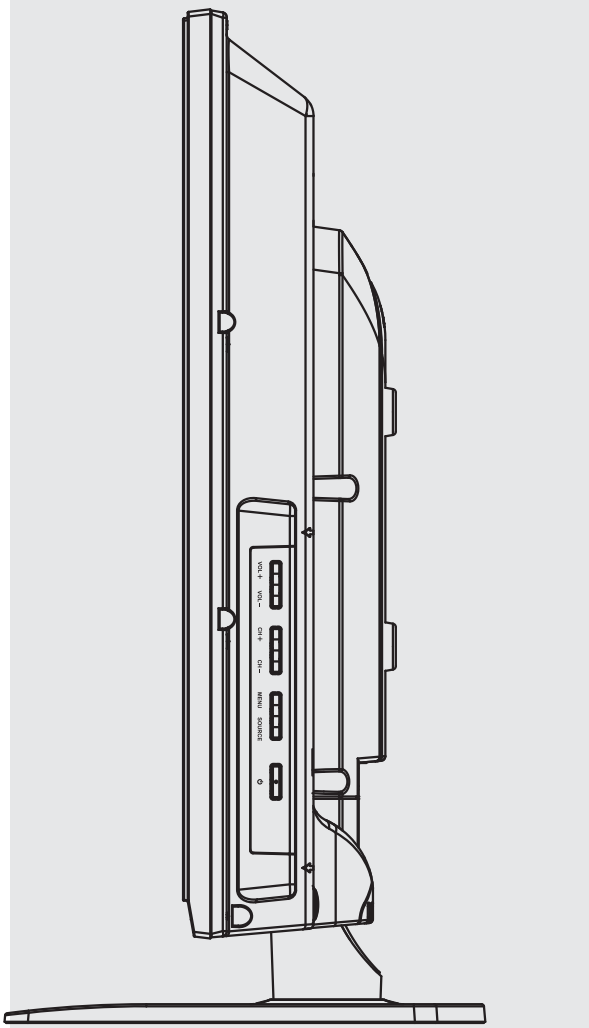

Operation using remote control

The remote control is designed to control all the functions of the model you selected.

Volume Setting

Press **VOL+** button to increase the volume. Press **VOL-** button to decrease the volume. A volume level scale (slider) will be displayed on the screen.

Programme Selection (Previous or Next Programme)

Press **CH-** button to select the previous programme.
Press **CH+** button to select the next programme.





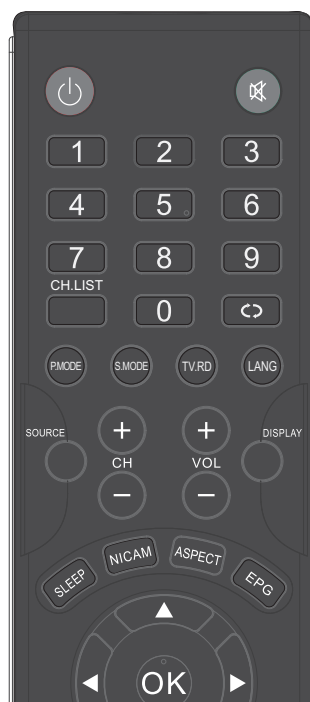

Programme Selection (Direct Access)

Press number buttons on the remote control to select programmes between 0 and 9. The TV will switch to the selected programme.



Getting Started

Initial setup

1. Connect one end of the RF coaxial cable to the aerial socket on the wall and the other end of the cable to the RF (75Ω) socket at the right side of your TV.
2. Connect the mains cable to the mains socket after you have completed all the connections.
3. With power cord plug connected to the mains power socket and TV in 'Standby' mode. At this stage, the TV switches to standby mode. The red LED indicator will illuminate on the front panel of the TV.
4. In standby mode, press the  button at the right of the TV or the  button on the remote control to turn the TV on. The red LED indicator will turn blue.
5. The first time you turn the TV on, it will go straight into **First Time Setup** menu. Press the     buttons to navigate the menu and change the settings.

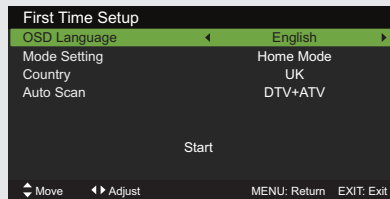

OSD Language

Selects your desired language to be displayed on the menu. The default on-screen menu language is set as English.

Mode Setting

Selects your desired mode setting.

- Home Mode: Viewing at home.
- Store Mode: For store demo, the brightness is higher than home mode.

Country

Selects the country where you will operate the TV. The default country is set as UK.

Auto Scan

Selects the auto scan type: DTV+ATV / DTV / ATV.

Start

Press the **OK** button to start auto tuning. Auto Scan will commence. The display will show the progress of the tuning and the number of channels found.

Initial setup

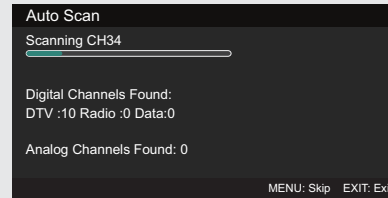

6. If you want to skip the DTV tuning, press the **MENU** button to interrupt the tuning half way. You will then go straight to ATV tuning. You may repeat the above step if you also want to skip the ATV tuning.

General operation

Press the **SOURCE** button on the remote control and select DTV to switch the TV to Digital Terrestrial Television Broadcasting.

Information Banner

Whenever you change channel using the **CH+ / CH-** buttons or the number buttons, the TV displays the broadcast picture along with an information banner on the top left of the screen (available only in DTV/ATV mode).

The information banner can be displayed at any time while watching TV by pressing the **DISPLAY** button on the remote control.

Connections

Left side connections explained

1. YPbPr

YPbPr Input socket is just suitable for YPbPr Input Mini Cable.

Connect to a DVD player, Digital Set-Top-Box, or other AV devices with component (YPbPr) video output sockets.

2. Headphone jack

To connect an external headphone to the TV. Connect to the HEADPHONE jack to listen to the TV from headphones.

Note: Headphone volume can be changed using "VOL+" or "VOL-" buttons.

3. HDMI Input

Connects a device that has an HDMI socket. The TV can display High Definition pictures from devices such as a High Definition Satellite Receiver or DVD Player. These devices must be connected via the HDMI sockets or Component Socket. No sound connection is needed for an HDMI to HDMI connection.

4. CI Slot

Used to insert a CI card. A CI card allows you to view all the channels that you subscribe to. For more information, see "Conditional Access" section.

5. USB Input

To connect devices to the TV, providing fast data exchange. USB will have function in USB/DTV mode.

6. COAXIAL

To connect to the audio socket on the digital/standard 5.1 audio system.

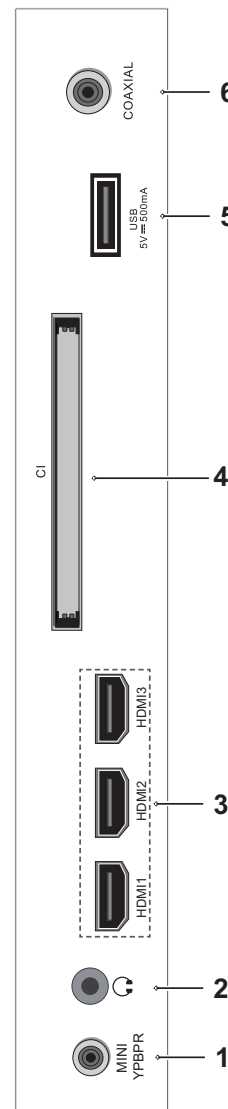
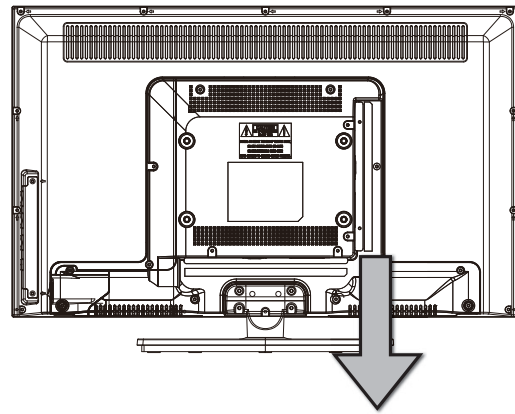

Connections

Left bottom connections explained

7. Video Input

To connect video signals of external devices. Connect the video cable between the VIDEO IN socket on the TV and the VIDEO OUT jack on your device.

8. SCART socket

Inputs or outputs for external devices. Connect the SCART cable between the SCART socket on the TV and the SCART socket on the external device (decoder, VCR or DVD player).

Note: If an external device is connected via the SCART socket, the TV will automatically switch to SCART mode.

9. PC Input (VGA) / PC AUDIO

Connects a personal computer to the TV. Connect the PC cable between the PC INPUT on the TV and the PC output on the PC.

Note: If you connect a device to the TV via the PC cable, you should also use an audio cable to connect your device to the PC AUDIO INPUT to enable audio.

10. RF Input (ANT.)

Connects to aerial (antenna) or cable TV. If you use a decoder or a media recorder, you should connect the aerial cable through the device to the TV with an appropriate aerial cable.

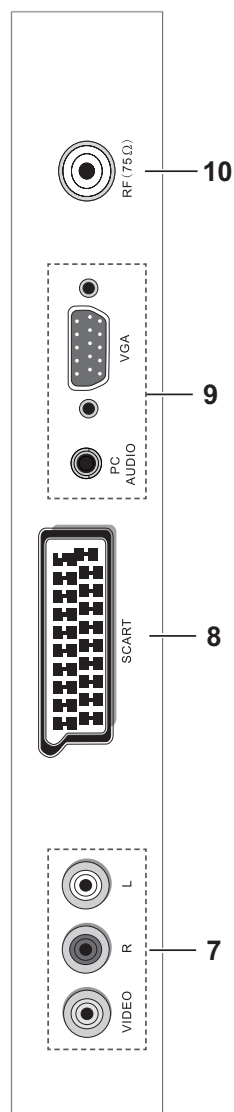
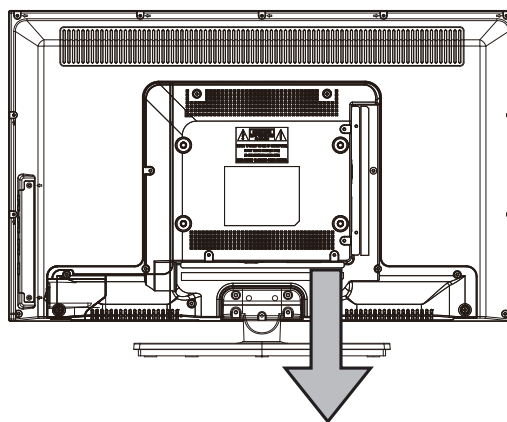

HDMI Connections

HDMI lets you enjoy high definition digital images and high quality sound by connecting the TV to external devices such as DVD players, set top boxes or gaming equipment.

Power off both the TV and the device before making any connections.

For more information, refer to your device's own instruction book.

When connecting, switch "Source" to "HDMI". See, "Input Selection" section.

Note: HDMI cable is not supplied.

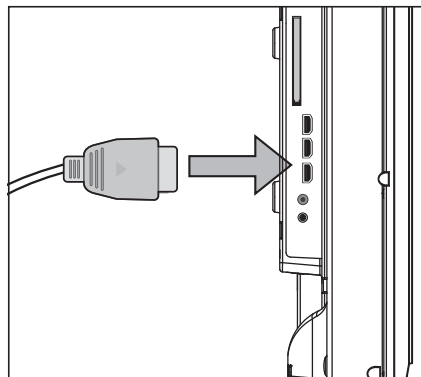

SCART Connections

Most devices support SCART connection. You can connect a DVD recorder, VCR or decoder to the TV using the SCART socket.

Power off both the TV and the device before making any connections.

For more information, refer to your device's own instruction book.

Note: The Scart cable is not supplied.

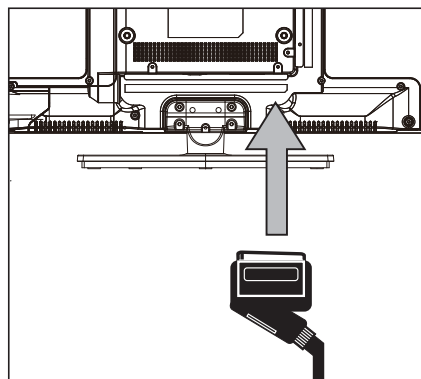

VGA Connections

You can connect a computer (PC) to the TV to display your computer's screen image on the TV.

Power off both computer and TV **before** making any connections.

Use a 15-pin D-sub display cable to connect a PC to the TV. Use an audio cable between PC AUDIO inputs on the left side of the TV and audio output on your PC to enable sound connection.

When the connection is made, switch "Source" to "PC". See "Input selection" section.

Set the resolution that suits your viewing requirements. Resolution information can be found in the "Appendix parts".

Note: The VGA cable is not supplied.

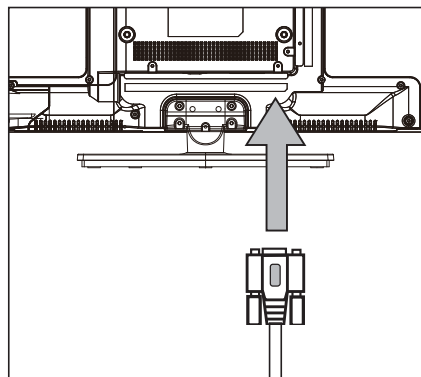

Basic Features

How to navigate menus - Selecting source

1. Press the **SOURCE** button at the right of the TV or the **SOURCE** button on the remote control to display the Input source list.
2. Press the **▲▼** buttons to select the input source that you want: DTV / ATV / AV / SCART / YPbPr / HDMI1 / HDMI2 / HDMI3 / PC / USB.
3. Press **OK** button to confirm your selection.

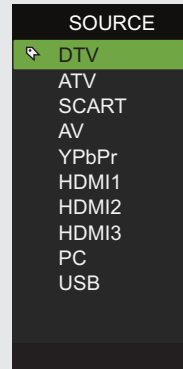

Electronic programme guide (EPG) (DTV mode)

This system has an Electronic Programme Guide (EPG) to help you navigate through all the possible viewing options.

The EPG supplies information such as programme listings, start and end times for all available services. In addition, detailed information about the programme is often available in the EPG (the availability and amount of programme information will vary, depending on the particular broadcaster).

This function can be used only when the EPG information is broadcast by broadcasting companies.

The EPG displays the programme details for the next 7 days.

1. Press the **EPG** button to switch on EPG.



2. Press **EPG** button or **EXIT** button again to switch off EPG and return to normal TV viewing.

Info bar commands:

RED (Prev. Date)

Press the **RED** button to view the schedule of the previous day.

GREEN (Next Date)

Press the **GREEN** button to view the schedule of the next day.

YELLOW (Schedule)

Press the **YELLOW** button to view the preset reminders in the schedule list. Press the **YELLOW** button to return to the EPG.

BLUE (Reminder)

Press the **BLUE** button while on the selected programme, the Reminder setting menu will be displayed.

Press the **▲▼◀▶** buttons to adjust the settings and then press the Save button to confirm the settings. After confirmation, the EPG Schedule List will then be displayed with your preset reminders shown. Press the **YELLOW** button to return to the EPG. The TV will automatically tune to the selected programme when it starts.

REC

Timer Programming.

OK

Press to display detailed information of the selected programme (if available).

Basic Features

Teletext (ATV mode)

Teletext is a free service broadcast by some TV stations which gives up-to-the-minute information on news, weather, television programmes, share prices and many other topics. Using the Teletext control buttons you can view pages of information that are listed in the teletext index.

To Turn on Teletext Function



Make sure the TV channel you are watching transmits teletext.
"No Teletext" sign will show on the screen if teletext is not available.

In ATV mode, press the **TTX** button to enter Teletext mode. Press the **INDEX** button to display the index page.

Press the **TTX** button once to exit and the TV will return to the channel you were watching.

To select a page of text

Find the number of the page in the index and enter it using the **0-9** buttons. The number of the page will appear on the top left corner of the screen.

The page counter will search for your page. When it finds it, the page will be displayed.

To move to the next page of text, press the button.

To move to the previous page, press the button.

To return to the index page, enter the "100" by using the **0-9** buttons or press the **INDEX** button.

Mix

To view a page of text while watching a TV programme, press the **TTX** button twice. The text will be superimposed over the TV programme.

Double height text

If you have difficulty reading the text on the TV you can double the height of the text.

Press the **SIZE** button. The top half of the page will be displayed in double height text.

Press the **SIZE** button again. The bottom half of the page will be displayed in double height text.

Press the **SIZE** button again to return to the full page.

Page HOLD

If the page of text you have selected contains subpages, these subpages will automatically be displayed in order with a delay to allow you to have enough time to read the page.

To stop the movie to the next sub page, press the **HOLD** button.

To continue moving through the sub pages, press the **HOLD** button again.

*Alternative: Press the **SUBPAGE** button, and then use the 0-9 buttons to enter a 4-digit page number.*

To Reveal Information

Press the **REVEAL** button to reveal concealed information (quiz answers etc.).

Press the **REVEAL** button again to conceal the information again.

Fasttext

At the bottom of the teletext screen is a row of subject headings in red, green, yellow and blue.

The remote control has a row of colour buttons corresponding to the row of coloured subjects on the screen.

Pressing one of the colour buttons will take you directly to the page corresponding to the subject heading.

Basic Features

Digital Teletext (DTV mode)

Digital teletext can access special digital teletext services and specific services which broadcast digital teletext. You will need to turn off Subtitle Function before using teletext.

1. In DTV mode, press the  **TTX** button to display the teletext page.



2. Press the **0-9** buttons to select a page number.
3. Follow the instructions on digital teletext and move onto the next step by pressing **OK**, **▲▼**, **◀▶**, **RED**, **GREEN**, **YELLOW**, **BLUE** or **0-9** buttons etc.
4. To change digital teletext service, select a different service by pressing the **0-9** buttons or the **▲▼** buttons.

*Alternative: You may press the **RED** button to the  **TTX** button to display the teletext information when you see a ● red logo displayed on the screen (e.g. BBC).*

5. Press the  **TTX** button to exit.

Time Shift Function (DTV mode)

This function allows the TV to virtually record the live viewing broadcast programme.

Note: If the transfer rate of the USB storage device is too slow for recording or time shift function, a warning statement will be shown on the screen. If this happens, please upgrade your USB storage device.



- Time Shift Mode and Recording functions may not work if the signal strength is weak.
- Stop the time-shift function before switching to another input source.

During normal TV viewing, you may press the **TIMESHIFT** button to virtually pause the live viewing broadcast programme if you want to go out for a while (e.g. going to the bathroom / kitchen). "II" will show on the screen.

When you have returned, press the **▶||** button to display the PVR Time Shift progress bar and then press the **◀▶** buttons to select "▶" on the bar. Press the **OK** button to play the missed broadcast programme. "▶" will show on the screen.

The video and sound may have a little bit of delay or be out-of-sync for a few seconds when the unit starts to playback the missed broadcast

programme. It will soon turn to normal.



The 'PVR Time Shift Progress Bar'

- 1 Indicates the status of the currently displayed video (▶ / II / ◀◀ / ▶▶)
- 2 Indicates the time lagging behind the live broadcast (PVR reviewing)
- 3 Indicates the available recording time on your USB storage device

Basic Features

Time Shift Function (DTV mode)

Using the Remote Control

You can shift playback to any point of the virtually recorded programme. Press the **TIMESHIFT** button to display the PVR Time Shift progress bar again.

TIMESHIFT

During playback, press the **TIMESHIFT** button to display a still screen.

◀◀ or ▶▶

When playing,

- Press the ◀◀ button repeatedly to speed up ◀◀ x 2 / x 4 / x 8 / x 16.
- Press the ▶▶ button repeatedly to speed up ▶▶ x 2 / x 4 / x 8 / x 16.
- During fast forward / fast backward state, press the ▶|| button to return to normal playback.

◀◀ or ▶▶

- Press the ▶|| button to jump about 10% forward.
- Press the ◀◀ button to jump about 10% back.

▶||

- During playback, press the ▶|| button to display a still screen and then press the ▶|| button again to resume playback.

- During fast forward / fast backward state, press the ▶|| button to return to normal playback.

OK / ■

If you want to exit the PVR Time Shift progress bar and return to the current live broadcast, press the **OK / ■** button and then press the ◀ button to confirm.

Recording DTV Programme onto a USB Storage Device

Use this function to record the DTV programme you are watching on the main screen and save it for future viewing. The recording from timer programme or direct recording may have a little bit of delay when it starts to record the broadcast programme.

Please make sure the USB device is inserted. If not, a warning message will pop up.

1. Press the ● **REC** button to record the programme that you are currently watching.



To display the recording information, press the ● **REC** button.

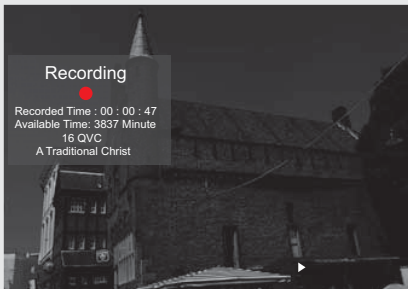

2. Press the ■ **Stop** button to stop recording.



Recording will stop automatically when the disk is full.



- If a hard disk is used, make sure its mains adapter is connected to the mains supply.
- If a USB hub is used, make sure its mains adapter is connected to the mains supply as the total current consumption may exceed 500mA.
- The maximum supported storage space of the hard disk is 1 TB.
- The file system only supports FAT32 format.
- If you want to store the video streaming of a DTV programme, the transfer rate of the USB storage device must not be less than 5MB/s, otherwise the picture and sound of the programme will be affected and a warning statement will be shown on the screen. If this happens, please upgrade your USB storage device.
- The TV screen will be blank temporarily as it will take time to start up and stabilise the connected hard disk. This is normal and the starting time may vary depending on the brand and the memory size of the connected hard disk.
- Disconnect the USB storage device if it is not in use.

Basic Features

Timer Programming

This function is used for scheduled recording.

The recording from timer programme or direct recording may have a little bit of delay when it starts to record the broadcast programme.

Please make sure the USB device is inserted. If not, a warning message will pop up.

1. Press the **EPG** button on the remote control. The **EPG** menu will appear.



2. Press the **● (REC)** button on the remote control while on the selected programme, the **Scheduled Record** menu will be displayed. Press the **▲▼◀▶** buttons to select the settings in the **RECORD** menu for the Frequency, Channel, Start time, and End time.

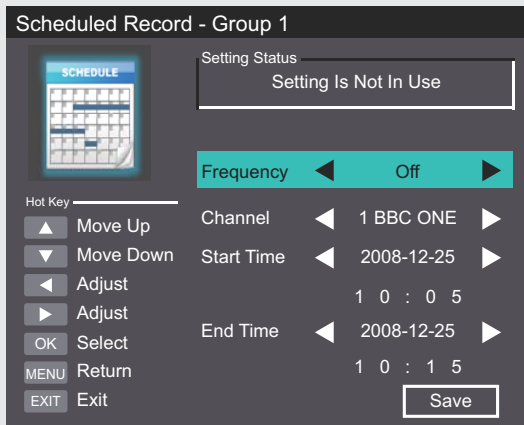

Frequency

Press the **◀▶** buttons to select the frequency (Off/Once / Daily / Weekly / Weekday).

Channel

Press the **OK** button and then press the **▲▼** buttons to select the channel that you want to record.

Start time (for Mode Once, Daily, Weekly, Weekday) Press the **▲▼◀▶** buttons to adjust the start time.

End time (for Mode Once, Daily, Weekly, Weekday) Press the **▲▼◀▶** buttons to adjust the end time.

3. After finishing all the recorder adjustments, press the Save button to confirm your settings.

4. The **Scheduled Record Setting List** will then be displayed with your preset reminders shown.

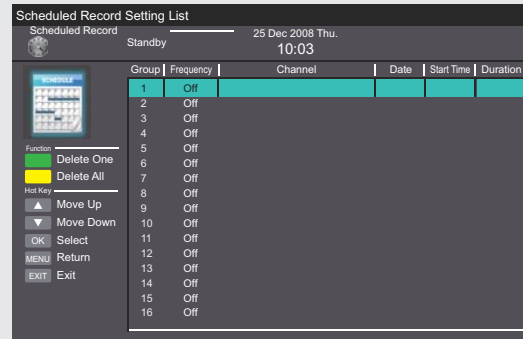

5. Press the **EXIT** button to exit EPG.



- When the preset time is reached, the TV will start recording automatically.
- If a programme recording starts when the TV is in standby mode, the LED indicator will alternatively flash red and blue.

Basic Features

Play Recorded Programme

You can play a recorded programme from the recorded programme list or from a USB Storage Device.

1. Press the **SOURCE** button at the right of the TV or the **SOURCE** button on the remote control then press the **▲▼** buttons to select the **USB** mode and then press the **OK** button.
2. Press the **◀▶** buttons to select **MOVIE** and then press the **OK** button.

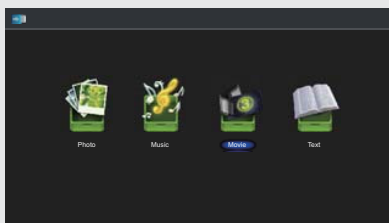

3. Press the **▲▼** buttons to select your storage device and then press the **OK** button.

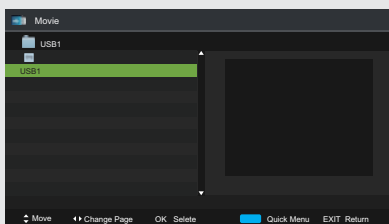

4. Press the **▲▼** buttons to select the "usbrecord" folder and then press the **OK** button.

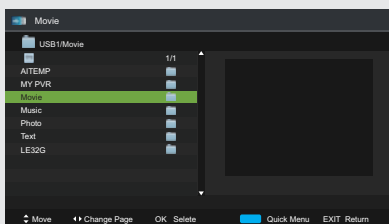

5. Press the **▲▼** buttons to select your recorded programme and then press the **▶||** button to view.

Play Recorded Programme

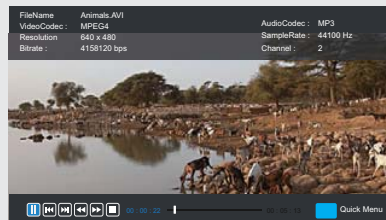

6. Press the **OK** button or the **DISPLAY** button to display the function bar. Press the **◀▶** buttons and then press the **OK** button to select the function: Pause / Prev. / Next / FB / FF / Stop / Quick Menu (Repeat / Encode Type).
7. Press the **EXIT** button to return to the previous menu.

Picture management (ATV / DTV Mode)

1. Press the **MENU** button to display the main menu. Press the **◀▶** buttons to select **Picture** in the main menu, then press the **▼** or **OK** button, it will highlight the first option.
2. Press the **▲▼** buttons to select the option you want to adjust in Picture menu.
3. Press the **◀▶▲▼** buttons to change the following settings.

TIPS:

- You can change the value of brightness, contrast, sharpness and saturation when the picture is in Personal mode.
- You can press **P.MODE** button on the remote control to change the Picture Mode directly.



Basic Features

Picture management

Picture Mode

Allows the selection of a picture-enhancement technical from among the following options: Dynamic / Standard / Mild / Personal.

Brightness

This item can adjust the optical fiber output of the entire picture; it will affect the dark region of the picture.

Contrast

This item can adjust the highlight intensity of the picture, but the shadow of the picture is invariable.

Sharpness

This item can adjust the peaking in the detail of the picture.

Saturation

This item can adjust the saturation of the color based on your own like.

Hue

This item may use in compensating color changed with the transmission in the NTSC code.

Color Temp

This item can increase or reduce warm color of the picture personally (red), and the cold color (blue) according to your like. The choice of Cold, that means it will increase the blue tone for the white. But choosing the Warm, it will increase the red color for the white.

Aspect Ratio

Allows you to watch the screen in various picture formats: Auto / 4:3 / 16:9 / Zoom1 / Zoom2.

Advanced Settings

- Noise Reduction: Reduces the noise level of the connected device (Medium / Strong / Off / Weak).
- Dynamic Contrast: Adjusts the dynamic contrast (Medium / Strong / Off / Weak).

4. Press the **EXIT** button to exit menu.

Sound management

1. Press the **MENU** button to display the main menu. Press the ◀▶ buttons to select **Sound** in the main menu, then press the ▼ or **OK** button, it will highlight the first option.
2. Press the ▲▼ buttons to select the option you want to adjust in Sound menu.
3. Press the ◀▶▲▼ buttons to change the following settings.

TIPS:

- You can change the value of treble and bass when the sound is in Personal mode.
- You can press the **S.MODE** button on the remote control to change the Sound Mode directly.

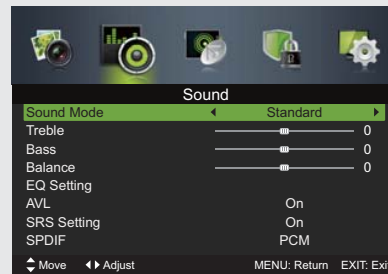

Sound Mode:

Allows the selection of an audio-enhancement technical from among the following options: Standard, Music, Movie and Personal. You can change the value of Treble and Bass when the sound is in Personal mode.

Treble

Controls the relative intensity of higher-pitched sounds.

Bass

Controls the relative intensity of lower-pitched sounds.

Balance

Adjusts the relative volume of the speakers in a multiple speaker system.

EQ Setting

Allows the selection of an equalizer mode: Off / Rock / Pop / Jazz / User. You can change the EQ value under User mode.

AVL

Selects to turn On/Off Audio Volume Leveler.

SRS Setting

Selects to turn On/Off Surround Sound.

SRS TruSurround HD™ (TS HD) is a robust

Basic Features

Sound management (ATV / DTV Mode)

multichannel virtualisation technology developed by SRS Labs that provides an enhanced listening experience unlike any other technology that has been offered for a two speaker playback environment. TruSurround HD builds upon its predecessor, the industry leading surround sound virtualiser, SRS TruSurround XT®. Not only does TruSurround HD process up to 6.1 channels for playback over two speakers or headphones, but it also utilises additional proprietary algorithms from SRS Labs to optimise bass performance, for deep rich bass, dialogue clarity for better intelligibility of vocals, and definition control for maximum high-frequency clarity.

SRS TruSurround HD™ creates an immersive, feature-rich surround sound experience from two speakers, complete with rich bass, high frequency detail and clear dialogue.

TruSurround HD, SRS and the  symbol are trademarks of SRS Labs, Inc.

SPDIF Mode

Select the digital audio output mode: Auto / Off / PCM.

Audio Description

Selects to turn On/Off Audio Description.

Stereo / Dual Sound Reception (ATV Mode)

When a programme is selected, press the **NICAM** button to display the sound information for the selected station.

Broadcast	On Screen Display
Mono	Mono
Stereo	STEREO
Dual	DUAL I, DUAL II, DUAL I+II

Mono sound selection

If the stereo signal is weak in stereo reception, you can switch to mono by pressing the **NICAM** button. In mono reception, the clarity of sound is improved. To switch back to stereo, press the **NICAM** button again.

Language selection for dual language broadcast

If a programme can be received in two languages (dual language), you can switch to DUAL I, DUAL II, DUAL I+II or Mono by pressing the **NICAM** button repeatedly.

DAUL I	Sends the primary broadcast language to the loudspeakers
DAUL II	Sends the secondary broadcast language to the loudspeakers
DAUL I+II	Sends the primary and secondary broadcast languages to the loudspeakers

Channel management (ATV / DTV Mode)

Auto Scan

Use this to automatically find and store all available channels. This is normally recommended if some channels have been added or removed by the broadcaster or you have moved house.

1. Press the **MENU** button to display the main menu. Press the **◀▶** buttons to select **Channel** in the main menu, then press the **▼** or **OK** button, it will highlight the first option.

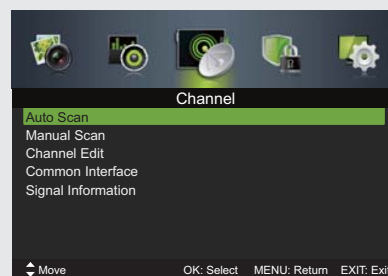

2. Press the **▲▼** buttons to select Auto Scan and then press the **OK** button to enter sub-menu.



3. Press the **◀▶▲▼** buttons to navigate the menu and change the settings.

Country

Selects the country where you will operate the TV.

Mode

Selects the auto scan mode: DTV+ATV/DTV/ATV. (DTV mode)

Start

Press the **OK** button to start auto tuning.

Basic Features

Channel management (ATV / DTV Mode)

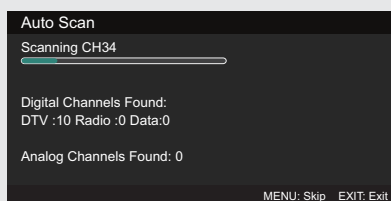

If you stop the tuning before it has finished, the TV will report a no signal error. This is normal because all previous channel memory has been cleared before tuning is carried out.

Manual Scan (DTV Mode)

Allows you to make manual fine tuning adjustments to the channel under DTV mode.

1. Press the **MENU** button to display the main menu. Press the ◀▶ buttons to select **Channel** in the main menu, then press the ▼ or **OK** button, it will highlight the first option.

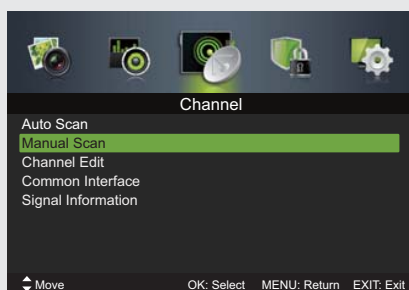

2. Press the ▲▼ buttons to select **Manual Scan** and then press the **OK** button. On the sub-menu, select Digital Manual Scan and then press the **OK** button.



Digital Scan

Press the ◀▶ buttons to select the desired channel.

Start

Press the ▲▼ buttons to select Start and then press the **OK** button to start tuning.

Manual Scan (ATV Mode)

Allows you to make manual fine tuning adjustments if the channel reception is poor under ATV mode.

1. Press the **MENU** button to display the main menu. Press the ◀▶ buttons to select **Channel** in the main menu, then press the ▼ or **OK** button, it will highlight the first option.

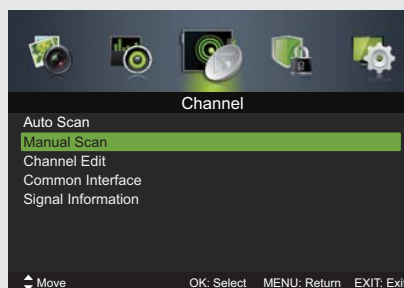

2. Press the ▲▼ buttons to select **Manual Scan** and then press the **OK** button. On the sub-menu, select Analog Manual Scan and then press the **OK** button.

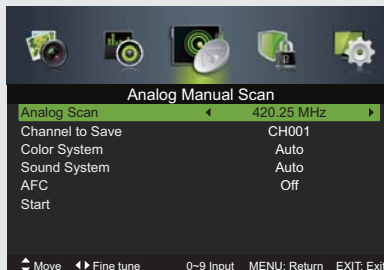

Analog Scan

Displays the current frequency, press the ◀▶ buttons to change the frequency.

Channel to Save

Press the ▲▼ buttons to select Channel to Save, press the ◀▶ buttons to select channel number you want to store.

Color System

Press the ▲▼ buttons to select Color System, press the ◀▶ buttons to select: Auto / PAL/SECAM.

Sound System

Press the ▲▼ buttons to select Sound System, press the ◀▶ buttons to select: DK/I / BG.

AFC

Press the ▲▼ buttons to select AFC, press the ◀▶ buttons to select On or Off.

Start

Press the ▲▼ buttons to select Start, press the ◀▶ buttons to start tuning.

Basic Features

Channel management (ATV / DTV Mode)

Channel Edit (DTV mode)

1. Press the **MENU** button to display the main menu. Press the ◀▶ buttons to select **Channel** in the main menu, then press the ▼ or **OK** button, it will highlight the first option.



2. Press the ▲▼ buttons to select **Channel Edit** and then press the **OK** button to enter sub-menu.

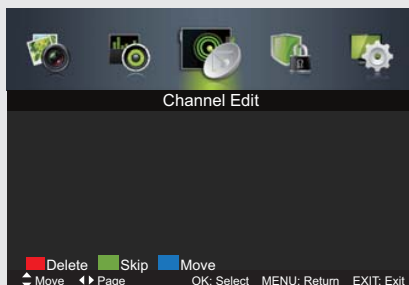

Delete

Press the **RED** button to delete the selected channel.

Skip

Press the **GREEN** button to select the channels that you want to skip when you are selecting channels. Press the **GREEN** button again to undo it.

Move

Press the **BLUE** button and then press the ▲▼ buttons to move to the selected channel. Press the **BLUE** or the **OK** button to confirm.

Channel Edit (ATV mode)

1. Press the **MENU** button to display the main menu. Press the ◀▶ buttons to select **Channel** in the main menu, then press the ▼ or **OK** button, it will highlight the first option.



2. Press the ▲▼ buttons to select **Channel Edit** and then press the **OK** button to enter sub-menu.

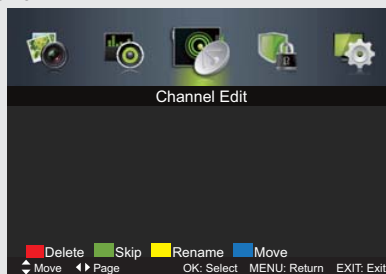

Delete

Press the **RED** button to delete the selected channel.

Skip

Press the **GREEN** button to select the channels that you want to skip when you are selecting channels. Press the **GREEN** button again to undo it.

Rename

Press the **YELLOW** button to rename the selected channel. Press the ▲▼ buttons to select the characters to represent the station name. Press the ◀▶ buttons to move to the next character and then press the **OK** button again to confirm the new name.

Move

Press the **BLUE** button and then press the ▲▼ buttons to move to the selected channel. Press the **BLUE** or the **OK** button to confirm. Press the ◀▶ buttons to select: Auto / PAL.

Favorite List

Press the **FAV** button to display the Favorite List, press the **GREEN** button to set the channel that you are currently watching as one of the favorite programmes. Press the **RED** button to delete the selected channel.

Basic Features

Channel management (ATV / DTV Mode)

Common Interface (DTV mode)

To view the module information.

1. Press the **MENU** button to display the main menu. Press the ◀▶ buttons to select **Channel** in the main menu, then press the ▼ or **OK** button.
2. Press the ▲▼ buttons to select **Common Interface** and then press the **OK** button.

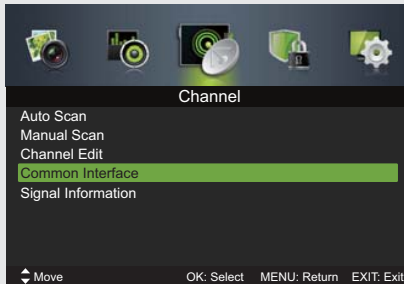

3. A Common Interface main menu will pop up. Press the ▲▼ buttons to select the items and press the **OK** button to confirm.



4. Press the **EXIT** button to exit the menu.

The common interface allows the use of a Common Access Module to enable you to view scrambled (pay to view) services. These services are provided by TopUp TV (UK only) and others. The Common Access Module and viewing card can be obtained from the service provider.



Do not repeatedly insert or remove the Common Access Module as this may damage the interface and cause a malfunction.

This feature is not available in all country.

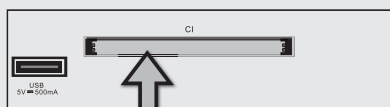

CI (Common Interface)

Allows the Common Access Module to be inserted and access the content that has been encrypted.

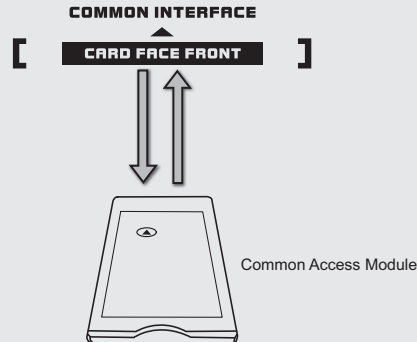

To insert the Common Access Module

1. Before you insert the Common Access Module, ensure that the TV is switched off and the viewing card is inserted *in accordance with the Service Provider's instructions*.
2. Insert the Common Access Module into the slot. Flip the Common Access Module to another side and try again if you feel resistance.
3. Switch the TV on.

To remove the Common Access Module

1. Before you remove the Common Access Module, ensure that the TV is switched off.
2. Pull the Common Access Module from the slot.
3. Switch the TV on.

Signal Information (DTV mode)

1. Press the **MENU** button to display the main menu. Press the ◀▶ buttons to select **Channel** in the main menu, then press the ▼ or **OK** button.
2. Press the ▲▼ buttons to select **Signal Information** and then press the **OK** button to view the Signal Information..

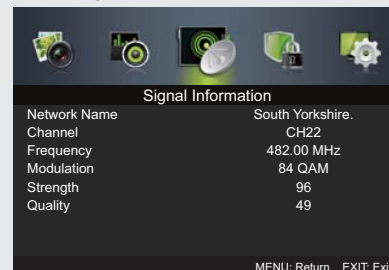

3. Press the **EXIT** button to exit the menu.

Basic Features

Lock System management

1. Press the **MENU** button to display the main menu. Press the ◀▶ buttons to select **Lock System** in the main menu, then press the ▼ or the **OK** button, it will highlight the first option.
2. Use the **0-9** buttons to input a 4-digit password to enter the Lock System menu.
3. Press the ▲▼ buttons to select the option you want to adjust in Lock System menu.
4. Press the ▲▼◀▶ buttons to change the following settings.



Default password "0000".
If you change the password, be sure to remember the new password! If you forget the new password, press the master password "8899".

Enter Password

To access the Lock System menu, you must enter the password. Enter the default password "0000" for the first time use.

Enable

The lock system is designed to prevent accidental returning of the TV/losing channels and prevent children watching unsuitable programme.

The Lock System must be set to On for this function to operate. If the Lock System is set to On, a valid password must be entered when you access Auto Scan / Manual Scan / Channel Edit / First Time Setup.

Channel Locks

Channel Locks is designed to prevent children watching unsuitable programmes. When a channel is blocked, a valid password must be entered.

Parental Rating

This function allows you to set up blocking schemes to block specific channels and ratings. Press the ◀▶ buttons to select an age rating: None, 4-18.

Lock System management

Lock Keypad

Key Lock is designed to prevent children from pressing the buttons on the TV. The Lock System must be set On for this function to operate.

New Password

Use the **0-9** buttons to input the old password and then input the new 4-digit password. Re-enter new password for confirmation.

Clear Lock

Reset all the lock settings to the factory defaults.

5. Press the **EXIT** button to exit the menu.

Setup management

OSD Language

1. Press the **MENU** button to display the main menu. Press the ◀▶ buttons to select **Setup** in the main menu, then press the ▼ or the **OK** button, it will highlight the first option.
2. Press the ▲▼ buttons to select **OSD Language** and then press the ◀▶ buttons to select your desired on-screen display language.

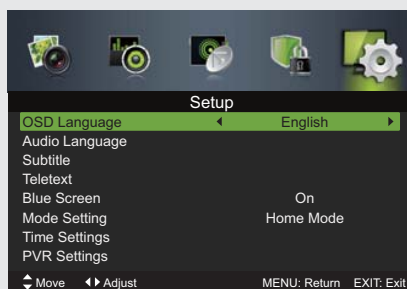

3. Press the **EXIT** button to exit the menu.

Basic Features

Setup management

Audio Languages (DTV Mode)

1. Press the **MENU** button to display the main menu. Press the ◀▶ buttons to select **Setup** in the main menu, then press the ▼ or the **OK** button, it will highlight the first option.
2. Press the ▲▼ buttons to select **Audio Languages** and then press the **OK** button.

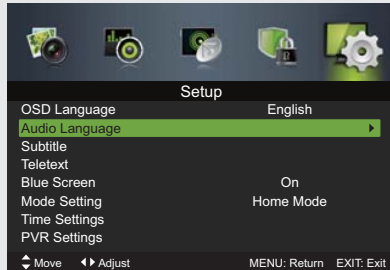

3. Press the ◀▶ buttons to select your desired Audio Primary Language. Press the ▼ button and then press the ◀▶ buttons to select your desired Audio Secondary Language.

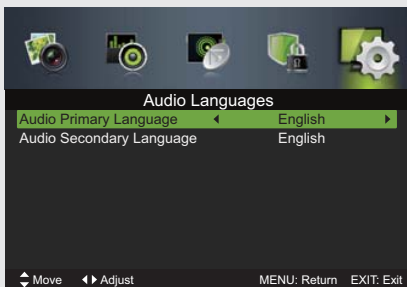

4. Press the **EXIT** button to exit the menu.

Subtitle (DTV Mode)

1. Press the **MENU** button to display the main menu. Press the ◀▶ buttons to select **Setup** in the main menu, then press the ▼ or the **OK** button, it will highlight the first option.
2. Press the ▲▼ buttons to select **Subtitle** and then press the **OK** button to enter sub-menu.



Mode:

Selects to turn On/Off subtitle language.

Subtitle Primary Language

Press the ◀▶ buttons to select your desired subtitle primary language.

Subtitle Secondary Language

Press the ◀▶ buttons to select your desired subtitle secondary language.

Hearing Impaired

Press the ◀▶ buttons to turn On/Off hearing impaired.

3. Press the **EXIT** button to exit the menu.

Teletext

1. Press the **MENU** button to display the main menu. Press the ◀▶ buttons to select **Setup** in the main menu, then press the ▼ or the **OK** button, it will highlight the first option.
2. Press the ▲▼ buttons to select **Teletext** and then press the **OK** button.
3. Press the ◀▶ buttons to select your desired Digital Teletext Language. Press the ▼ button and then press the ◀▶ buttons to select your desired Decoding Page Language.

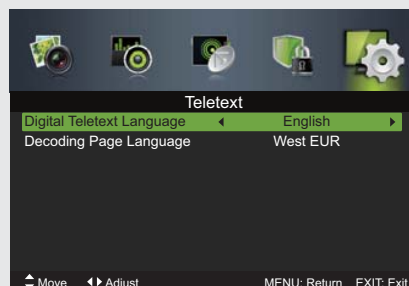

4. Press the **EXIT** button to exit the menu.

Basic Features

Setup management

Blue Screen

1. Press the **MENU** button to display the main menu. Press the ◀▶ buttons to select **Setup** in the main menu, then press the ▼ or the **OK** button, it will highlight the first option.
2. Press the ▲▼ buttons to select **Blue Screen** and then press the ◀▶ buttons to select On / Off.

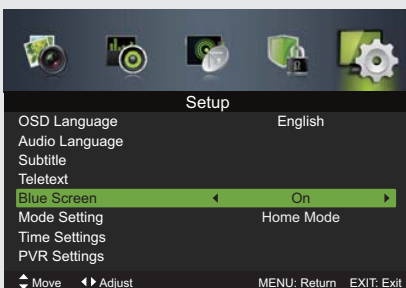

3. Press the **EXIT** button to exit the menu.

Mode Setting

1. Press the **MENU** button to display the main menu. Press the ◀▶ buttons to select **Setup** in the main menu, then press the ▼ or the **OK** button, it will highlight the first option.
2. Press the ▲▼ buttons to select **Mode Setting** and then press the ◀▶ buttons to select your desired mode: Home Mode/Store Mode.
 - Home Mode: Viewing at home.
 - Store Mode: For store demo, the brightness is higher than home mode.

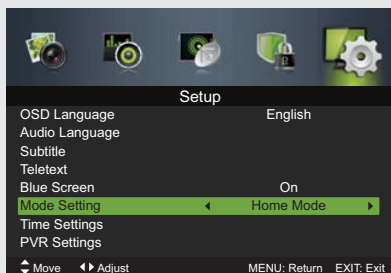

3. Press the **EXIT** button to exit the menu.

Time Settings

1. Press the **MENU** button to display the main menu. Press the ◀▶ buttons to select **Setup** in the main menu, then press the ▼ or the **OK** button, it will highlight the first option.
2. Press the ▲▼ buttons to select **Time Settings** and then press the **OK** button.

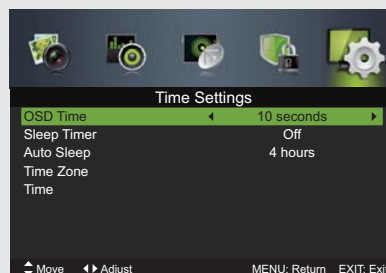

OSD Time

Displays time of the on-screen menu:
10s/20s/30s/60s/Off.

Sleep Timer

Press the ◀▶ buttons to select a period of time after which the TV automatically switches to standby mode: Off/5/15/.../120/240mins.

Auto Sleep

The unit will automatically switch to standby mode 3/4/5 hours after the last time the remote control was used. If you want to operate the TV for a long period of time, turn off the auto standby function.

Time Zone

Selects your desired Time Zone city.



Basic Features

Setup management

Time

The clock is set automatically when receiving a digital signal or you can set it manually.

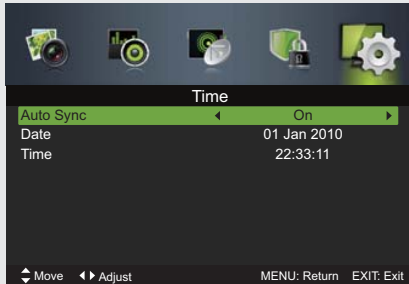

3. Press the **EXIT** button to exit the menu.

PVR Settings

1. Press the **MENU** button to display the main menu. Press the ◀▶ buttons to select **Setup** in the main menu, then press the ▼ or the **OK** button, it will highlight the first option.
2. Press the ▲▼ buttons to select **PVR Settings** and then press the **OK** button.



3. Press the ◀▶ buttons to select the following PVR File System options and then press the **OK** button.

File Manager

Select File Manager to display the recorded programme list, press the ▲▼ buttons to select the recorded programme and then press the **OK** or ▶|| button to view.

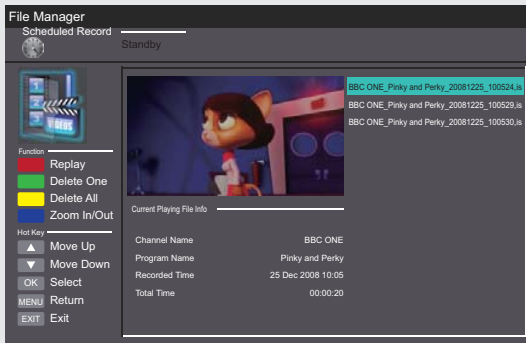

Device List

Select Device List to check the information of the connected USB storage device for PVR. Press the **RED** button to format the selected USB device.

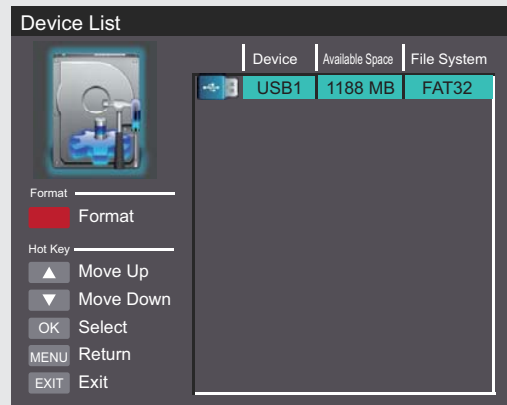

Scheduled Record

Select Scheduled Record to view the scheduled recordings list.

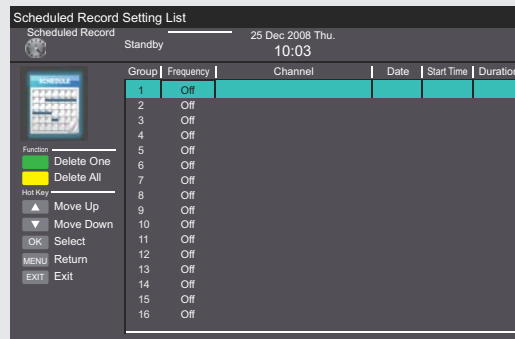

4. Press the **EXIT** button to exit the menu.

Basic Features

Setup management

First Time Setup

1. Press the **MENU** button to display the main menu. Press the ◀▶ buttons to select **Setup** in the main menu, then press the ▼ or the **OK** button, it will highlight the first option.
2. Press the ▲▼ buttons to select **First Time Setup** and then press the **OK** button.

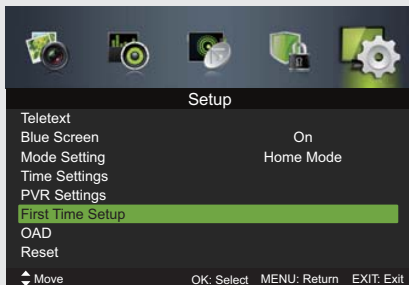

3. Press the ▲▼◀▶ buttons to navigate the menu and change the settings. Then it will search automatically for analog and digital TV programmes.
4. Press the **EXIT** button to exit the menu.

Auto Download

The TV auto detects the latest firmware through the DTV signal and upgrades the firmware automatically. Selects to turn On/Off auto OAD download.

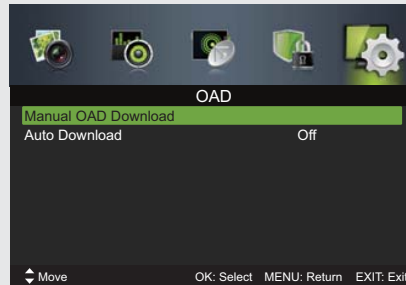

4. Press the **EXIT** button to exit the menu.

Reset

1. Press the **MENU** button to display the main menu. Press the ◀▶ buttons to select **Setup** in the main menu, then press the ▼ or the **OK** button, it will highlight the first option.
2. Press the ▲▼ buttons to select **Reset** and then press the **OK** button.

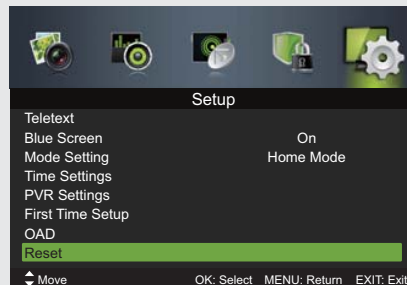

3. Press the ▲▼ buttons to select Yes or No on the screen. All settings will be reset to factory defaults and the Setup menu will disappear.

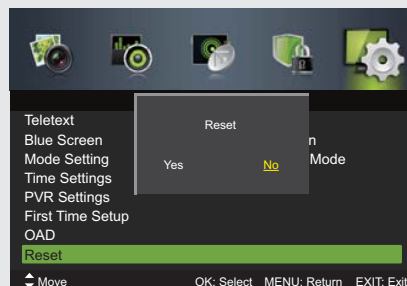

OAD (Over Air Download)

1. Press the **MENU** button to display the main menu. Press the ◀▶ buttons to select **Setup** in the main menu, then press the ▼ or the **OK** button, it will highlight the first option.
2. Press the ▲▼ buttons to select **OAD** and then press the **OK** button.

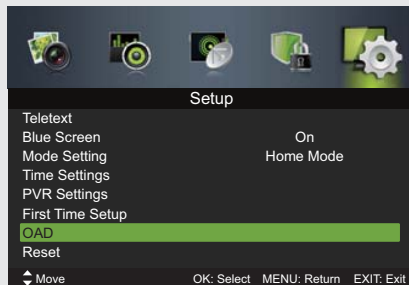

3. Press the ▲▼ buttons to select the over air download type.

Manual OAD Download

The TV auto detects the latest firmware through the DTV signal and allows you to accept or refuse the firmware upgrade service.

Entertainment

Entertainment

Using the Features via USB Port

1. Switch off the TV before connecting any USB storage device.
2. Connect your USB storage device to the USB port of your TV.
3. Press the **⏻** button at the right of the TV or the **⏻** button on the remote control to turn on your TV and your USB storage device.
4. Press the **SOURCE** button at the right of the TV or the **SOURCE** button on the remote control to display the Source List. Use the **▲** **▼** buttons to select USB and then press the **OK** button to confirm.

Attention:

- Some versions of portable hard disk may require more power than the TV USB socket can provide. To ensure correct operation please use power adapter for that device.
- If a USB hub is used make sure its mains adapter is connected to the mains supply as the total current consumption exceed 500mA.
- The maximum supported storage space of the hard disk is 1 TB.
- The file system only support FAT32 format.
- If you want to store the video streaming of a DTV programme, the transfer rate of the USB storage device must not be less than 5MB/s, otherwise the picture and sound of the programme will be affected and a warning statement will be shown on the screen. If this happens, please upgrade your USB storage device.
- The TV screen will be blank temporarily as it will take time to start up and stabilize the connected hard disk. This is normal and the starting time may vary depending on the brand and the memory size of the connected hard disk.
- Disconnect the USB storage device if it is not in use.

Viewing Photo

1. Press the **SOURCE** button at the right of the TV or the **SOURCE** button on the remote control then press the **▲▼** buttons to select the USB mode and then press the **OK** button.
2. Press the **◀▶** buttons to select **Photo** and then press the **OK** button.

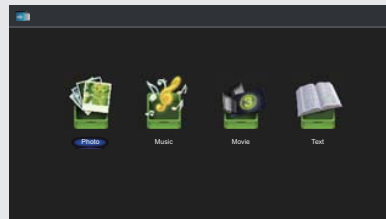

3. Press the **◀▶** buttons to select your storage device and then press the **OK** button.

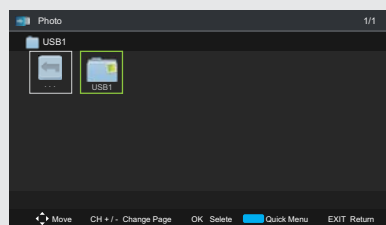

4. Press the **▲▼◀▶** buttons to navigate in the picture folder and then press the **OK** button. If you want to select the specified photos, press the **▲▼◀▶** buttons to select the picture file and then press the **OK** button.

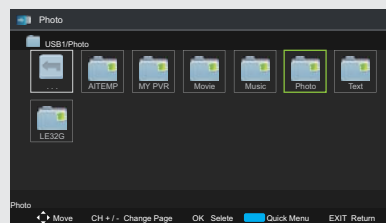
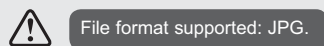

5. Press the **▶||** or **OK** button to view.

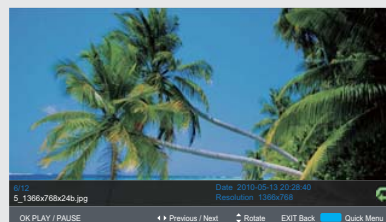

Entertainment

Entertainment

6. Press the **OK** button or the **DISPLAY** button to display the function bar: Play / Pause / Previous / Next / Rotate / Quick Menu (Interval Time / Repeat / Slideshow Effect / Background Music).



If this folder also contains music files, you can select a music track to play at the same time you view your photos.

7. Press the **EXIT** button to return to the previous menu.

Listening to Music

1. Press the **SOURCE** button at the right of the TV or the **SOURCE** button on the remote control then press the **▲▼** buttons to select the USB mode and then press the **OK** button.
2. Press the **◀▶** buttons to select **Music** and then press the **OK** button.

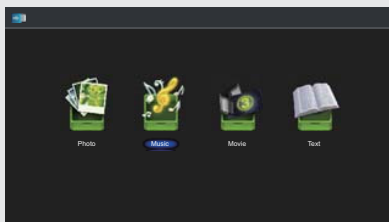

3. Press the **▲▼** buttons to select your storage device and then press the **OK** button.

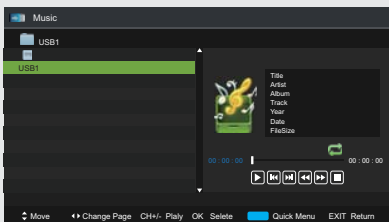

4. Press the **▲▼** buttons to navigate in the music folder and then press the **OK** button. If you want to select the specified music, press the **▲▼** buttons to select the music file and then press the **OK** button.

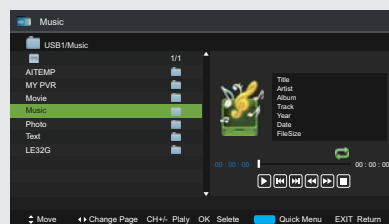

Some audio file formats will not be supported.
Supported File format: MP3.

5. Press the **▶||** or **OK** button to start to play.

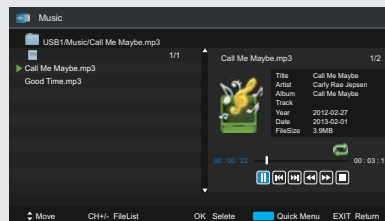

6. Press the **◀▶** buttons and then press the **OK** button to select the function: Play / Previous / Next / FB / FF / Stop / Quick Menu (Repeat).
7. Press the **EXIT** button to return to the previous menu.

Viewing Movies

1. Press the **SOURCE** button at the right of the TV or the **SOURCE** button on the remote control then press the **▲▼** buttons to select the USB mode and then press the **OK** button.
2. Press the **◀▶** buttons to select **Movie** and then press the **OK** button.

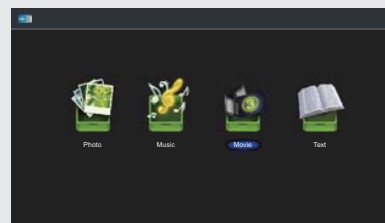

3. Press the **▲▼** buttons to select your storage device and then press the **OK** button.

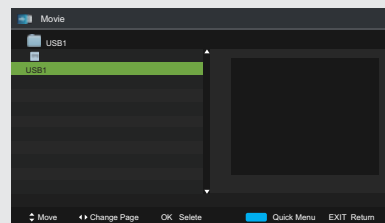

4. Press the **▲▼** buttons to navigate in the movie folder and then press the **OK** button. If you want to select the specified movie, press the **▲▼** buttons to select the movie file and then press the **OK** button.



Some audio file formats will not be supported.
Supported File format: MPEG 1/2.

Entertainment

Entertainment

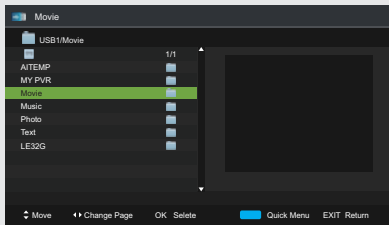

5. Press the **▶▶** or **OK** button to view.

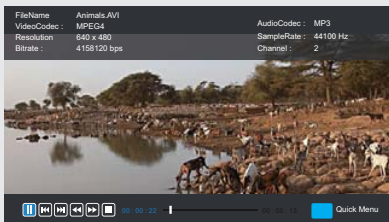

6. Press the **OK** button or the **DISPLAY** button to display the function bar. Press the **◀▶** buttons and then press the **OK** button to select the function: Pause / Previous / Next / FB / FF / Stop / Quick Menu (Repeat / Encode Type).
7. Press the **EXIT** button to return to the previous menu.

My Text

1. Press the **SOURCE** button at the right of the TV or the **SOURCE** button on the remote control then press the **▲▼** buttons to select the USB mode and then press the **OK** button.
2. Press the **◀▶** buttons to select **Text** and then press the **OK** button.

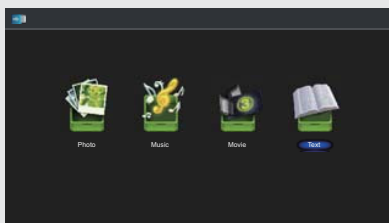

3. Press the **▲▼** buttons to select your storage device and then press the **OK** button.

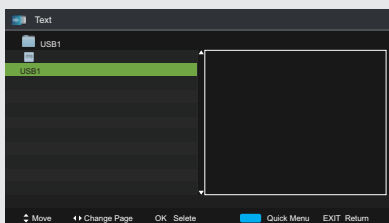

4. Press the **▲▼** buttons to navigate in the text folder and then press the **OK** button. If you want to select the specified text file, press the **▲▼** buttons to select the text file and then press the **OK** button.

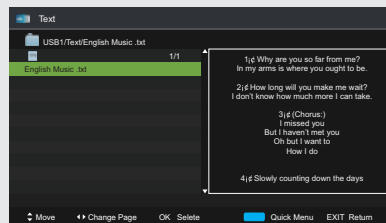
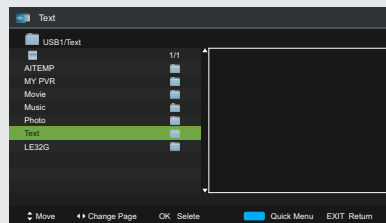

5. Press the **▶▶** or **OK** button to view.

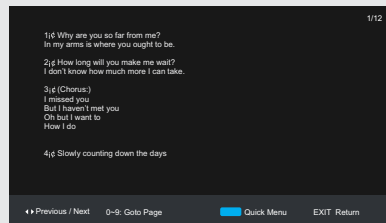

6. Press the **OK** button or the **DISPLAY** button to display the function bar. Press the **◀▶** buttons and then press the **OK** button to select the function: Previous / Next / Goto Page / Quick Menu (Repeat / Background Music / Encode Type).



If this folder also contains music files, you can select a music track to play at the same time you view your texts.

7. Press the **EXIT** button to return to the previous menu.

Other Information

Specifications

TV Broadcasting	PAL, B/G, D/K, I, SECAM, L/L'
Receiving Channels	VHF (BAND I/III) - UHF (BAND U) - HYPERBAND
Number of Preset Channels	100
Channel Indicator	On Screen Display
RF Aerial Input	75 Ohm (unbalanced)
Operating Voltage	AC 100-240V~ 50/60Hz
Audio	Nicam
Audio Output Power (WRMS.) (10% THD)	2 x 6 W
Panel Dimensions DxLxH (with foot)	205 x 646 x 441 mm
Weight (with foot)	4 kg
Panel Dimensions DxLxH (without foot)	91 x 646 x 396 mm
Weight (without foot)	3.6 kg
Energy Consumption Data	EEI A
On Mode Power Consumption (W)	30W
Standby Mode (W)	0.5W
Maximum Power (W)	45W
Standby Mode	After 4 Hours

Digital reception

MHEG-5 ENGINE compliant with ISO/IEC 13522-5 UK engine Profile 1 - for UK
Object carousel support compliant with ISO/IEC 135818-6 and UK DTT profile - for UK
Frequency range: 474-850 MHz for UK models
170-862 MHz for EU models
Transmission standard: DVB-T. MPEG-2
Demodulation: COFDM with 2K/8K FFT mode
FEC: all DVB modes
Video: MP@ML, PAL, 4:3/16:9
Audio: MPEG Layer I&II 32/44.148kHz.

We apologise for any inconvenience caused by any minor inconsistencies in these instructions, which may occur as a result of product improvements and development.

Other Information

Plug replacement - UK and Ireland only

Should you need to replace the plug; the wires in the power cable are coloured in the following way:

Blue – Neutral 'N'

Brown – Live 'L'

As the colours of the wires in the power cable may not correspond with the coloured markings identifying the terminals in your plug, and proceed as follows:

The blue wire must be connected to the terminal that is marked with the letter N.

The brown wire must be connected to the terminal that is marked with the letter L.

If the power lead is damaged, it must be replaced by a qualified electrician.

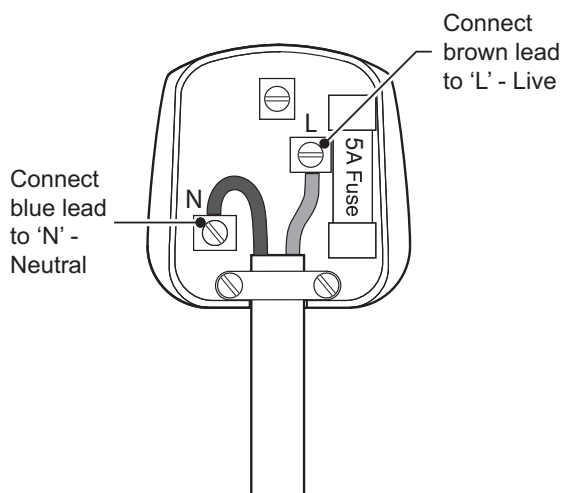

Energy label

This is called the product Fiche – the information needs to be presented in the following order, also this maybe in the form of a copy of the label, in colour or black and white – the label however must display all the information below:

- Supplier's name or trade mark
- Supplier's model product model no.
- The energy efficiency class of the model
- The visible screen diagonal in centimetres and in inches
- The on-mode power consumption
- The annual energy consumption
- The screen resolution in physical horizontal and vertical pixel count

Product Support

Trouble shooting

Image persistence - ghosting

Please note that ghosting may occur while displaying a persistent image (still or paused image). LCD TVs' image persistence may disappear after a short time. Try turning off the TV for a while. To avoid this, do not leave the screen in still picture mode for extended periods.

No power

If your TV has no power, please check the power cord plug is connect to the mains power socket.

Poor picture

1. Have you selected the correct TV system?
2. Is your TV or house aerial located too close to a non-earthed audio equipment or neon lights, etc.?
3. Mountains or high buildings can cause double pictures or ghost images. Sometimes you can improve the picture quality by changing the direction of the aerial. Is the picture or teletext unrecognisable?
4. Check if you have entered the correct frequency.
5. Please retune the channels.
6. The picture quality may degrade when two devices are connected to the TV at the same time. In such a case, disconnect one of the devices.

No picture

1. No Picture means that your TV is not receiving a transmission. Have you selected the correct button on the remote control? Try once more. Also make sure the correct input source has been selected.
2. Is the aerial connected properly?
3. Are the plugs connected tightly to the aerial socket?
4. Is the aerial cable damaged?
5. Are suitable plugs used to connect the aerial?
6. If you are in doubt, consult your dealer.

No sound

1. Has the TV been set to mute? To cancel mute, press the "M" button, or increase the volume level.
2. Sound is coming from only one speaker. Is the balance set to one extreme?

Remote control - does not operate

Your TV no longer responds to the remote control. The batteries may be exhausted, if so you can still use the control buttons on the left side of the TV.

Input sources - can not be selected

1. If you cannot select an input source, it is possible that no device is connected.
2. Check the AV cables and connections if you have tried to connect a device.

Wrong OSD language

1. Select the language in the setup menu.
2. The language for the sound or subtitles on a DVD disc cannot be changed.
3. Multilingual sound and/or subtitles are not recorded on the DVD disc.
4. Try to change the sound or subtitles using DVD's title menu. Some DVD's do not allow the user to change these settings without using the disc's menu.

Product Support

Supported file formats

Media	File Extension	Format		Supported (Maximum resolution/Bit rate etc.)
		Video	Audio	
Movie	.mpg/.dat/.vob	MPEG1	MPEG Layer 1/2/3	
		MPEG2	MPEG2	
Music	-	-	PMC	Sample Rate: 8K ~ 48KHz
	.mp3	-	MPEG 1/2 Layer 1/2/3 MP3)	Sample Rate: 8K ~ 48KHz, Bit Rate: 64K ~ 320Kbps
Photo	.jpg	Baseline JPEG		W x H = 8192 x 8192 up to 77 Mega-pixel Support format: 444/ 440/ 422/ 420/ Grayscale
		Progressive JPEG		Up to 4 Mega-pixel Support format: 444/ 440/ 422/ 420/ Grayscale

Disposal information

Instructions for waste disposal:

Packaging and packaging aids are recyclable and should principally be recycled. Packaging materials, such as foil bag, must be kept away from children.

The cold cathode fluorescent lamp in LCD PANEL contains a small amount of mercury; please follow the local laws or regulations for disposal.

Information for Users on Disposal of old Equipment and Batteries (European Union only)

These symbols indicate that equipment with these symbols should not be disposed of as general household waste. If you want to dispose of the product or battery, please consider the collection systems or facilities for appropriate recycling.

Notice: The sign Pb below the symbol for batteries indicates that this battery contains lead.



Products



Battery

Information for Users in European Union Countries

This symbol on the product or on its packaging means that your electrical and electronic device should be disposed of at the end of its service life separately from your household wastes. There are separate collection systems for recycling in EU.

For more information, please contact the local authority or the dealer where you purchased the product.





PRODUCT GUARANTEE

This product is guaranteed against manufacturing defects for a period of



Year

This product is guaranteed for twelve months from the date of original purchase. Any defect that arises due to faulty materials or workmanship will either be replaced, refunded or repaired free of charge where possible during this period by the dealer from whom you purchased the unit.

The guarantee is subject to the following provisions:

- The guarantee does not cover accidental damage, misuse, cabinet parts, knobs or consumable items.
- The product must be correctly installed and operated in accordance with the instructions contained in this manual.
- It must be used solely for domestic purpose.
- The guarantee will be rendered invalidated if the product is re-sold or has been damaged by inexpert repair.
- Specifications are subject to change without notice.
- The manufacturer disclaims any liability for the incidental or consequential damages.
- The guarantee is in addition to, and does not diminish your statutory or legal rights.

Guarantor: Argos Ltd
489 - 499 Avebury Boulevard
Central Milton Keynes
MK9 2NW



