

BUSH

26" LCD TV



IDLCD2604HD

The Gold Technical Support Line: 1902 215 259
Personal Product Support
(Charges will apply at \$2.95 per minute)

INSTRUCTION MANUAL

INTRODUCTION

Thank you for buying this Bush product, which is designed to give you many years of trouble-free service.

You may already be familiar with using a similar unit, but please take time to read these instructions. They are designed to familiarise you with the unit's many features and to ensure you get the very best from your purchase.

Safety is important

Your safety and the safety of others is important. Therefore, please ensure you read the "Safety Instructions" before you operate this unit.

Warranty

In the unlikely event that your product fails to work normally, please call the below Bush warranty number to discuss the problem with one of our qualified service engineers.

Australia

Bush Warranty: 1800 509 394

New Zealand

Bush Warranty: 0800 450 259

CONTENTS

1. INTRODUCTION.....	1
2. SAFETY INSTRUCTIONS.....	3
3. INSTALLATION.....	4
WALL MOUNTING INSTALLATION GUIDLINES.....	4
ACCESSORIES.....	5
FRONT PANEL.....	5
KEY BOARD.....	6
REAR PANEL.....	6
ANTENNA CONNECTION.....	7
CONNECTING TO PC.....	8
PC PRESET.....	9
CONNECTING TO AV EQUIPMENTS.....	10
4. REMOTE CONTROL.....	11
BATTERY INSTALLATION.....	11
KEYS FUNCTION.....	12
5. OPERATION.....	13
BASIC OPERATION.....	13
TELETEXT.....	14
EPG.....	15
MENU OPERATION.....	16
6. TROUBLESHOOTINGS.....	21
7. TECHNICAL SPECIFICATION.....	22
8. WARRANTY.....	23

SAFETY INSTRUCTIONS

1. Do not use this apparatus near water.
2. Clean only with dry cloth.
3. Do not block any ventilation openings. Install in accordance with the manufacturers instructions.
4. Do not install near any heat sources such as radiators, heat registers, stoves, or other apparatus (including amplifiers) that produce heat.
5. Protect the power cord from being walked on or pinched particularly at plugs convenience receptacles, and the point where they exit from the apparatus.
6. Only use attachments/accessories specified by the manufacturer.
7. Unplug this apparatus during lightning storms or when unused for long periods of time.
8. Refer all servicing to a qualified service personnel. Servicing is required when the apparatus has been damaged in any way, such as power-supply cord or plug is damaged, liquid has been spilled or objects have fallen into apparatus, the apparatus has been exposed to rain or moisture, does not operate normally, or has been dropped.
9. The apparatus should not be exposed to dripping or splashing and no objects filled with liquids, such as vases, should be placed on the apparatus.
10. If the television is to be built into a compartment or similar enclosed, the minimum distances must be maintained. Heat build-up can reduce the service life of your television, and can also be dangerous.

ADDITIONAL SAFETY NOTES

Never tamper with any components inside the TV, or any other adjustment controls not mentioned in this manual.

All LCD-TVs are high voltage instruments. When you clean up dust or water drops on the LCD PANEL or CABINET, the power cord should be pulled out from the receptacle, then wipe the TV with a dry soft cloth.

During thunder and lightning, unplug the power cord and antenna cord to prevent damage to your TV.

All repairs to this TV should only be performed by qualified TV service personnel.

INSTALLATION NOTES

This TV can be connected to AC 100-240 Volts. 50/60 Hz. Never connect to a DC supply or any other power supply.

Locate the TV in the room where light does not strike the screen . Total darkness or a reflection on the picture screen can cause eyestrain. Soft and indirect lighting is recommended for comfortable viewing.

Allow enough space between the TV and the wall to permit ventilation.

Avoid excessively warm locations to prevent possible damage to the cabinet or premature component failure.

Do not cover the ventilation openings when using the TV.

WALL MOUNTING INSTALLATION GUIDELINES

This television can be wall mounted as follows:

- 1.Place the LCD Television onto a solid surface. Please place some soft material to over the front of the screen to avoid any damage.
- 2.Remove the screws from the lower part of the television, where the base joins to the TV, and take away the stand (put the stand somewhere safe for future use).

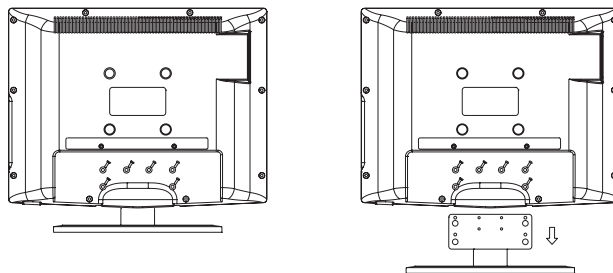

- 3.Use the four hooks provided to fix the TV onto a wall mounting bracket via the 4 VESA standard hooks on the back of the television.

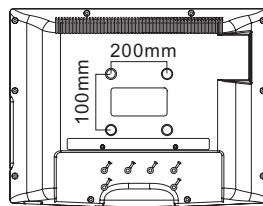

KEY BOARD

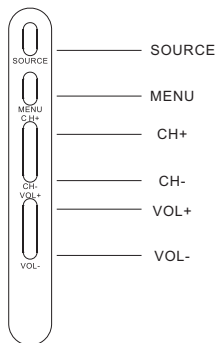

1. SOURCE
To display the input source menu.
2. MENU
To display main MENU.
3. CH+/CH-
In TV mode, to change the channel up and down.
In MENU mode, to select the menu items .
In standby mode, it can turn on the TV.
4. VOL+/VOL-
To adjust sound level.
In MENU mode, to select the menu items.

REAR PANEL

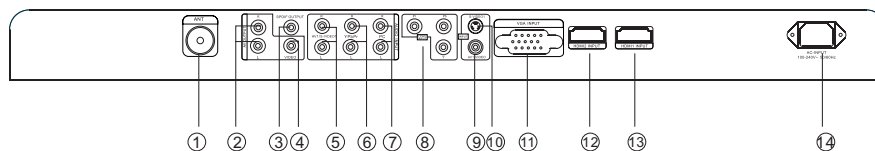

- | | | |
|-----------------------------|----------------------|--------------------|
| 1. ANTENNA | 6. YPbPr AUDIO INPUT | 11. VGA INPUT |
| 2. AUDIO OUTPUT | 7. PC AUDIO INPUT | 12. HDMI2 INPUT |
| 3. SPDIF OUTPUT | 8. YPbPr INPUT | 13. HDMI1 INPUT |
| 4. VIDEO OUTPUT | 9. AV1 INPUT | 14. AC POWER INPUT |
| 5. AV1/S-VIDEO1 AUDIO INPUT | 10. S-VIDEO1 INPUT | |

NOTE:

1. AV1 and S-VIDEO1 share one audio channel.
2. When HDMI1 port get DVI signal, the “PC Audio” channel will change to receive the audio from HDMI1 port
3. When HDMI2 port get DVI signal, the “YPbPr Audio” channel will change to receive the audio from HDMI2 port.
4. AV OUTPUT

It works only at input sources: TV,DTV,S-Video1,S-Video2,AV1,AV2.

ANTENNA CONNECTION

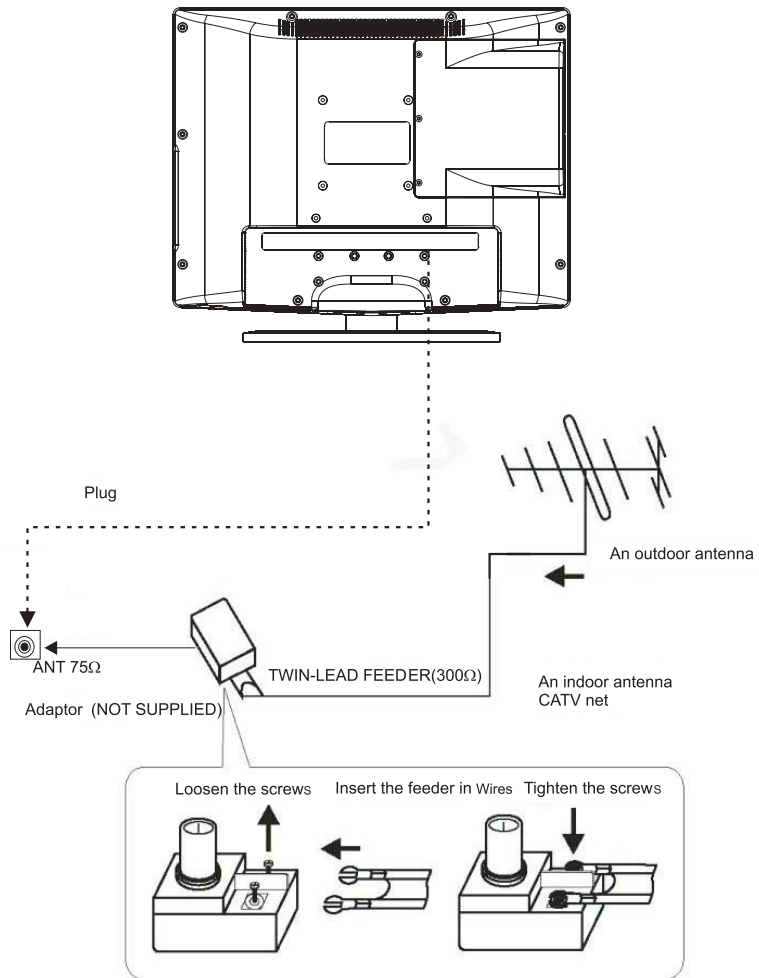

Note:
Aerial connections: IEC (female).
Input impedance: 75Ω unbalanced.

CONNECTING TO PC

STEPS:

Be sure both the TV and computer are set to Power off.

1. Connect VGA and audio cable.
2. Connect the power cord.
3. Power on the TV, switch the input source to VGA mode.
4. Power on the PC.

This sequence is very important.

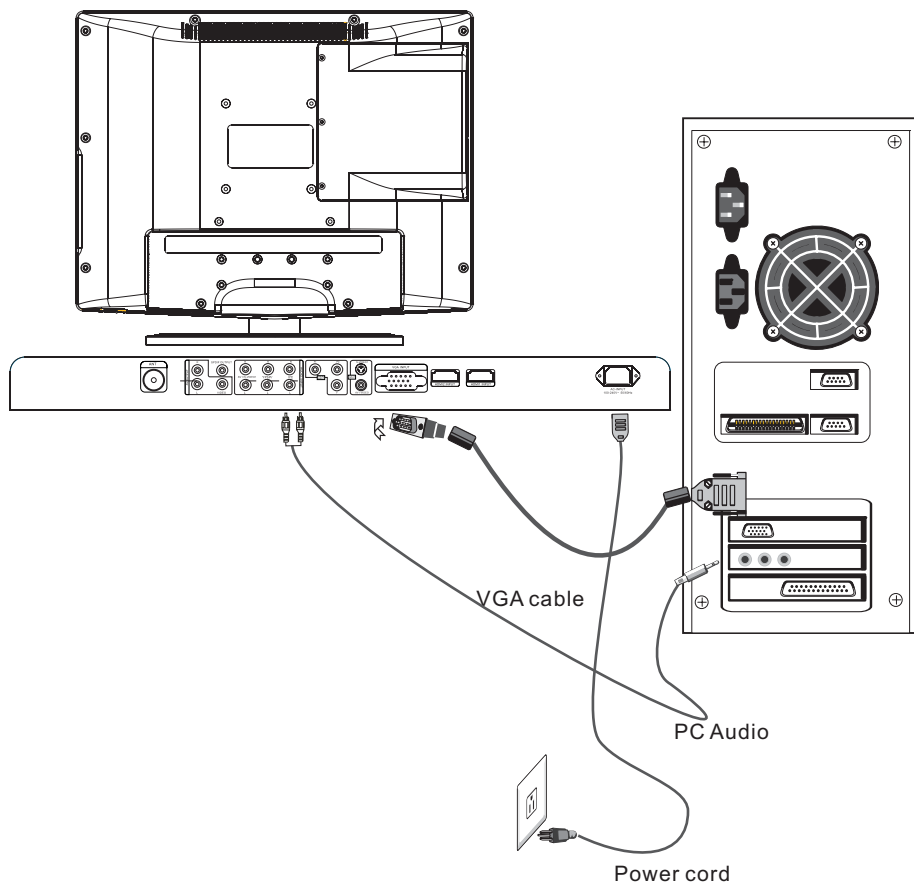

PC PRESET

PRESET MODE(recommended resolution is 1024*768@60Hz)

	RESOLUTION	V.Freq.(Hz)	H.Freq.(KHz)
1	720*400	70	31.47
2	640*480	60	31.47
3	800*600	56	35.156
4	800*600	60	37.88
5	800*600	75	46.88
6	800*600	72	48.08
7	1024*768	60	48.36
8	1024*768	70	56.48
9	1024*768	75	60.02

CONNECTING TO AV EQUIPMENTS

This TV provides two groups of AV, two S-Video, one group of YPbPr for convenient connection to VCR, DVD or other video equipment, three group of HDMI for HD signal input. Please refer to the owner's manual of the equipment to be connected as well.

You can use the input terminals on TV set rear as follows.

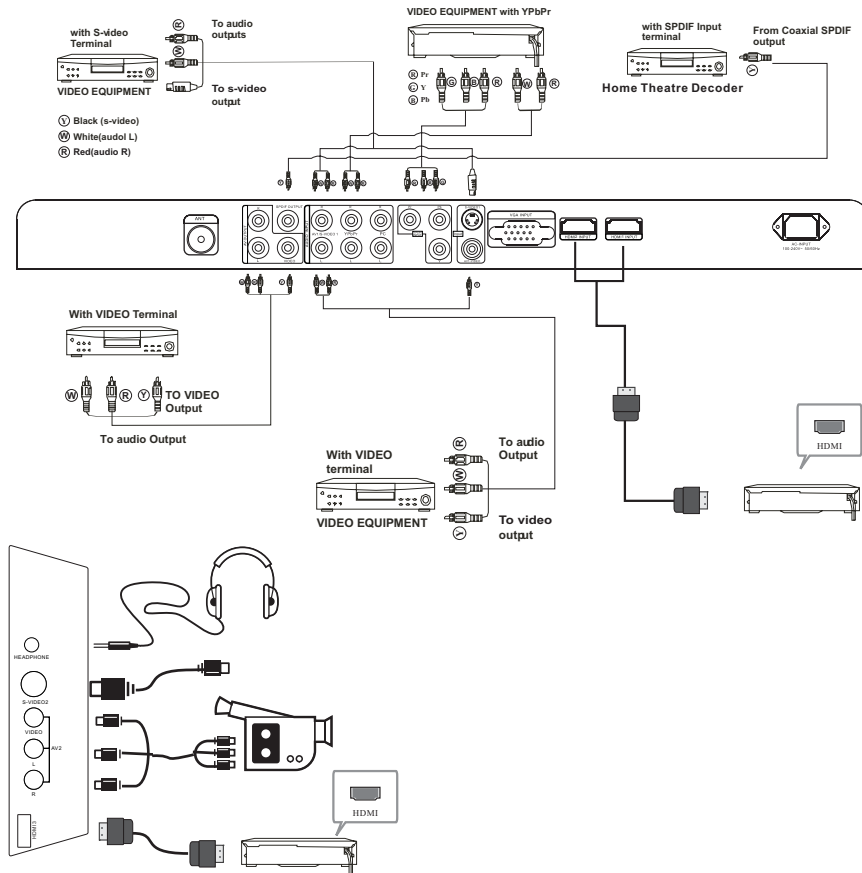

It can be connected to the following appliances: VCR, multi disc player, DVD, camcorder, video game or stereo system as well as a number of other electronic items.
YPbPr can support these video formats: 480i, 576i, 480p, 576p, 720p, 1080i, 1080p.

BATTERY INSTALLATION

1. Remove the battery cover.
2. Inserting the 2 AAA 1.5V batteries making sure the polarity (+ or -) of the batteries matches the polarity marks inside the unit.
3. Mount the battery cover. Replace with new batteries when the TV set begins to show the following symptoms: Operation is unsteady or erratic. Sometimes the TV set does not function with Remote Control Unit.

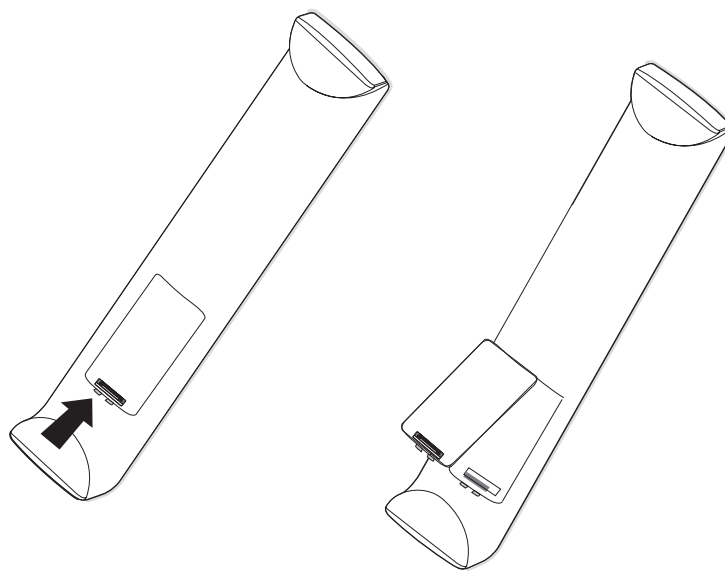

Remark:

- 1) Alkaline Battery Recommended.
- 2) Remove batteries when they are exhausted or if the remote control is not to be used for an extended period of time.

KEYS FUNCTION

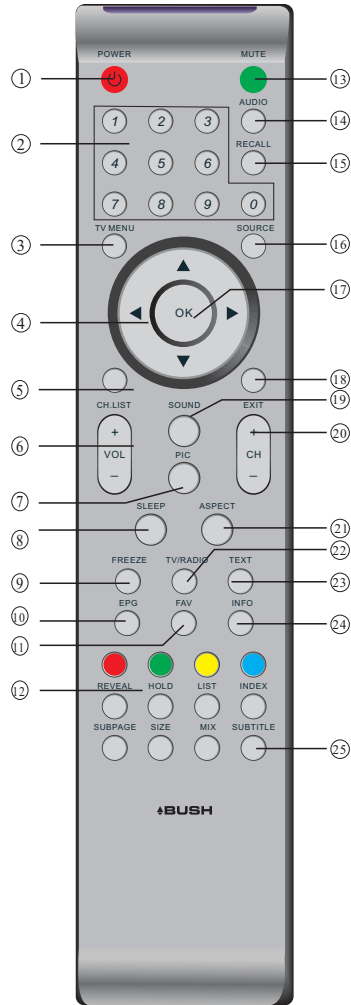

- 1: **POWER**: To set the TV to standby or power on.
- 2: **NUMERIC KEY**: For direct access to channels.
- 3: **TV MENU**: To display TV menu.
- 4: **CURSOR**: To move within the menu.
- 5: **CH.LIST**: To display the channels list.
- 6: **VOL +/-** : To adjust sound level.
- 7: **PIC**: To switch picture mode.
- 8: **SLEEP**: Set timer to turn off the TV.
- 9: **FREEZE** : To freeze the picture.
- 10: **EPG**: To display information about the program being viewed and what's on next in DTV mode.
- 11: **FAV**: To access your favourite channels list in TV or DTV mode.
- 12: **TELETEXT KEYS**: See page 14.
- 13: **MUTE**: To disable or enable the sound output.
- 14: **AUDIO**: To select the available audio language of TV programs or select sound channel.
- 15: **RECALL** : To access the previously viewed channel.
- 16: **SOURCE** : To select input source.
- 17: **OK**: To confirm selection.
- 18: **EXIT** : To exit the menu.
- 19: **SOUND**: To switch sound mode.
- 20: **CH+/CH-**: To access the next or previous channels.
- 21: **ASPECT**: To change picture aspect ratio.
- 22: **TV/RADIO**: In DTV mode, it is used to switch between digital TV channels and radio stations.
- 23: **TEXT**: To enter or exit TELETEXT.
- 24: **INFO**: To display information about the channel being viewed or further information about the program when in small EPG screen in DTV mode.
- 25: **SUBTITLE**: To switch between different subtitles in DTV mode.

BASIC OPERATION**TURN ON THE UNIT**

Press the POWER button on the remote control to switch on the power. The power indicator will light up in green colour, press the POWER button again to switch off the power, and the indicator will change to red.

CHANNEL SEARCH

Press the SOURCE button on the remote control to select the TV or DTV input mode, and press the OK button to confirm. If you are using the unit for the first time, an Installation Guide menu will be displayed to guide you through the channel scan. Use the remote control to finish channel scan (you can also refer to CHANNEL MENU (page 16) in this manual for the channel scan operation).

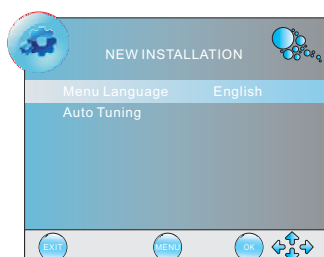
**WATCH TV PROGRAM**

Press the CH- or CH+ button to select the previous or next channels or press the 0-9 buttons to enter a channel number directly. Press CH.LIST button to view the channels list and press the ▼▲ buttons to select the desired TV programmes.

CHANGE VOLUME

Press the VOL - or VOL + button to adjust the volume level. Press the VOL - button repeatedly to decrease the volume; press the VOL + button repeatedly to increase the volume from 0 to 100.

CHANGE PICTURE MODE

Press the PIC button repeatedly to cycle through the available video picture modes.

CHANGE SOUND MODE

Press the SOUND button repeatedly to cycle through the available sound modes.

VIEW CHANNEL INFORMATION

Press the INFO button to display the preset channel information.

MUTE





Press the MUTE button to cut off the sound output, press this button again to resume sound output.

CHANGE INPUT SOURCE

Press the SOURCE button then press the ◀▶ buttons to select the input source and press the OK button to confirm.

TELETEXT

Teletext is an information system broadcast by certain channels which can be consulted like a newspaper. It also offers access to subtitles for viewers with hearing problems or who are not familiar with the transmission language (cable networks, satellite channels, etc.)

Press:	You will obtain
TEXT	This is used to enter or exit teletext mode. The summary appears with a list of items that can be accessed. Each item has a corresponding 3 digit page number. If the channel selected does not broadcast teletext, the indication 100 will be displayed and the screen will remain blank (in this case, exit teletext and select another channel).
SELECTING A PAGE ▲ ○○○○ ▼ ○○○○ ○○○○ ○	Enter the number of the page required using the 0 to 9 up/down. Example: page 120, enter 120. The number is displayed top left, the counter turns and then the page is displayed. Repeat this operation to view another page. If the counter continues to search, this means that the page is not transmitted. Select another number.
DIRECT ACCESS TO THE ITEMS ● ● ● ●	Coloured icons are displayed at the bottom of the screen. The 4 coloured buttons on the remote control are used to access the items or corresponding pages. The coloured icons flash when the item or the page is not yet available.
INDEX 	This returns to the contents page (usually page 100).
SUB PAGE 	Certain pages contain subpages which are automatically displayed successively. This key is used to stop or resume sub-page acquisition. The indication appears top left.
HOLD 	To freeze the page.
REVEAL 	To display or hide the concealed information (games solutions).
SIZE 	To zoom the page.
LIST	To save and display your favourite pages.
MIX	To mix teletext with video pictures.

EPG (Electronic Programme Guide)

The EPG (Electronic Programme Guide) menu is used to look at what is being broadcast on a DTV or Radio channel at a later point in time. Press the EPG button to access the EPG menu, the detailed programme information of the channel currently being viewed will be displayed.

PROGRAMME GUIDE		DTV 801 France 4
20 Feb 2006 16:07		1555.1625 Last Exit
DTV	20 Feb	
	16:00	17:00
800 France 2		Information
801 France 4	Last Exit	Movie 1
802 France 5		Programme 2
803 ARTE		Programme 3
804 LCP		Programme 4
805 France 3		Programme 5

To see what is going to be broadcast after the current programme, press the ► button to view future programmes and press the ◀ button to return towards the programmes televised at the current time.
 To view a different channel, press the ▼ or ▲ button. To book a wanted programme for later watching, press the blue button to enter Reminder menu. Press the green button to enter the schedule list.
 To exit the EPG menu and watch the selected channel, press the **EPG** or **EXIT** button.

MENU OPERATION

1.CHANNEL MENU

The first item of the menu is CHANNEL menu(for TV source only).

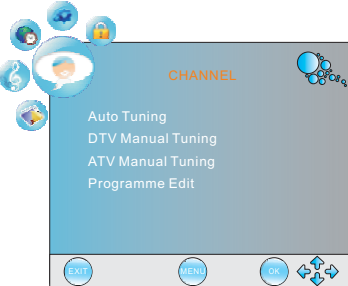

You can search channels and edit programs here.

1).Auto Tuning:Search all the channels automatically(ATV, DTV & Radio)

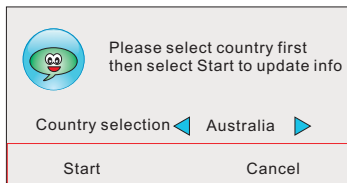

Press the ◀▶ buttons to select country then press the ▼▲ buttons to select start or cancel.

Press the OK button to start or exit auto tuning .

NOTE: All the channels including ATV, DTV and Radio can be tuned at the one time .

2).DTV Manual Tuning: You can select a DTV channel then find the program in this channel.

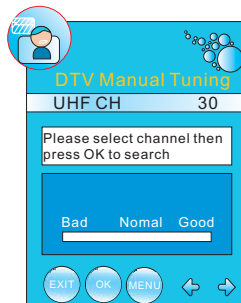

Press the ◀▶ buttons to select the channel , then press the OK button to search the programs .

NOTE: Bad Normal Good refers to the signal intensity.

3). ATV Manual Tuning : You can change the sound system to search the analog TV channels and fine tune the channels, then store the channels you selected.

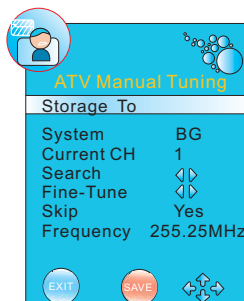

Storage To: To select the channel number you want to save to.

System: To select the TV sound system.

Current CH: To select the current channel.

Search: To search backward/forward.

Fine-Tune: To fine tuning when the signal level of current channel is weak.

Skip: When it set to Yes, the current channel will be skipped while you are changing channels by pressing the CH+ or CH- buttons.

Press the red button to store the channel after manual tuning .

4). Programme Edit: You can edit programs in the following items.

Delete

Press the red button, it will shows a red delete cursor.

Press the ▼▲ buttons to choose the program.

Press the red button again, the program will be deleted.

Rename

You can only rename ATV programs.

Move the cursor to the program, press the green button to rename the program,

Press the TV MENU button to exit edit , Press the EXIT button to exit the menu.

Move

Move the cursor to the program, press the yellow button, it will show a yellow cursor, Press the ▼▲ buttons to move the program.

Skip

Press the ▼▲ buttons to choose the program, then press the blue button to skip this program, the skip icon will show on the right side of the program.

Choose the skipped program and press the blue button again to cancel skip, the skip icon will disappear.

FAV

Press the ▼▲ buttons to choose the program, press the FAV button, it will show ♥ on the right side of the program. Choose the FAV program and press the FAV button again to cancel FAV, the ♥ icon will disappear .

Once your favourite group is created, you can press the FAV button to quickly access your favourite channel list.

2. PICTURE MENU

The second item of the menu is PICTURE menu.

You can adjust picture effect here, including contrast, brightness and colour as well as other picture functions.

Press the ▼▲ buttons to select items and press the ◀▶ buttons to adjust.

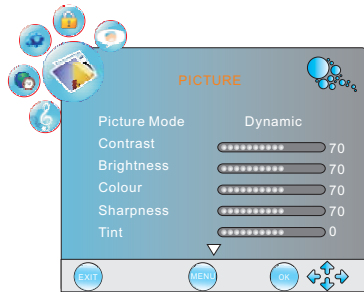

(1)

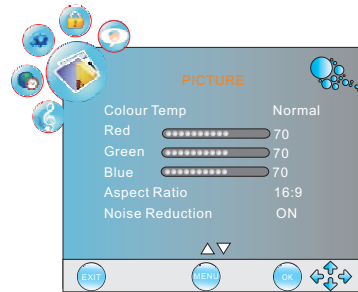

(2)

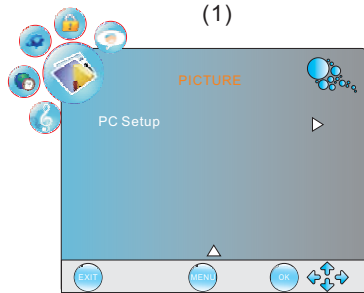

(3)

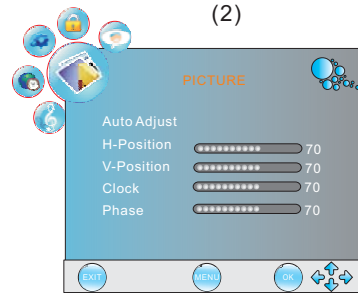

(4)

NOTE:

- 1). Tint is available in NTSC system only.
- 2). PC Setup is available in VGA mode only.

3. SOUND MENU

The third item of the menu is the SOUND menu.

You can adjust the sound effect here, including treble, bass and balance as well as other sound functions.

Press the ▼▲ buttons to select and press the ◀▶ buttons to adjust.

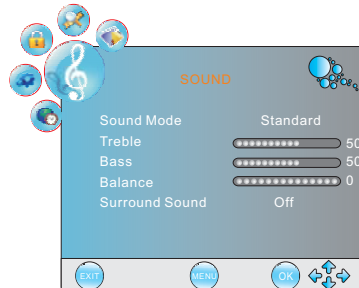

4.TIME MENU

The fourth item of the menu is the TIME menu. You can adjust the clock, power on/off time, sleep timer and time zone as well as other time clock functions. Press the ▼▲ buttons to select and press the ◀▶ buttons to adjust.

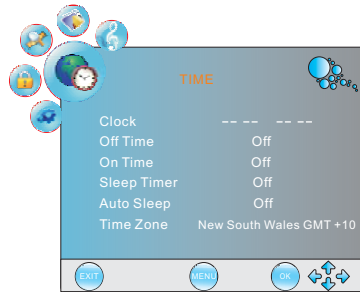

NOTE:
When the Auto Sleep is set to ON, the unit will turn to standby mode automatically if there is no signal input for a period of about 15 minutes.

5.DEFAULT MENU

The fifth item of the MENU is the DEFAULT menu. In this menu, you can adjust the Hearing impaired function only.

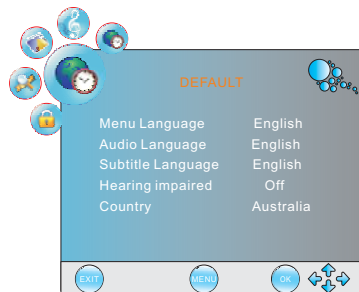

6.LOCK MENU

The sixth item of the menu is the LOCK menu. You can lock system, set password, block program, set parental guidance, restore factory default and set maximum volume control.

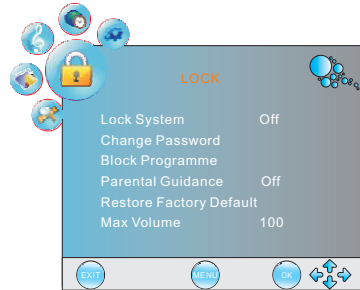

To enter the LOCK menu, the password will be requested, the default password is **6666**

LOCK System:

Press the ◀▶ buttons to turn ON or OFF. If it is set to ON, you will be asked to enter password when searching the channels .

Change Password:

Press the ▶ or OK button and enter the new password.

Block Programme:

Press the ▶ or OK button to enter the program list.

Press the ▼▲ buttons to select the channel you want to lock then press the green button to lock, the lock icon will appear behind the locked channel.

To unlock the channel, select the locked channel and press the green button again, the lock icon will disappear.

Parental Guidance:

Press the ◀▶ buttons to set the program rating to block some programs.

















Restore Factory Default:

Press the ▶ or OK button to restore, this operation will reset the unit to factory default and all the settings and stored channels will be cleared.

Max Volume:

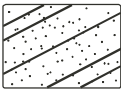
Press the ◀▶ buttons to set the maximum volume.

TROUBLESHOOTINGS

Problem		Check
Picture	Audio	
 Snow	 Noise	antenna position, direction or connection
 Ghost	 Normal audio	antenna position, direction or connection
 Interference	 Noise	electronic equipment, car/ motorcycle, fluorescent light
 Normal Picture	 Mute	Volume (check if mute is activated or if the audio system connections are not correct)
 No picture	 Mute	Power cord is not inserted Power switch is not opened Contrast and brightness/volume setup Press standby key on the remote control for inspecting
 No colour	 Normal audio	Colour control
 Picture breaking up	 Normal audio or weak	Retune channel
 No colour	 Noise	TV system

TECHNICAL SPECIFICATIONS

LCD :	
Viewing Picture Size(diagonal)	26"
Resolution	1366x768
Aspect Ratio	16:9
Display colours	16.2M
Brightness	400 CD/M ²
Contrast ratio	800:1
Response time	8 ms
View angle	160(H)/150(V)
TV:	
TV system	Digital TV: DVB-T Analog TV: PAL/SECAM
DVB-T decode	Audio: MPEG2 Audio Layer I&II Video: MPEG2 Transport MP@HL
DVB-T de-modulation	Demodulator : COFDM OFDM Mod.: 2K, 8K FFT, SFN and MFN Packed Carries: 2K/8K Guard Interval: 1/4, 1/8, 1/16, 1/32
Terminals:	
Analog RGB(VGA) Input	1
Rear HDMI Input	2
Side HDMI Input	1
Rear Composite Video Input	1
Rear S-Video Input	1
Rear Audio Input	3
Y Cb(Pb) Cr(Pr) Input	1
Side Composite Video Input	1
Side S-Video Input	1
Side HEAD PHONE Output	1
Rear Composite Video Output	1
Analog Audio Output	1
Coaxial SPDIF Output	1
Others:	
Input Power Voltage	100V-240V~ 50/60Hz
Power Consumption	130W
Audio Output Power (THD≤7%)	2x8W

WARRANTY

Please keep your receipt as proof of purchase. This product is under one year warranty for any defects in the materials or workmanship, after the original date of purchase. This product is for normal domestic and office use only. This warranty does not cover damage from misuse or neglect, accidental damage, vermin infestation, excessive voltages such as lightning or power surges or any alteration that affects the performance or reliability of the product.

In the unlikely event that your product fails to work normally, please contact **Bush Warranty on 1800 509 394 (Australia) or 0800 450 259 (New Zealand)** and have your receipt of purchase on hand.

This warranty is subject to the following provisions:

- It is only valid within boundaries of the country of purchase;
- The product must be correctly assembled and operated in accordance with the
● Instructions contained in the manual;
- This product must be used solely for domestic purposes;
- The warranty does not cover accidental damage;
- The warranty will be rendered invalid if the product is resold or has been damaged
By inexpert repair;
- The manufacturer disclaims any liability for incidental or consequential damaged.

This warranty is in addition to, and does not diminish, your statutory or legal rights.

PO BOX 6287

Silverwater NSW 1811

www.bushaustralia.com.au

Bush Warranty: 1800 509 394 Australia

Bush Warranty: 0800 450 259 New Zealand