

47" 3D LCD-TV

C47111DVB-3D

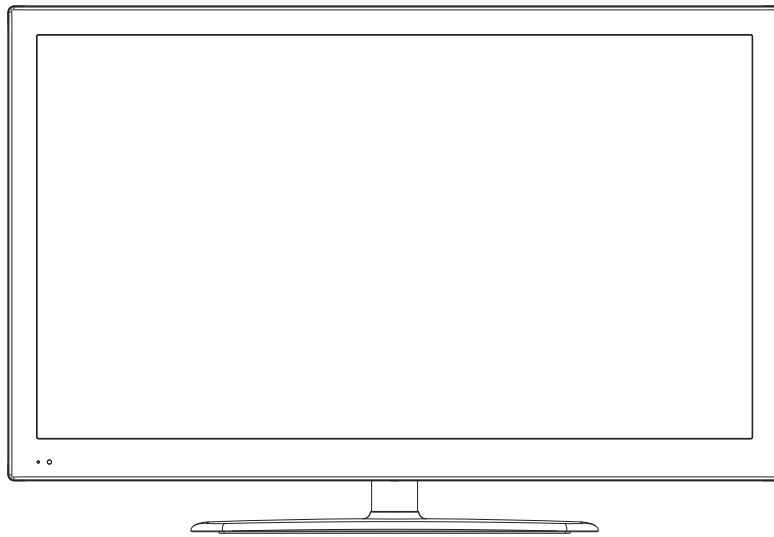

User Guide

Contents

SAFETY INFORMATION	3
Headphone Warning.....	4
Where to install.....	4
LCD Screen.....	4
3D safety information	5
Unit and Accessories	6
Getting Started.....	6
Front view.....	6
Remote Control	7
Functions of remote control buttons.....	8
To Set the Multi-Satellite Mode button.....	9
Installing Batteries in the Remote Control	10
Using the Remote Control	10
Aerial connection	10
Connecting the TV Antenna	10
Connecting external devices	10
HDMI Lead.....	10
SCART Lead.....	10
VGA Cable.....	10
CONNECTIONS	11
PC connection.....	12
VGA, HDMI PC Connection.....	12
Connecting Video camera and Video recorder	12
Connecting an audio system	13
Connecting a DVD player.....	13
Common Interface Slot.....	14
USING YOUR COMMON INTERFACE SLOT	14
Auto installation setup	14
Power On / Off the LCD TV.....	14
Source Menu	15
Menu Settings	15
CHANNEL MENU	15
PICTURE MENU	15
SOUND MENU.....	15
TIME MENU	16
LOCK MENU.....	16
SETUP MENU	16
Channel Menu	16
Picture Menu	17
Sound Menu	18
Time Menu	18
Setup Menu	18
Lock Menu	18

Multimedia Operation.....	19
Photo	19
Music	20
Movie	20
Text.....	20
Recording Operation.....	21
Recording.....	22
TROUBLE SHOOTING GUIDE	23
TECHNICAL SPECIFICATIONS	23
TV Specifications	23
DVBS Specifications	23
3D Specifications.....	24
Wall Mounting	24
Waste Electrical Recycling	24
Correct disposal of Product.....	24

Introduction

Thank you for purchasing this LCD TV which has been designed and manufactured to give you many years of trouble free service.

You may already be familiar with using a similar product but please take time to read these instructions which have been written to ensure you get the very best from your purchase.

HDMI

HDMI (High Definition Multimedia Interface) is the next generation of digital interface. Unlike conventional connections, it transmits uncompressed digital and audio signals using a single cable. This TV supports high-definition video input via the HDMI socket on the back of the TV.

Safety is important

To ensure your safety and the safety of others, please read the safety precautions BEFORE you operate this product.

Disclaimer

The illustrations of the LCD-TV, accessories and menus shown in this User's Manual may differ from the actual product.

SAFETY INFORMATION

IMPORTANT SAFETY INSTRUCTIONS - READ CAREFULLY BEFORE USE.

Take note of the following safety information which appears on the back of the TV.



CAUTION: TO PREVENT ELECTRICAL SHOCK, DO NOT REMOVE ANY COVER SCREWS, NO USER SERVICEABLE PARTS INSIDE, REFER SERVICING TO QUALIFIED SERVICE PERSONNEL.



This symbol indicates that there are important operating maintenance instructions in the literature accompanying this unit.



This symbol indicates that dangerous voltage constituting a risk of electric shock is present within this unit.

Keep these instructions

- Do not use this TV near water.
- Clean only with a slightly damp cloth.
- Do not block any ventilation openings.
- Install in accordance with the supplied Quick Start Guide and this User Guide.
- Protect the power chord from being walked on or pinched, particularly at plugs, and the point where it exits from the TV.
- Do not allow the power chord to overhang the edge of a table.
- Unplug this TV during lightening storms or when unused for long periods of time.



WARNING! TO REDUCE THE RISK OF FIRE OR ELECTRICAL SHOCK, DO NOT EXPOSE THIS TV TO RAIN OR MOISTURE. THE TV MUST NOT BE EXPOSED TO DRIPPING AND SPLASHING AND NO OBJECTS FILLED WITH LIQUIDS SHOULD BE PLACED ON THE TV.

NOTE: No naked flames such as candles should be placed on the TV.

NOTE: When displaying the same still picture for more than 2 hours without any interruption, the picture contours of the continuously displayed contents may remain visible on screen, i.e. a persistent image remains. The same applies, when displaying for more than 2 hours:

- the same background/wallpaper
- logos, video games, computer images, Teletext
- contents with a non-filling aspect ratio (e.g. 4:3 format)

These do not represent any malfunction and will not be covered by the manufacturer's warranty

This unit has been produced according to all current safety regulations. The following safety tips should safeguard users against careless use and the dangers connected with such use.

- Although this appliance has been carefully manufactured and rigorously checked prior leaving the factory, as with all electrical appliances it is possible for problems to develop. If you notice smoke, an excessive build up of heat or any other unexpected phenomena, you should disconnect the plug from the mains power socket immediately.
- Ensure that the unit is sufficiently ventilated! Never place next to or underneath curtains!
- The mains plug or appliance coupler is used as the disconnect device, the disconnect device shall remain readily operable.
- This set should only be connected to a mains power supply which matches that stated on the label on the rear of the TV - do not attempt to connect it to any other type of supply.
- The socket - outlet must be installed near the equipment and easily accessible.
- To prevent overload, don't share the same mains supply socket with too many other items of equipment.
- Apparatus with Class 1 construction shall be connected to a mains socket outlet with a protective earth connection.
- Keep away from rodents. Rodents enjoy biting into electric flexes.
- Always hold the plug when pulling out the plug from the mains supply socket. Do not pull on the flex, the flex can become overloaded and cause a short circuit.
- Set up the unit so that no one is able to trip over the flex.
- Do not place heavy items on the flex, which may damage it.
- Take note that the flex cannot be reached and pulled by young children, avoiding injury.
- Do not set up the unit near to heat sources. The casing and the flex could be damaged by the impact of heat.
- The screen is made of plastic and can break if damage is done to it. Be careful when collecting sharp edged plastic splinters to avoid injury.
- Avoid placing the unit on any surfaces that may be subject to vibrations or shocks.
- To protect the unit during a thunderstorm unplug the AC power cable and disconnect the aerial. Caution: Do not touch the aerial (RF) connector.
- When you leave your home for long periods of time, unplug the AC power cable for safety reasons.
- The unit becomes warm when in operation. Do not place any covers or blankets on the unit in order to prevent overheating. The ventilation holes are not to be blocked. Do not set up near radiators. Do not place in direct sunshine. When placing on a shelf leave 5 cm (2") free space around the whole unit.
- Do not allow water or moisture to enter the TV. Do NOT use in wet or moist areas such as Bathrooms,

steamy kitchens or near swimming pools.

- Do not use this unit when moisture condensation may occur
- Any repairs must be carried out by qualified personnel only.
- Do not open this unit. A non-expert attempting to repair the unit could be dangerous and potentially cause a fire hazard.
- Liquids spilt into the unit can cause serious damage. Switch the set OFF and disconnect the mains power supply, then consult a qualified service person before attempting to use the unit again.
- Do NOT remove the safety covers. There are no useable or serviceable parts inside. You may invalidate the warranty. Qualified personnel must only service this apparatus.
- Do NOT tap or shake the screen, you may damage the internal circuits. Take good care of the remote control, do not drop.
- Never place hot objects or open flame sources on or close to the TV.
- High temperatures can melt plastic and lead to fires.
- To clean the TV use a soft dry cloth. Do NOT use solvents or petrol based fluids. For stubborn stains, you may use a damp cloth with dilute detergent.

Headphone Warning



Loud music can damage your hearing irreversibly, therefore do not set the volume to a high level when listening through headphones, particularly for lengthy listening periods.

Where to install

Locate the television away from direct sunlight and strong lights, soft indirect lighting is recommended for comfortable viewing. Use curtains or blinds to prevent direct sunlight falling on the screen. Place the TV on a sturdy platform of which the surface should be flat and steady. This will prevent it from falling over. Make sure the television is located in a position where it cannot be pushed or hit by objects, as pressure will break or damage the screen, and so that small objects cannot be inserted into the ventilation slots or openings in the cabinet.

LCD Screen

The LCD display panels are manufactured using an extremely high level of precision technology, however sometimes some parts of the screen may be missing picture elements or have luminous spots. This is not a sign of malfunction.

3D Safety Information

- If you watch the 3D imaging too closely or for a long period of time, it may harm your eyesight.
- Watching the TV or playing video games that incorporate 3D imaging with the 3D glasses for a long period of time can cause drowsiness, headaches or fatigue to you and/or your eyes. If you have a headache, or otherwise feel fatigued or drowsy, stop watching the TV and take a rest.
- Pregnant woman, seniors, persons with heart problems or persons who experience frequent drowsiness should refrain from watching 3D TV.
- Some 3D imaging may cause you to duck or dodge the image displayed in the video. Therefore, it is best if you do not watch 3D TV near fragile objects or near any objects that can be knocked over easily.
- Please prevent children under the age of 5 from watching 3D TV. It may affect their vision development.

Warning for photosensitization seizure:

- Some viewers may experience a seizure or epilepsy when exposed to certain factors, including flashing lights or images in TV or video games. If you or anybody from your family has a history of epilepsy or seizure, please consult with your doctor before watching 3D TV. Also certain symptoms can occur in unspecified conditions without any previous history. If you experience any of the following symptoms, immediately stop watching the 3D imaging and consult a doctor: dizziness or light headedness, visual transition or altered vision, visual or facial instability, such as eye or muscle twitching, unconscious action, convulsion, loss of conscience, confusion or disorientation, loss of directional sense, cramps, or nausea. Parents should monitor their children, including teenagers, for these symptoms as they may be more sensitive to the effects of watching 3D TV.

Risk of photosensitization seizure can be reduced with the following actions.

- Take frequent breaks from watching 3D TV.
- For those who have vision that is different in each eye, they should watch the TV after taking vision correction measures.
- Watch the TV so that your eyes are on the same level as the 3D screen and refrain from sitting too closely to the TV.
- Do not watch the 3D imaging when tired or sick, and avoid watching the 3D imaging for a long period of time.
- Do not wear the 3D glasses for any other purpose than viewing 3D imaging on a 3D TV.
- Some viewers may feel disoriented after watching 3D TV. Therefore, after you watch 3D TV, take a moment to regain awareness of your situation before moving.

Unit and Accessories

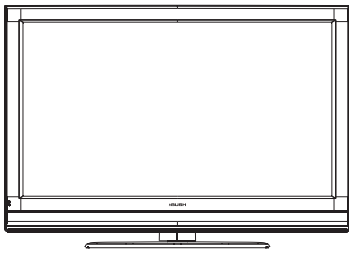

TV set



Remote Control



Batteries
for Remote
Control



4 x pol ar i zed gl asses

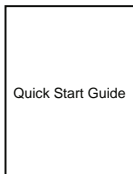

Quick Start Guide

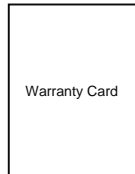

Warranty Card

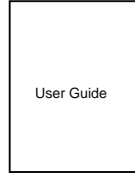

User Guide

Getting Started

Front view

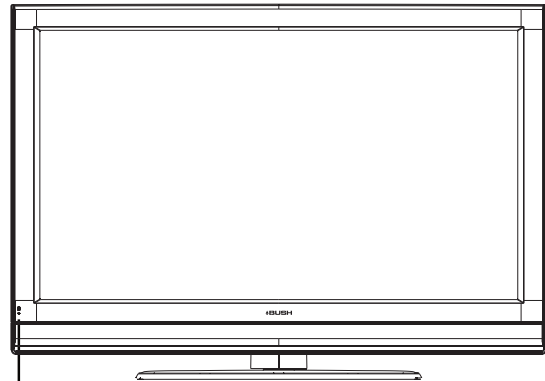

LCD Indicator
Remote Control Window
Keep clear

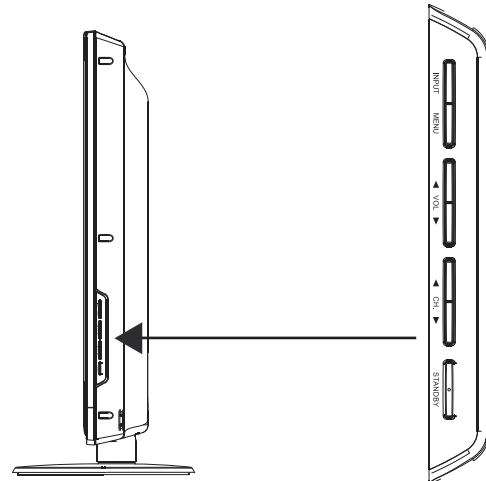

The functions of the TV buttons are described below.

- Input** : Press to display the input source menu.
- Menu** : Press to display the OSD menu, press again to exit the menu.
- CH+/-** : Press to skip through the channels.
- Vol +/-** : Press to adjust the volume.
- Standby** : Power switch.



Packaging materials are not toys. Please keep away from children. Plastic bags can cause suffocation when pulled over the head.

Remote control

Dependant on the Model of the TV some keys will have no function

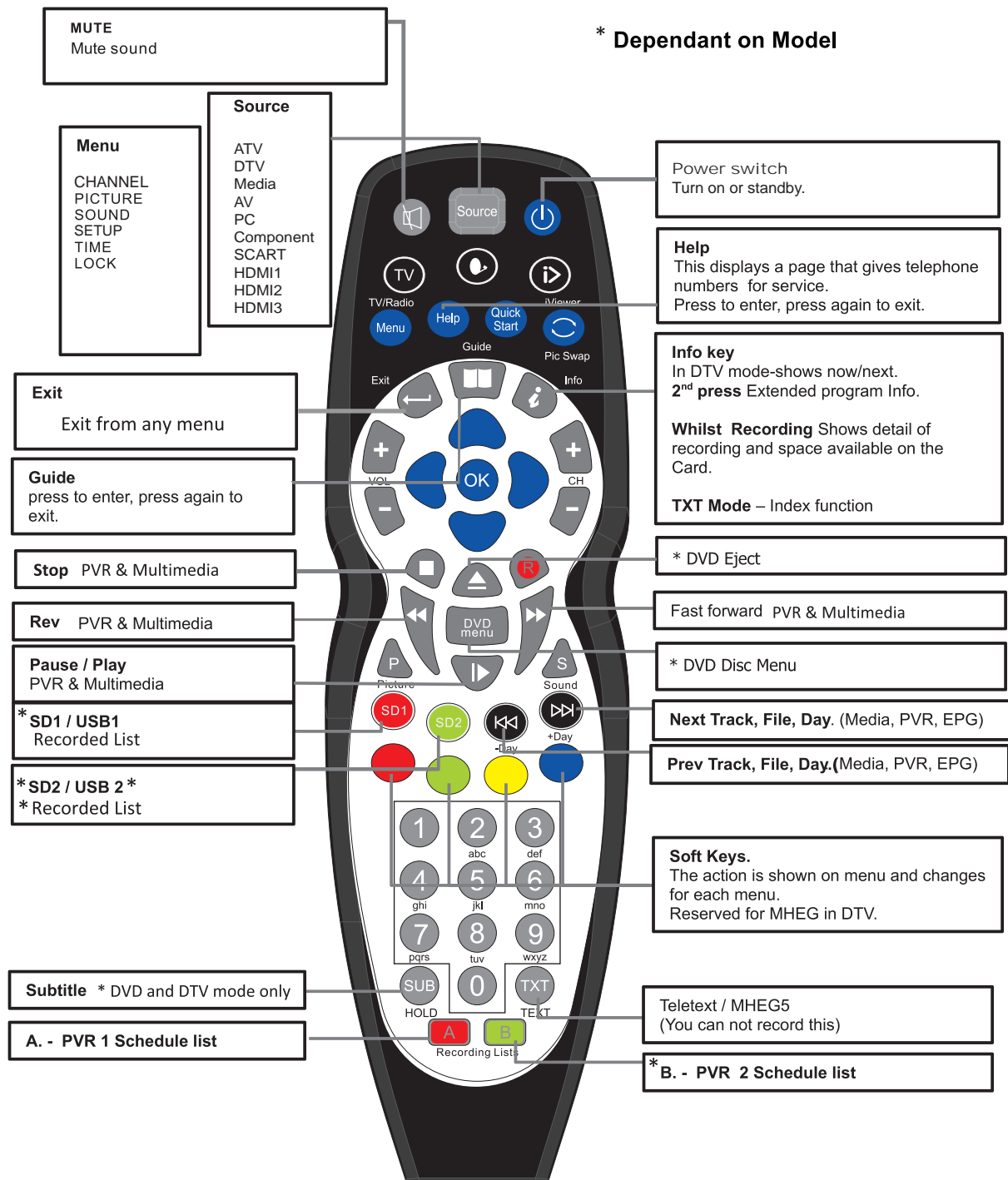

Remote control (continued)

● Functions of remote control buttons

Dependant on the model of the TV some keys will have no function

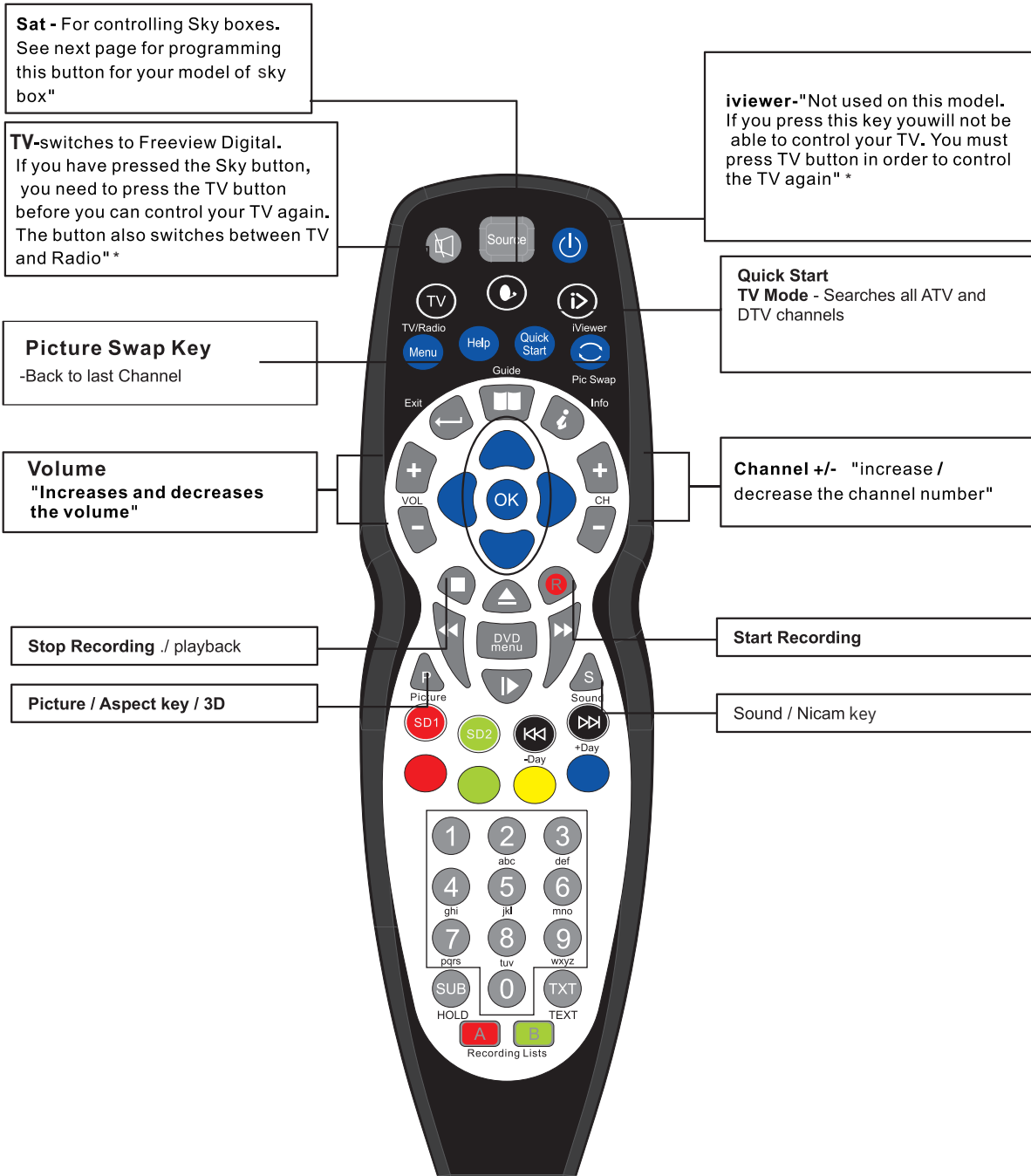

*Dependant on Model

Remote control (continued)

Dependant on the model of TV some keys will have no function

*Dependant on Model



TV This button puts the Remote in TV control mode

Sat This button puts the Remote in a Multi Satellite control mode
* A number of modes are available. See below for details

i> This button puts the Remote into an Internet Player mode
*This is only used on some TVs and Digital Boxes

To Set the Multi-Satellite Mode button

The Sat button  is programmable in the remote and can be set as follows:

To set the button if you have no Satellite Receiver:
Press  and at the same time press 0

If you have a Satellite Receiver with Recorder (Known as "Plus" type)
Press  and at the same time press 1

If you have a Satellite Receiver with High Definition (Known as "HD" type)
Press  and at the same time press 2

If you have a normal Digital Satellite Receiver (Known as "Digital" type)
Press  and at the same time press 3

If you want to use this button to switch on the DVD Player
Press  and at the same time press 4
DVD Player only fitted on certain models.

- | | |
|---|-----------------------|
|  | + 0 ~ NO SAT RECEIVER |
|  | + 1 ~ SAT + |
|  | + 2 ~ SAT HD |
|  | + 3 ~ SAT DIGITAL |
|  | + 4 ~ DVD |

Installing Batteries in the Remote Control

1. Remove the battery compartment cover at the rear of the remote control by pushing the retaining clip forward and pulling up.
2. Install the supplied batteries, ensuring the polarity matches what is shown in the battery compartment.
3. Replace the battery compartment cover.

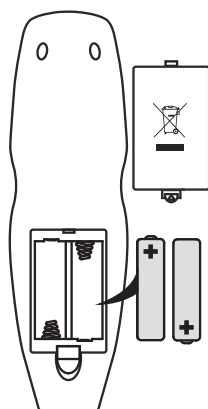

Using the Remote Control

To use the remote control point it at the TV and press the required buttons. You must be within 6 meters and at an angle of less than 30 degrees from the center of the TV.

NOTE: Sunshine or other strong light sources may interfere with the signal from the remote control. In this situation turn the TV away from the light source.



WARNING! DO NOT LEAVE BATTERIES IN THE REMOTE CONTROL FOR EXTENDED PERIODS AS THEY CAN LEAK OR CORRODE CAUSING DAMAGE TO THE REMOTE CONTROL. CHECK THEM PERIODICALLY AND REPLACE THEM AS REQUIRED.



WARNING! DO NOT MIX BATTERY TYPES. WHEN INSERTING BATTERIES, REPLACE ALL BATTERIES AT THE SAME TIME. DO NOT MIX OLD AND NEW BATTERIES.



WARNING! EXHAUSTED BATTERIES MUST BE TREATED WITH CARE AND DISPOSED OF ACCORDING TO ANY SAFETY OR RECYCLING REGULATIONS IN FORCE IN YOUR LOCAL AREA, NEVER DISPOSE OF BATTERIES INTO GENERAL WASTE, OR FIRE.



WARNING! NEVER EXPOSE BATTERIES TO EXCESSIVE HEAT SUCH AS SUNSHINE, FIRE OR THE LIKE.

Aerial connection

WARNING! ENSURE THE TV AND ALL ANCILLARY EQUIPMENT IS UNPLUGGED FROM THE MAINS BEFORE MAKING ANY CONNECTIONS!

Connecting the TV Antenna

Connect the TV antenna to the aerial socket with a 75 ohm co-axial plug. For best results use a high gain TV aerial, preferably roof or loft mounted.

- To improve picture quality in a poor signal area, purchase and install a signal amplifier.
- If the antenna needs to be split for two TVs, use a 2-Way Signal Splitter (not supplied).

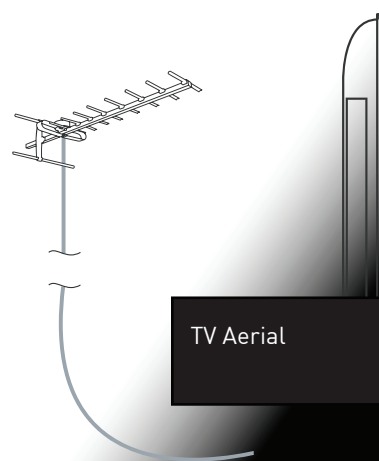

Connecting external devices

This instruction manual shows the simplest and most effective way of connecting your TV to ancillary equipment. Alternate methods are listed below.

HDMI Lead

You can connect this TV to a compatible device using a HDMI lead. This method will give the best picture.

Connect the cable from the HDMI equipment to the TV HDMI socket.

SCART Lead

You can connect this TV to a compatible device using a SCART lead. The connection uses component video signals, i.e. the red, green and blue (RGB) content of the video are sent on separate signals.

VGA Cable

You can use your TV as a monitor for your personal computer by using a VGA cable. Sound from your personal computer may also be played through the TV.

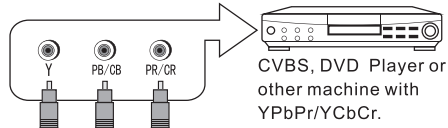
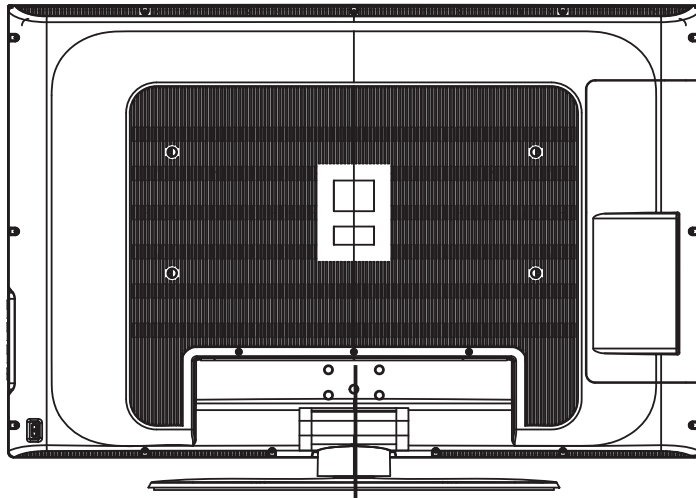

- G Green (Y)
- B Blue (Pb/Cb)
- W White (AUDIO-L)
- R Red (AUDIO-R, Pr/Cr)
- Y Yellow (VIDEO)

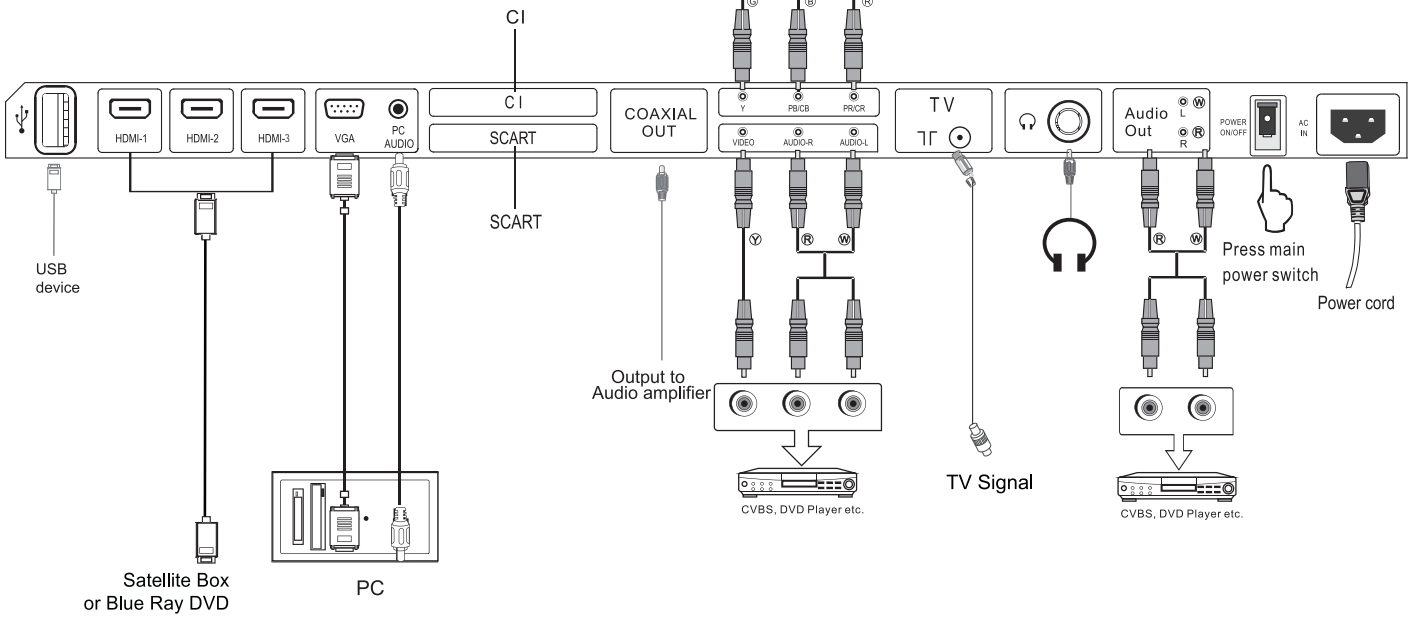

Connecting external devices (continued)

CONNECTIONS

Name	Function Description
POWER	Connect to power supply
USB	Connect to USB device for multimedia
HDMI 1, 2, 3	Connect to the HDMI socket of your DVD or Satellite Box
SCART	Connect to the Scart input / output of external devices
PC-IN	PC audio input
VGA	Connect to the PC VGA output to display PC graphics
Headphone	Connect Headphone
YPbPr	Connect to the YPbPr output on external devices
Video	Connect to the video output of external devices
L/R audio in	Audio signal input for AV (Shared with YPbPr)
TV	Connect to antenna or cable source
CI	CI slot (pay as you view card slot)
COAXIAL OUT	Output to audio amplifier
RCA audio out	Output to audio amplifier

Caution:

Before connecting external devices:

- Makes sure to disconnect the appliances from the power supply in order to avoid any potential damage from occurring.
- Make sure to establish the required connection.
- Make sure that the connectors are properly and correctly attached before connecting the appliances to the power supply.

PC connection

As PCs are sometimes still supplied with a 'conventional' CRT monitor, you may need to adjust the display settings of your PCs graphics card, otherwise the pictures may not appear correctly. Switch on your PC (still with your original monitor connected) now select the screen resolution, and select 60Hz refresh rate. Switch off your PC, then connect it to your TV while both appliances are still switched off.

VGA, HDMI PC Connection

Use a PC-VGA cable (not supplied) to connect the TV to your PC. You can also use an HDMI cable to connect to your PC (if your PC Graphic card supports HDMI). When the HDMI cable is used, the PC audio cable is no longer required. If you use the HDMI to DVI cable, you will need to use the PC audio cable. Connect all cables carefully and do not bend or break the connector pins.

When using the VGA cable

- Switch on the TV
- Switch on the PC
- Select PC/VGA as input source

When using the HDMI cable

- Select HDMI as input source

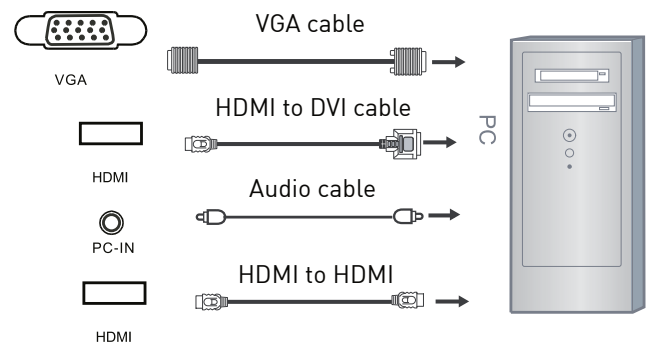

(All illustrated cables are not supplied)

Connecting Video camera and Video recorder

Video camera

- Connect the AV cable to the TV and to the video camera.
- Turn on both video camera and the TV.
- Select AV/CVBS source
- You can now see the playback picture from the video camera. Note:
- To connect the video camera using other cables, refer to the video camera instruction manual.

Video recorder

- Connect the Scart cable to the TV and video recorder.
- Turn on both video recorder and the TV.
- Select Scart source
- You can now see the playback picture from the video recorder.

Note:

- To connect the video recorder using other cables, refer to the video recorder instruction manual.

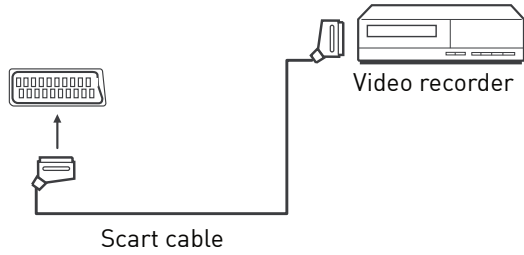

Use Scart adapter cable

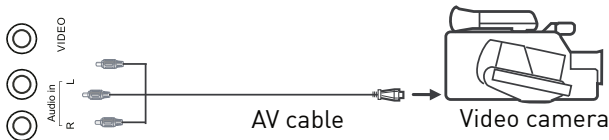

[All illustrated cables are not supplied]

Connecting a DVD player

Connect a DVD player using either a SCART cable, the HDMI cable or YPbPr cable (only if your external equipment supports HDMI).

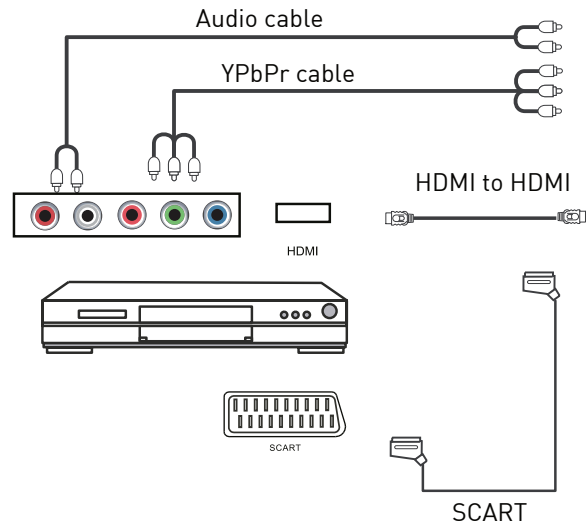

[All illustrated cables are not supplied]

Connecting an audio system

You can supply the TV sound to the stereo system (A) with the Scart socket. Use a special Scart cable SCART to RCA. (Please consult your hi-fi instructions for details). If you have a surround sound amplifier/decoder (B) Use the RCA audio cable or the special Scart cable Scart to RCA.

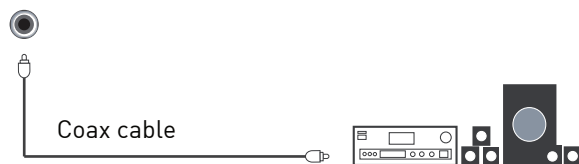
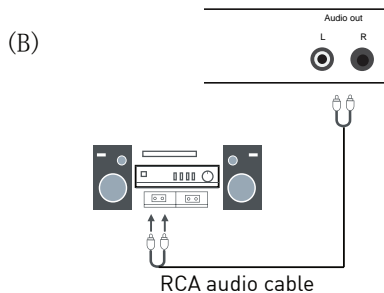
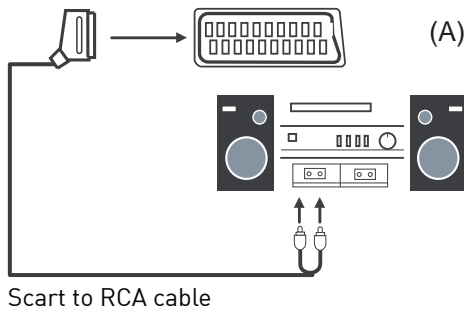

[All illustrated cables are not supplied]

When using the SCART cable

- Switch on the TV
- Switch on the DVD player
- Select SCART as input source

When using the HDMI cable

- Select HDMI as input source

When using the YPbPr cable

- Select YPbPr as input source
- Note the color of the jack
- Connect the audio jack

Common Interface Slot

USING YOUR COMMON INTERFACE SLOT

Common Interface

The Common Interface (CI) slot is designed to accept the Conditional Access Module (CAM) and Smart Card in order to view the pay TV programmes and additional services. Contact your Pay Per View TV service provider to get more information about the modules and subscriptions.

NOTE: Conditional Access Module and Smart Cards are sold separately.

WARNING! SWITCH OFF YOUR TV BEFORE ANY MODULE IS INSERTED INTO THE COMMON INTERFACE SLOT, THEN ADD THE SMART CARD TO THE CAM.

CI Slot

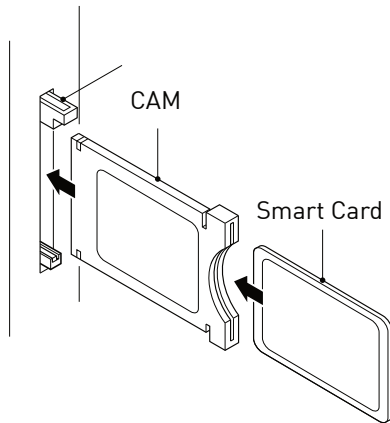

1. Turn on the TV and ensure 'DTV' Source is selected.
2. If the CAM is detected the TV will display the following message on the screen. "Common Interface Module inserted" wait for a few moments until the card is activated.
3. Select the relevant digital Pay Per View channel.
4. Detailed information on the Smart Card in use is displayed
5. Press the Ok button to access the card menu. Refer to the Module Instruction Manual for setting details.
6. When the module is removed, the following message will appear on the screen. "Common Interface module removed".

Auto installation setup

Power On / Off the LCD TV

To turn on the LCD TV

Connect the mains lead to the AC power supply and connect the aerial cable to the TV input socket. Make sure the power switch on the rear of the TV is set to ON. The standby indicator will be red.

Press the power button on the TV or the  button on the remote control, the standby indicator will turn green.

To turn off the LCD TV

Press the power button on the LCD TV or the  button on the remote control, the standby indicator will light red.

When you initially turn on the LCD TV you will see the first time installation menu as below:



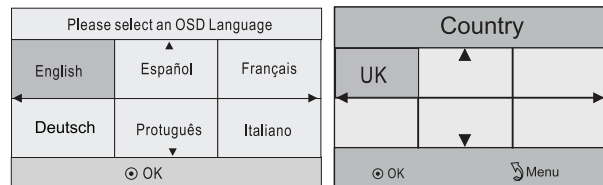

1. Connect the mains lead to the AC power supply and connect the aerial cable to the TV input.
2. Turn on the TV by pressing  on the remote control.
3. The first time you turn the TV on, it will go straight into the Quick Start menu.
4. 1st Menu using the remote control arrow buttons select your Menu language. Press OK button.
5. 2nd Menu using the remote control arrow buttons select your country, UK is selected. Press OK.
6. The tuning process will find all available ATV and DTV channels and store them.
7. By pressing the Quick Start button on the Remote control the Tuning menu can be recalled at any time.



After tuning the Target Region Descriptor will be displayed on the screen.

Target Region Descriptor

During tuning your TV may have received signals from more than one transmitter. If this has occurred the Target Region Descriptor screen will be displayed. This will enable you to select the correct regional transmission for the local news service that you require.

Press the   buttons to select the options. Press the   buttons to adjust each option's setting and then press the **OK** button to confirm.

Country Code	This will be shown as GBR for the UK.
Primary Region	This will show the regional country (England, Wales, Scotland, NI).
Secondary Region	This will allow you to set the region for your local news service on BBC and ITV (London, Beds and Cambs etc).
Tertiary Region	You may receive signals from more than one transmitter within the Secondary Region, (e.g Beds and Cambs may have Luton or Sandy Heath).

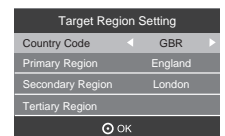

Source Menu

You can select the input source menu by pressing the Source button on the remote control or the INPUT button on the LCD TV.

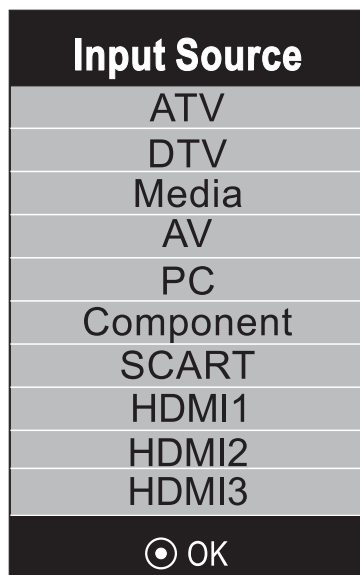

Press Source button on the remote control.

Use ▲▼ to move to the desired input source

Press  to select.

Menu Settings

1. Turn the LCD TV on.
2. Press the Menu button on the Remote Control.
3. Use the ◀ and ▶ buttons to navigate through the menu.
4. Press the Exit button to exit the Menu.

CHANNEL MENU

Allows you to search channels and set up a variety of channel options. (Select DTV source for example)

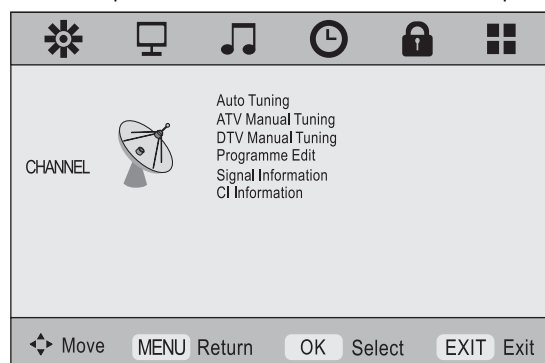

PICTURE MENU

Allows you to make adjustments to your picture settings.

(Select DTV source for example)

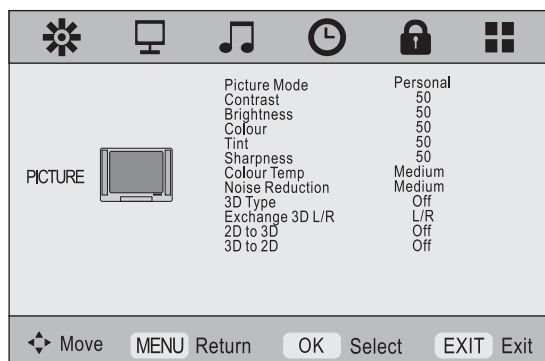

SOUND MENU

Allows you to customize the sound options and effects.

(Select DTV source for example)

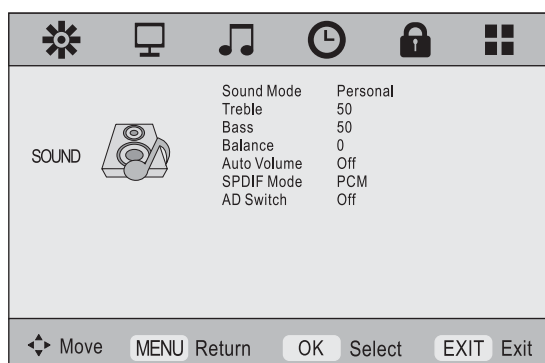

TIME MENU

Allows you to setup a variety of time options. (Select DTV source for example)

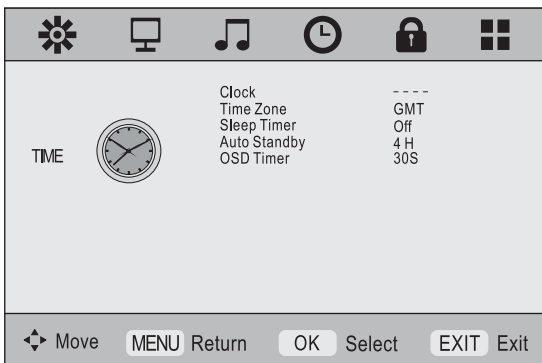

LOCK MENU

Allows you to set up a variety of lock options. (Select DTV source for example)

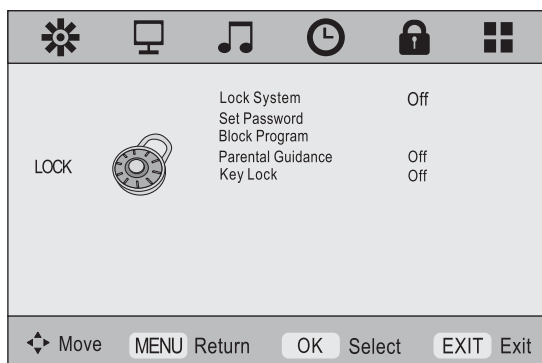

SETUP MENU

Allows you to set up a variety of options. (Select DTV source for example)

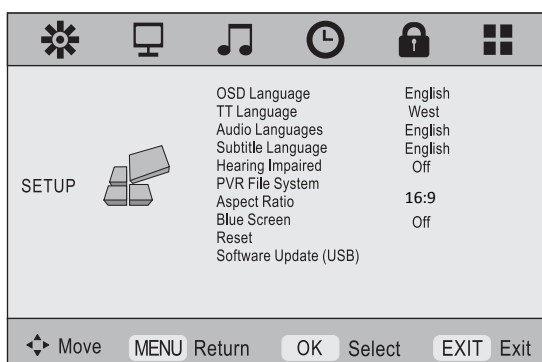

Menu Settings (continued)

CHANNEL MENU

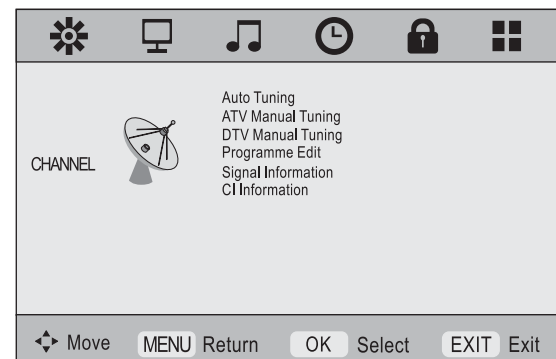

Description

Auto Tuning

Press the OK button to enter the menu, and select the Country and Tuning mode for the TV, then Press OK button to start the auto tuning.

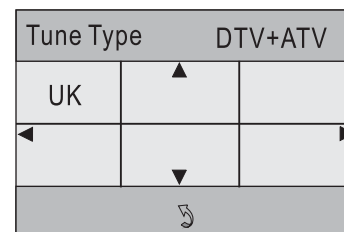

DTV Manual Tuning

Press the OK button to enter the DTV Manual Tuning menu, select a DTV channel, press the OK button to start searching.

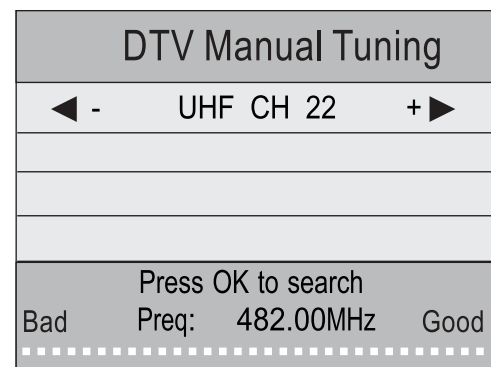

ATV Manual Tuning

Press the OK button to enter the ATV Manual Tuning menu.
 Current CH: Select the channel you want to manual tuning.
 Colour System: Select a colour system for searching.
 Sound System: Select a sound system for searching.
 Fine Tune: Press ◀/▶ button to fine-tune.
 AFC: Press ◀/▶ button to select On or Off.
 Search: Press ◀/▶ button to start search.
 Note: Press Exit button to exit menu.

Sound Menu

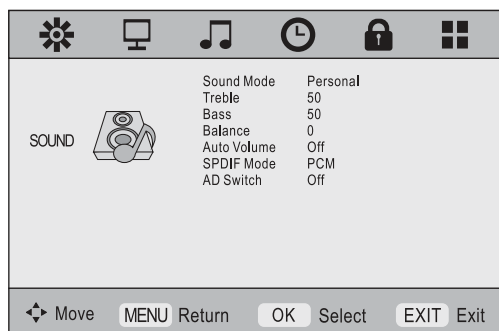

Sound Mode: Allows you to select Standard, Music, Movie, Sports or Personal. Note: Treble, Bass, Balance can only be adjusted when set in Personal mode.

Treble: Controls the relative intensity of higher pitched sounds.

Bass: Controls the relative intensity of lower pitched sounds.

Balance: Controls the volume between the left and right speaker.

Auto Volume: Controls the TV's volume automatically when ON is selected

SPDIF Mode: Choose from PCM, Auto and Off.

AD Switch: Turn on/off the AD switch function by selecting "On" or "Off".

Time Menu

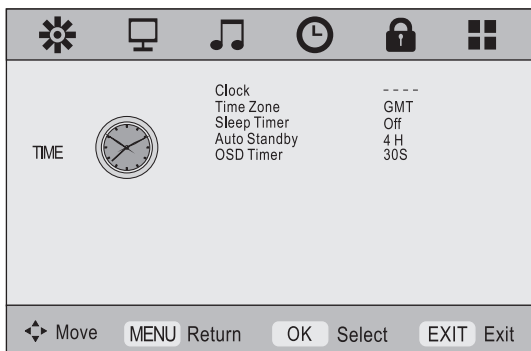

Sleep Timer: Allows you to setup the sleep timer among 10min, 20min, 30min, 60min, 90min, 120min, 180min, 240min and off

Choose your TV clock settings using the time menu options.

Setup Menu

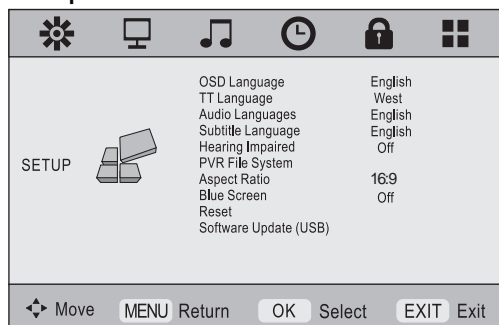

OSD Language: choose the menu language

Audio Languages (can only be selected in DTV mode): Select the audio language.

Subtitle Language (can only be selected in DTV mode): Select the subtitle language.

Hearing Impaired: Turn On/Off the hearing Impaired function.

PVR File System: Setup the PVR file System

Aspect Screen: Choose from Auto, 4:3, 16:9, Zoom1, Zoom2, Panorama.

Blue Screen: Turn On /Off the Blue Screen function.

Resete Press the OK key to restore the factory default settings.

Lock Menu

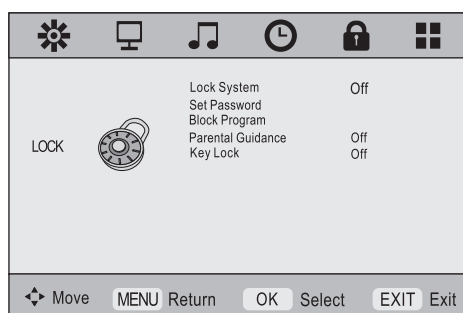

Lock System: Turn On/Off the lock system function

Note: you should enter the code to operate the menu (Default code is 0000)

Set Password: If the code has been changed you must enter the current password.

New: Enter new password

Confirm: Enter new password

If you change the password, be sure to remember the new password! If you forget use the master password "4711".

Block Program: Use ▲▼ buttons to select the channel and press the GREEN button on the remote control to lock the channel.

Note: You must enter your password to view channels that have been blocked.

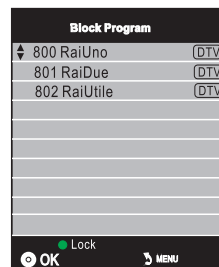

Parental Guidance: Allows you to select the parental guidance mode.

Multimedia Operation

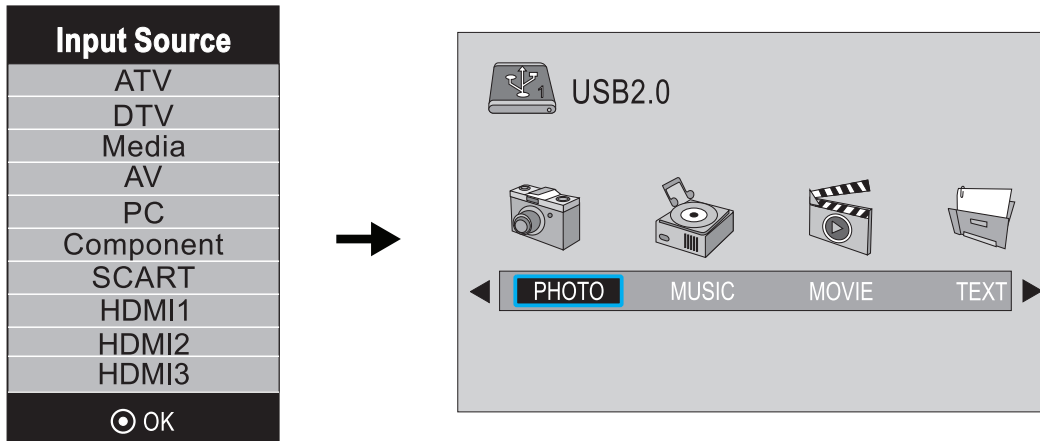

Press the source button to display the Input source menu and select Media, press the OK button to enter the USB menu as seen in picture above.

Insert USB device and select the type of files you want to listen too or view from PHOTO, MUSIC, MOVIE and TEXT. Then Press OK to enter the menu and choose the folder or file you wish to activate.

Return - Return to previous folder or menu
Press play/pause button to preview files

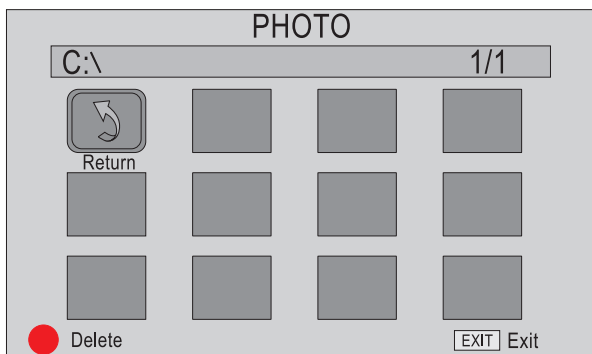

Press up/down/left/right arrow buttons to select and the OK button to activate the file or open the folder. Press **▶▶** to play the files in full screen mode. When in full screen mode press the OK button to show the navigation menu on the bottom of the screen or press stop button to return to files.

Photo

Photo viewing

Press **◀▶** buttons to select the option on the navigation resses OK to activate.

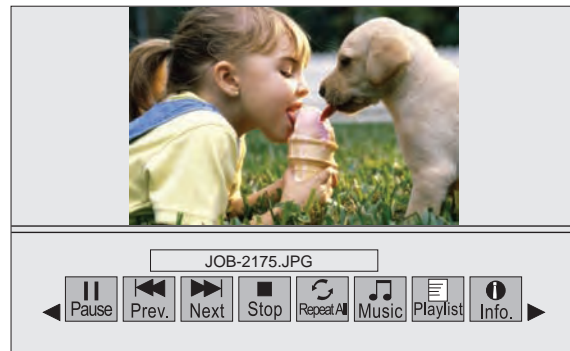

Pause: play/pause the photo viewing

Prev/Next: View the Previous or Next photo

Stop: Stop the photo viewing

Repeat: Select the repeat mode from Repeat ALL, Repeat 1 and Repeat None.

Music: Play/Pause the music

Playlist: Display the playlist on screen

Info: Display the file information

Rotate: Turn the photo clockwise or counter clockwise

Zoom: Zoom In/Out of the photo.

Move View: Move the photo in Zoom in mode.

Music

Play the music

Press ◀▶ buttons to select the option on the menu and press ▶ button to activate.

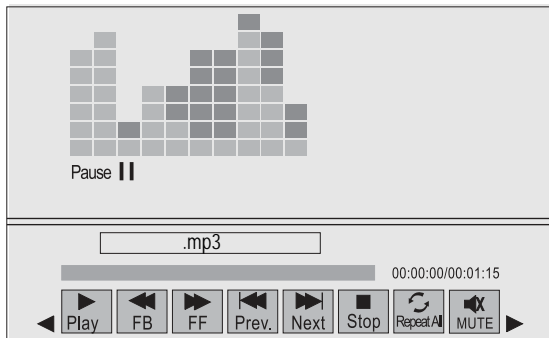

Pause: Play/Pause the music

FB/FF: Fast back and Fast forward

Prev/Next: Play the previous or next file

Stop: Stop the music

Repeat: Select from REPEAT ALL, REPEAT 1 and OFF

Mute: Mute the Audio

Playlist: Display the playlist on screen

Info: Display the file information

Goto Time: Play the music or audio book from the time you set

Movie

Play the movie

Press ◀▶ buttons to select the option on the menu and press ▶ button to activate.



Pause: Play/Pause the movie

FB/FF: Fast back and Fast forward

Prev/Next: Play the previous or next file

Stop: Stop the movie playback

Set A-B: Select and play a chosen part of the movie file by setting A as start point and B as end. Press OK button to cancel.

Playlist: Display the playlist on screen

Info: Display the file information

Slow forward: Play the movies at slow speed, press ▶ for normal playback speed.

Step forward: Step quickly through the movie using this option

Goto Time: Play the movie from the time you set

Text

View text files

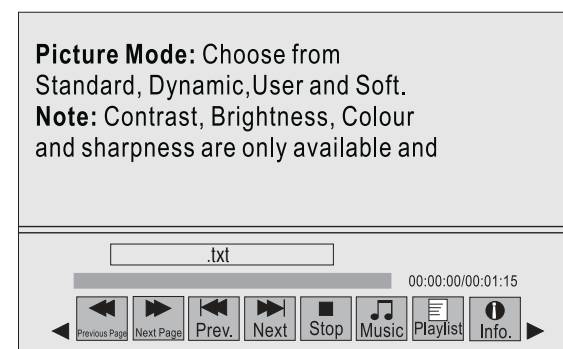

Prev/Next Page: Turn to the Previous or Next page

Prev/Next: Turn to the previous or next file

Music: Play/Pause the music programme

Playlist: Display the playlist on screen

Info: Display the file information

Stop: Stop the text viewing

Recording Operation

PVR Settings

PVR File System: Press the MENU button and select the OPTION menu, choose PVR File System and press OK.

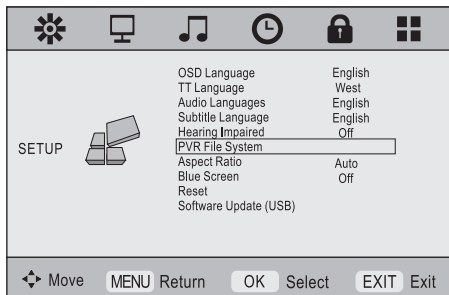

Select Disc	C:
Check PVR File System	Start
USB Disc	
Format	
Time Shift Size	
Speed	
Free Record Limit	6 Hr.
OK	MENU

Select Disc: Select the USB device to record on.

Check PVR File System: Check the system of the USB device

USB Disc: Displays information

Format: Format the USB device for PVR operating

Time Shift Size: Displays the memory size of the USB device

Speed: Displays the speed of the USB device

Free Record Limit: Set the record time limit

Recorded List

Press the SD1 button on the remote control to display the recorded list

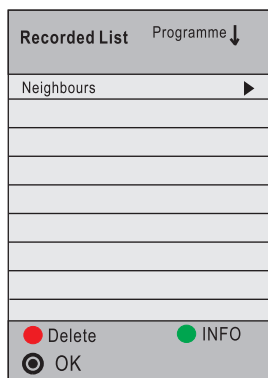

Note: Delete any scheduled recordings out of this list with the RED button.

Schedule List

Press the A button on the remote control to display the recorder schedule list

Time	Date	Programme Title	Channel Name

Note: Delete any scheduled recordings out of this list with the RED button

Timer Record

When selecting a programme in the EPG for Timer record the Recorder menu will appear. Press OK and the Timer will set automatically from the EPG data. If you choose to manually programme the Recorder menu you can.



Channel: Select the channel you want to record

Mode: Select the recording mode

Start time: Select the record time begin

End time: Select the record time end

Press the OK button to save and exit the menu

Recording

Record and Time shift function buttons

When you press the **R** Rec button the navigation menu will display on screen.

Note: Display and exit the navigation menu by pressing the **R** button. While you are recording you can press the play button and watch what has already been recorded.



Recording: Press **R** to start instant recording

Pause: Press **||** to activate the time shift function and pause live TV.

Stop: Press **■** to stop the recording or the time shift process.

Remote Control button SD1: Displays the recorded List

Remote Control button A: Displays the Recording Schedule List

Time shift

When you press the **||** Pause/Play button the picture will be paused and the navigation menu will displayed on screen



EPG Recording

Display the programme guide by pressing the GUIDE button

Select a programme to record by navigating through the EPG with the **▲▼◀▶** buttons.

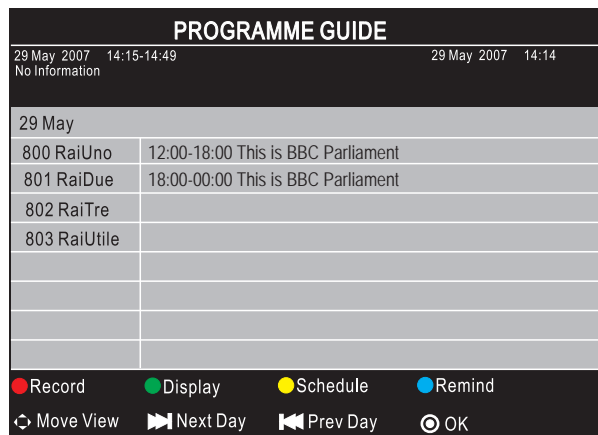

Record: Press the RED button to display the recorder menu and set the timer record. When the programme starts it will be recorded to the USB device.

Display: Press the GREEN button to display the information of the programme

Schedule: Press YELLOW button to display the recording Schedule List

Remind: Press BLUE button to display the remind menu. Once the programme starts the TV will automatically switch to this programme.

TROUBLE SHOOTING GUIDE

To assist in locating possible faults use the help guide below.

SYMPTOM	SOLUTION
No Picture, no sound	Check that the TV is correctly plugged in. Check that the TV is connected to a suitable power source. Check the electrical supply is turned on.
No Picture	Ensure that the TV is powered on. Check that the cables are fitted securely. Ensure the aerial and/or external sources are connected. Press the SOURCE button to change the source. Turn the TV on or off.
No Sound	Press the MUTE button and check if Mute mode is set. Switch to another channel and see if the same problem occurs. Press V+ button to see if the problem can be solved.
No picture on some channels	Check that correct channel is selected. Adjust the antenna.
No colour on some channels (black & white)	Check if the same problem exists on other channels. Ensure the correct picture settings are selected.
Noisy, Snowy, Ghosting picture.	Check the antenna is connected correctly. Check that the antenna is in good condition. Try moving the antenna.

If none of the suggestions seem to work, try switching your TV off and then on again. If this does not work contact our technical helpline.

NOTE: The TV must only be repaired by a qualified registered service person. Never attempt to remove the back cover as the TV has dangerous voltages inside that may cause fatality or fire.

TECHNICAL SPECIFICATIONS

Specifications of the TV that you have just purchased may vary from the information in this table due to technical innovations.

TV Specifications

TV System	PAL/BG/DK/ I
Audio System	BG/DK/I
Screen size	47" (Diagonal)
Resolution	1920 x 1080 Pixels (RGB)
Aerial input	75 Ohm (unbalanced)
Audio output power	2 x 8W
Power requirements	100-240V ~ 50/60Hz
Power consumption	Max 169W
Standby power consumption	<1W
Weight	20.7Kg

3D Specifications

Appendix: 3D formats supported by 3D video

Mode	Resolution	Refresh	3D video file that can be played	Function
Formats supported by HDMI input	1280 × 1470P	50Hz	Frame Parking (HDMI V1.4 with 3D) frame package	HDMI Frame Parking can only support the video formats of these 3 resolutions; HDMI device should support Version 1.4
	1280 × 1470P	60Hz	Frame Parking (HDMI V1.4 with 3D) frame package	
	1920 × 2205P	24Hz	Frame Parking (HDMI V1.4 with 3D) frame package	
	1920 × 720P	50/60Hz	Side by side/top bottom	
	1920 × 1080i	50/60Hz	Side by side/top bottom	
	1920 × 1080P	60Hz	Side by side/top bottom/line by line/frame alternative	
50Hz			Side by side/top bottom	
24Hz			Side by side/top bottom/line by line	
Formats supported by USB input	1920 × 1080P	30Hz	Side by side/top bottom/line by line	Other 3D formats not recommended

Remote control specifications

Type	Infrared
Control distance	5m
Control angle	30 degrees (Horizontal)
Batteries	2 x 1.5V, Size AA
Dimensions	48 x 193 x 20mm
Weight	120g (without batteries)

Wall Mounting

1. The stand must first be removed. Place the TV face down.
2. Remove the four screws on the back of the TV to release the stand.
3. Remove and store the stand and screws.
4. Use four machine screws to mount the TV on the bracket.

This unit is VESA-Compliant and designed to be wall mounted with a VESA-Compliant 600mm x 200 mm mounting kit. Mount this unit according to the instructions of the wall bracket (not supplied)

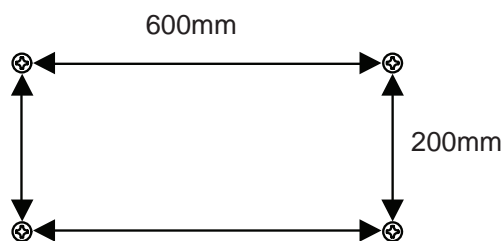

Screw size M 6 x 10

Waste Electrical Recycling

Correct disposal of Product



This sign indicates that this product may not be disposed of with your regular household waste. The recycling and separate collection of such products is your responsibility. Please drop off the above mentioned waste at a designated place for recycling waste electrical and electronic equipment. If you do not know where to drop off your waste equipment for recycling, please contact your local city office or household waste collection service.



Hg Cd Pb



Pb

If the battery or accumulator contains more than the specified values of lead (Pb), mercury (Hg), and/or cadmium (Cd) defined in the Battery Directive (2006/66/EC), then the chemicals Hg Cd Pb symbols for lead (Pb), mercury (Hg) and/or cadmium (Cd) will appear below the crossed out wheeled dust bin symbol.

By participating in separate collection of batteries, you will help to assure the proper disposal of products and batteries thus help to prevent potential negative consequences for the environment and human health.

For more detailed information about the collection and recycling programmes available in your country, please contact your local city office or the shop where you purchased this product.



This appliance complies with European Safety and Electrical directives.

It fulfills the following EU regulations:

En55013:2001+A1:2003+A2:2006

EN55020: 2007

EN61000-3-2: 2006 EN61000-3-3:1995+A1:2001+A2:2005

EN55022:2006(CLASS-A)

EN55024:1998+A1:2001+A2:2003

