



MX723/MW724
Digital Projector
User Manual

Table of contents

Important safety

instructions 3

Introduction..... 7

Projector features.....7

Shipping contents8

Projector exterior view.....10

Controls and functions11

Positioning your projector 17

Choosing a location.....17

Obtaining a preferred projected image size.....18

Connection 21

Connecting a computer or monitor...22

Connecting Video source devices.....24

Operation 27

Starting up the projector27

Adjusting the projected image28

Using the menus.....32

Securing the projector33

Switching input signal35

Magnifying and searching for details ...36

Selecting the aspect ratio37

Optimizing the image38

Setting the presentation timer43

Hiding the image.....44

Freezing the image.....44

Operating in a high altitude environment.....44

Adjusting the sound.....45

Personalizing the projector menu display46

Select the lamp saver mode.....46

Use Teaching Template..... 47

Shutting down the projector 48

Menu operation 49

Maintenance 65

Care of the projector 65

Lamp information 66

Troubleshooting..... 74

Specifications..... 75

Dimensions76

Ceiling mount installation76

Timing chart.....77

Warranty and Copyright information..... 81

Important safety instructions

Your projector is designed and tested to meet the latest standards for safety of information technology equipment. However, to ensure safe use of this product, it is important that you follow the instructions mentioned in this manual and marked on the product.

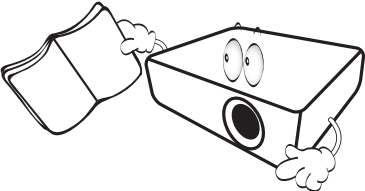
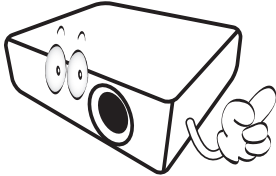
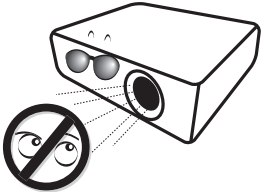
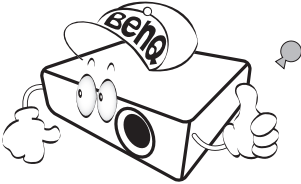
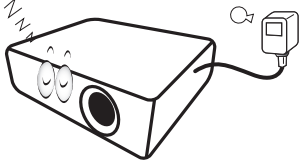
Safety Instructions	
<p>1. Please read this manual before you operate your projector. Save it for future reference.</p> 	<p>4. Always open the lens shutter or remove the lens cap when the projector lamp is on.</p> 
<p>2. Do not look straight at the projector lens during operation. The intense light beam may damage your eyes.</p> 	<p>5. In some countries, the line voltage is NOT stable. This projector is designed to operate safely within a mains voltage between 100 to 240 volts AC, but could fail if power cuts or surges of ± 10 volts occur. In areas where the mains voltage may fluctuate or cut out, it is recommended that you connect your projector through a power stabilizer, surge protector or uninterruptible power supply (UPS).</p>
<p>3. Refer servicing to qualified service personnel.</p> 	<p>6. Do not block the projection lens with any objects when the projector is under operation as this could cause the objects to become heated and deformed or even cause a fire.</p> 

Safety Instructions (Continued)

7. The lamp becomes extremely hot during operation. Allow the projector to cool for approximately 45 minutes prior to removing the lamp assembly for replacement.

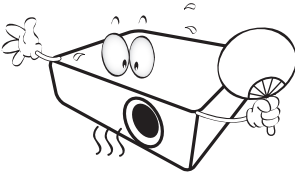

8. Do not operate lamps beyond the rated lamp life. Excessive operation of lamps beyond the rated life could cause them to break on rare occasions.

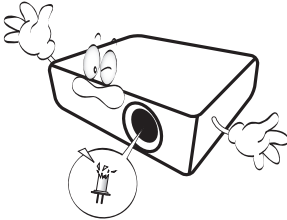

9. Never replace the lamp assembly or any electronic components unless the projector is unplugged.

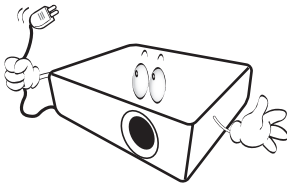

10. Do not place this product on an unstable cart, stand, or table. The product may fall, sustaining serious damage.

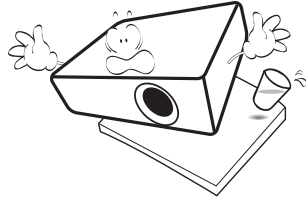

11. Do not attempt to disassemble this projector. There are dangerous high voltages inside which may cause death if you should come into contact with live parts. Under no circumstances should you ever undo or remove any other covers. Refer servicing only to suitably qualified professional service personnel.

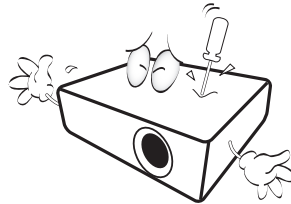

12. When the projector is under operation, you may sense some heated air and odor from its ventilation grill. It is a normal phenomenon and not a product defect.

Safety Instructions (Continued)

13. Do not place this projector in any of the following environments.

- Space that is poorly ventilated or confined. Allow at least 50 cm clearance from walls and free flow of air around the projector.
- Locations where temperatures may become excessively high, such as the inside of a car with all windows rolled up.
- Locations where excessive humidity, dust, or cigarette smoke may contaminate optical components, shortening the projector's life span and darkening the image.

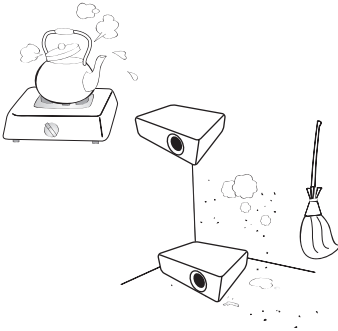

- Locations near fire alarms
- Locations with an ambient temperature above 40°C / 104°F
- Locations where the altitudes are higher than 3000 m (10000 feet).

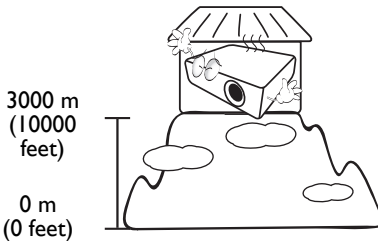

14. Do not block the ventilation holes.

- Do not place this projector on a blanket, bedding or any other soft surface.
- Do not cover this projector with a cloth or any other item.
- Do not place inflammables near the projector.

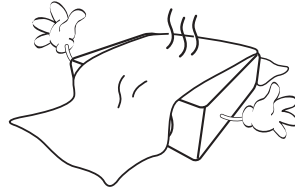

If the ventilation holes are seriously obstructed, overheating inside the projector may result in a fire.

15. Always place the projector on a level, horizontal surface during operation.

- Do not use if tilted at an angle of more than 10 degrees left to right, nor at angle of more than 15 degrees front to back. Using the projector when it is not fully horizontal may cause a malfunction of, or damage to, the lamp.

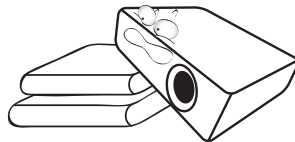

Safety Instructions (Continued)

16. Do not stand the projector on end vertically. Doing so may cause the projector to fall over, causing injury or resulting in damage to the projector.

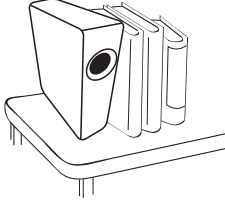

17. Do not step on the projector or place any objects upon it. Besides probable physical damage to the projector, doing so may result in accidents and possible injury.

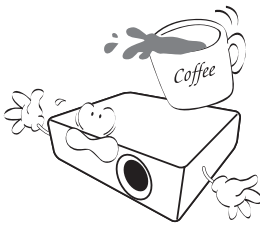

18. Do not place liquids near or on the projector. Liquids spilled into the projector may cause it to fail. If the projector does become wet, disconnect it from the power supply's wall socket and call BenQ to have the projector serviced.

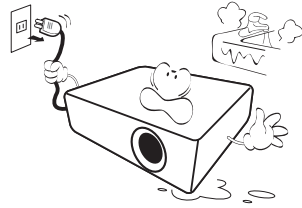

19. This product is capable of displaying inverted images for ceiling mount installation.



Use only BenQ's Ceiling Mount Kit for mounting the projector and ensure it is securely installed.

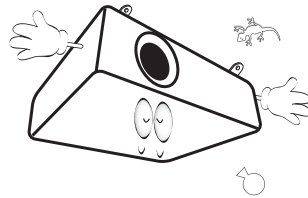

Introduction

Projector features

This model is one of the best projectors available in the world. You can enjoy the best video quality across various devices such as PC, laptop, DVD and VCR even document camera to bring all possibility to life.

The projector offers the following features.

- **2D keystone for easy horizontal and vertical keystone correction allows you to project a rectangular image from any angle**
 - **Corner Fit allows you to adjust four corners of the projected image**
 - **SmartEco™ starts your dynamic power saving**
 - **LAN display for network control and web server**
 - **USB A supports USB charging**
 - **Wall color correction allowing projection on surfaces of several predefined colors**
 - **Quick auto search speeding up the signal detecting process**
 - **3D color management allowing color adjustments to your liking**
 - **Selectable quick cooling function makes the projector cool in a shorter time**
 - **Presentation timer for better control of time during presentations**
 - **One-key auto-adjustment to display the best picture quality**
 - **Component HDTV compatibility (YPbPr)**
 - **Less than 0.5 W power consumption in standby mode**
 - **Less than 6W power consumption in network standby mode**
-  • **The apparent brightness of the projected image will vary depending on the ambient lighting conditions, selected input signal contrast/brightness settings, and is proportional to projection distance.**
- **The lamp brightness will decline over time and may vary within the lamp manufacturers specifications. This is normal and expected behavior.**

Shipping contents

Carefully unpack and verify that you have all of the items shown below. If any of these items are missing, please contact your place of purchase.

Standard accessories

☞ The supplied accessories will be suitable for your region, and may differ from those illustrated.

***The warranty card is only supplied in some specific regions. Please consult your dealer for detailed information.**

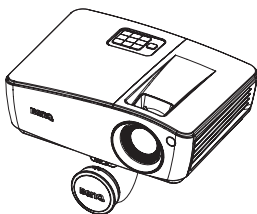

MX723 projector

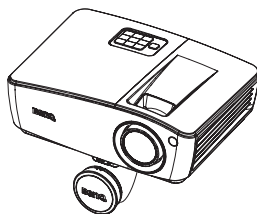

MW724 projector



Remote control or remote control without laser (depending on region) & batteries

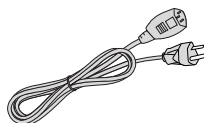

Power cord

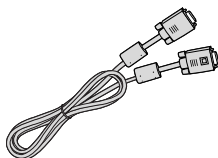

VGA cable



Quick start guide



User manual CD



Warranty card*

Optional accessories

1. Spare lamp kit
2. Ceiling mount kit
3. BenQ wireless dongle
4. carry bag
5. 3D glasses

Projector exterior view

Front/upper side

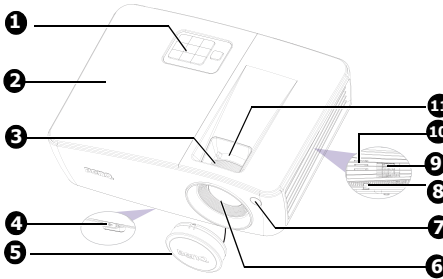

Rear/lower side

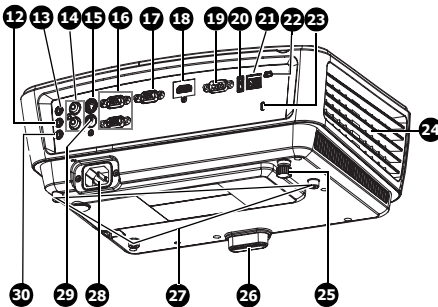

1. External control panel
(See "Projector" on page 11 for details.)
2. Lamp cover
3. Focus ring
4. Quick-release button
5. Lens cover
6. Projection lens
7. Front IR remote sensor
8. Security bar
9. Ventilation holes (intake)
10. Speaker
11. Zoom ring
12. Audio output jack
13. Audio input jack
14. Audio (L/R) input jack
15. S-Video input jack
16. RGB (PC)/Component video (YPbPr/ YCbCr) signal input jack
17. RGB signal output jack
18. HDMI input jack
19. RS-232 control port
20. USB type A/1.5A jack
21. RJ45 LAN input jack
22. USB mini-B jack
23. Kensington anti-theft lock slot
24. Ventilation holes (exhaust)
25. Rear adjuster foot
26. Quick-release adjuster foot
27. Ceiling mount holes
28. AC power cord inlet
29. Video input jack
30. Microphone input jack

Controls and functions

Projector

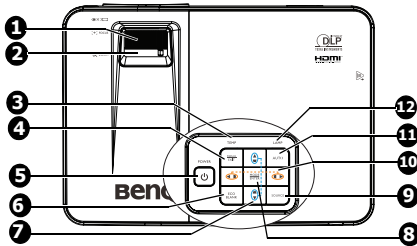

1. **Focus ring**
Adjusts the focus of the projected image.
2. **Zoom ring**
Adjusts the size of the image.
3. **TEMPERATURE indicator light**
Lights up red if the projector's temperature becomes too high. See ["Indicators" on page 72](#) for details.
4. **MENU/EXIT**
Turns on the On-Screen Display (OSD) menu. Goes back to previous OSD menu, exits and saves menu settings.
5. **Power/POWER indicator light**
Toggles the projector between standby mode and on. See ["Starting up the projector" on page 27](#) for details.
Lights up or flashes when the projector is under operation. See ["Indicators" on page 72](#) for detail.
6. **Eco Blank**
Press the **Eco Blank** button to turn off the image for a period of time with 70% lamp power saving. See ["Hiding the image" on page 44](#) for details.
7. **Keystone/Arrow keys (▲/▲Up, ▼/▼ Down)**
Displays 2D Keystone page and adjusts the vertical keystone values. See ["Correcting 2D keystone" on page 29](#) for details.
8. **MODE/ENTER**
Selects an available picture setup mode. See ["Selecting a picture mode" on page 38](#) for details.
Activates the selected On-Screen Display (OSD) menu item. See ["Using the menus" on page 32](#) for details.
9. **SOURCE**
Displays the source selection bar. See ["Switching input signal" on page 35](#) for details.
10. **Keystone/Arrow keys (◀/◀ Left, ▶/▶ Right)**
Displays 2D Keystone page and adjusts the horizontal keystone values. See ["Correcting 2D keystone" on page 29](#) for details.
When the On-Screen Display (OSD) menu is activated, the #7, and #10 keys are used as directional arrows to select the desired menu items and to make adjustments. See ["Using the menus" on page 32](#) for details.
11. **Auto**
Automatically determines the best picture timings for the displayed image. See ["Auto-adjusting the image" on page 28](#) for details.
12. **LAMP indicator light**
Indicates the status of the lamp. Lights up or flashes when the lamp has developed a problem. See ["Indicators" on page 72](#) for details.

Mounting the projector

We want you to have a pleasant experience using your BenQ projector, so we need to bring this safety matter to your attention to prevent possible damage to person and property.

If you intend to mount your projector on the ceiling or wall, we strongly recommend that you use a proper fitting BenQ projector ceiling mount kit or wall mount kit and that you ensure it is securely and safely installed.

If you use a non-BenQ brand projector mounting kit, there is a safety risk that the projector may fall from the ceiling or wall due to an improper attachment through the use of the wrong gauge or length screws.

You can purchase a BenQ projector ceiling mount or wall mount kit from the place you purchased your BenQ projector. BenQ recommends that you also purchase a separate Kensington lock compatible security cable and attach it securely to both the Kensington lock slot on the projector and the base of the mounting bracket. This will perform the secondary role of restraining the projector should its attachment to the mounting bracket become loose.

Remote control

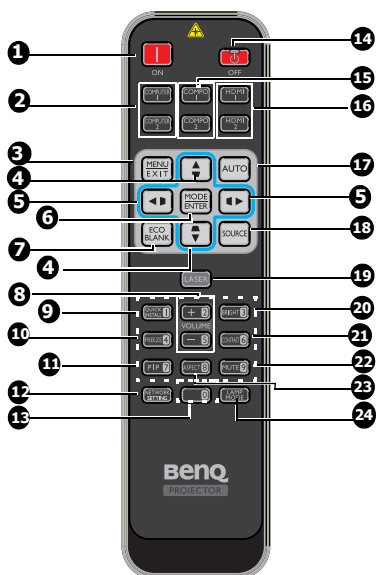

1. **ON**
Turns on the projector. See ["Starting up the projector" on page 27](#) for details.
2. **COMPUTER 1/COMPUTER 2**
Displays RGB (PC)/Component video (YPbPr/ YCbCr) signal.
3. **MENU/EXIT**
Turns on the On-Screen Display (OSD) menu. Goes back to previous OSD menu, exits and saves menu settings. See ["Using the menus" on page 32](#) for details.
4. **Keystone/Arrow keys (▼ / ▲ Up, ▲ / ▼ Down)**
Displays 2D Keystone page and adjusts the vertical keystone values. See ["Correcting 2D keystone" on page 29](#) for details.

5. **Keystone/Arrow keys (◀ / ▶ Left, ▶ / ▶ Right)**

Displays 2D Keystone page and adjusts the horizontal keystone values. See ["Correcting 2D keystone" on page 29](#) for details.

When the On-Screen Display (OSD) menu is activated, the #4, and #5 keys are used as directional arrows to select the desired menu items and to make adjustments. See ["Using the menus" on page 32](#) for details.

6. **MODE/ENTER**
Selects an available picture setup mode. See ["Selecting a picture mode" on page 38](#) for details.
Activates the selected On-Screen Display (OSD) menu item. See ["Using the menus" on page 32](#) for details.

7. **Eco Blank**
Press the **Eco Blank** button to turn off the image for a period of time with 70% lamp power saving. Press again to restore the image. See ["Hiding the image" on page 44](#) for details.

8. **VOLUME + / -**
Adjusts the microphone's sound level. See ["Adjusting the sound level" on page 45](#) for details.

9. **QUICK INSTALL**
A menu shortcut that includes Test Pattern, Projector Installation, 2D Keystone and Corner Fit.



10. **Freeze**
Freezes the projected image. See ["Freezing the image" on page 44](#) for details.

11. **PIP**
Not operational on this projector.

12. NETWORK SETTING

Displays Network Settings menu.

13. Number keys

14. OFF

Turns off the projector. See ["Shutting down the projector" on page 48](#) for details.

15. COMPO 1/COMPO 2

Not operational on this projector.

16. HDMI 1/HDMI 2

Displays HDMI signal.

17. Auto

Automatically determines the best picture timings for the displayed image. See ["Auto-adjusting the image" on page 28](#) for details.

18. SOURCE

Displays the source selection bar. See ["Switching input signal" on page 35](#) for details.

19. LASER

Emits visible laser pointer light for presentation purposes.

20. BRIGHT

Adjusts the brightness of the image.

21. CONTRAST

Adjusts the degree of difference between dark and light in the image.

22. Mute

Toggles projector audio between on and off. See ["Muting the sound" on page 45](#) for details.

23. Aspect

Selects the display aspect ratio. See ["Selecting the aspect ratio" on page 38](#) for details.

24. LAMP MODE

Displays the lamp mode selection bar (Normal/Economic/SmartEco). See ["Select the lamp saver mode" on page 46](#) for details.

Operating the laser pointer

The Laser Pointer is a presentation aid for professionals. It emits red colored light when you press it and the indicator lights up red.

The laser beam is visible. It is necessary to press and hold **LASER** for continuous output.



Do not look into the laser light window or shine the laser light beam on yourself or others. See the warning messages on the back of the remote control prior to using it.

The laser pointer is not a toy. Parents should be mindful of the dangers of laser energy and keep this remote control out of the reach of children.

*Remote control for Japan region

Avoid exposure of eyes to laser light.



Test key acts as Quick Install key.

Infra-Red (IR) remote control sensor is located on the front of the projector. The remote control must be held at an angle within 30 degrees perpendicular to the projector's IR remote control sensor to function correctly. The distance between the remote control and the sensor should not exceed 8 meters (~ 26 feet).

Make sure that there are no obstacles between the remote control and the IR sensor on the projector that might obstruct the infra-red beam.

- **Operating the projector from the front**

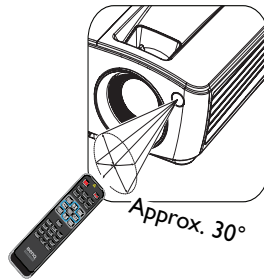

Replacing the remote control battery

1. To open the battery cover, turn the remote control over to view its back, push on the finger grip on the cover and slide it up in the direction of the arrow as illustrated. The cover will slide off.
2. Remove any existing batteries (if necessary) and install two AAA batteries observing the battery polarities as indicated in the base of the battery compartment. Positive (+) goes to positive and negative (-) goes to negative.
3. Refit the cover by aligning it with the base and sliding it back down into position. Stop when it clicks into place.

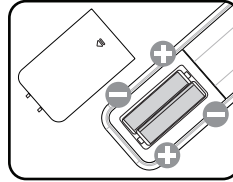
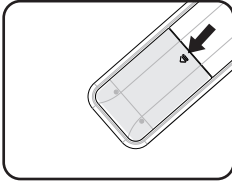

- **Avoid excessive heat and humidity.**
- **There may be battery damage if the battery is incorrectly replaced.**
- **Replace only with the same or equivalent type recommended by the battery manufacturer.**
- **Dispose of the used battery according to the battery manufacturer's instructions.**
- **Never throw a battery into a fire. There may be danger of an explosion.**
- **If the battery is dead or if you will not be using the remote control for a long time, remove the battery to prevent damage to the remote control from possible battery leakage.**

Positioning your projector

Choosing a location

Your room layout or personal preference will dictate which installation location you select. Take into consideration the size and position of your screen, the location of a suitable power outlet, as well as the location and distance between the projector and the rest of your equipment.

Your projector is designed to be installed in one of four possible installation locations:

1. Front Table

Select this location with the projector placed near the floor in front of the screen. This is the most common way to position the projector for quick setup and portability.

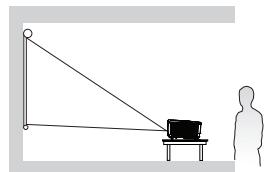

2. Front Ceiling

Select this location with the projector suspended upside-down from the ceiling in front of the screen.

Purchase the BenQ Projector Ceiling Mounting Kit from your dealer to mount your projector on the ceiling.

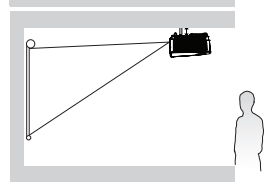

Set **Front Ceiling** in the **SYSTEM SETUP: Basic > Projector Installation** menu after you turn the projector on.

3. Rear Table

Select this location with the projector placed near the floor behind the screen.

Note that a special rear projection screen is required.

Set **Rear Table** in the **SYSTEM SETUP: Basic > Projector Installation** menu after you turn the projector on.

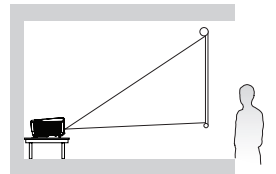

4. Rear Ceiling

Select this location with the projector suspended upside-down from the ceiling behind the screen.

Note that a special rear projection screen and the BenQ Projector Ceiling Mounting Kit are required for this installation location.

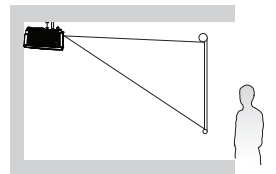

Set **Rear Ceiling** in the **SYSTEM SETUP: Basic > Projector Installation** menu after you turn the projector on.

You can also use **QUICK INSTALL** key on the remote control to select projector's location.

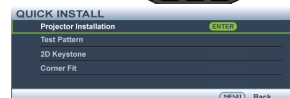

Obtaining a preferred projected image size

The distance from the projector lens to the screen, the zoom setting (if available), and the video format each factors in the projected image size.

The projector should always be placed horizontally level (like flat on a table), and positioned directly perpendicular (90° right-angle square) to the horizontal center of the screen. This prevents image distortion caused by angled projections (or projecting onto angled surfaces).

If the projector is mounted on a ceiling, it must be mounted upside-down so that it projects at a slightly downward angle.

You can see from the diagram on page 19, that this type of projection causes the bottom edge of the projected image to be vertically offset from the horizontal plane of the projector. When ceiling mounted, this refers to the top edge of the projected image.

If the projector is positioned further away from the screen, the projected image size increases, and the vertical offset also increases proportionately.

When determining the position of the screen and projector, you will need to account for both the projected image size and the vertical offset dimension, which are proportional to the projection distance.

BenQ has provided a table of screen sizes to assist you in determining the ideal location for your projector. There are two dimensions to consider, the perpendicular horizontal distance from the center of the screen (projection distance), and the vertical offset height of the projector from the horizontal edge of the screen (offset).

Projection dimensions

Refer to "Dimensions" on page 76 for the center of lens dimensions of this projector before calculating the appropriate position.

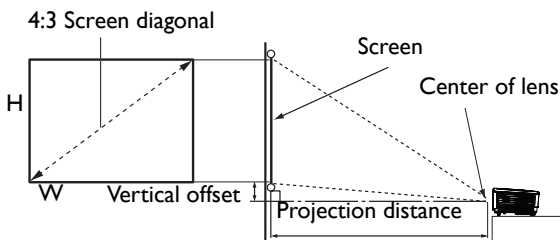

MX723

Screen size				Distance from screen (mm)			Vertical offset (mm)
Diagonal		W	H	Min length	Average	Max length	
Inch	mm	(mm)	(mm)	(max. zoom)		(min. zoom)	
40	1016	813	610	1124	1487	1850	91
60	1524	1219	914	1704	2247	2790	137
80	2032	1626	1219	2284	3007	3730	183
100	2540	2032	1524	2859	3765	4670	229
120	3048	2438	1829	3439	4525	5610	274
150	3810	3048	2286	4314	5662	7010	343
200	5080	4064	3048	5747	7554	9360	457
250	6350	5080	3810	7200	9455	11710	572
300	7620	6096	4572	8640	11350	14060	686

For example, If you are using the MX723 and a 200-inch screen, the projection distance is 7554 mm and with a vertical offset of 457 mm.

If you are using the MX723 and your measured projection distance is 5.5 m (5500 mm), the closest match in the "Distance from screen (mm)" column is 5662 mm. Looking across this row shows that a 150" (about 3810 mm) screen is required.

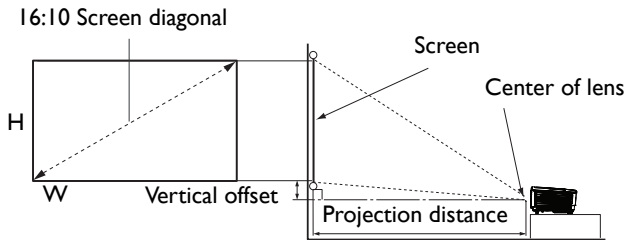

MW724

Screen size				Distance from screen (mm)			Vertical offset (mm)
Diagonal		W	H	Min length	Average	Max length	
Inch	mm	(mm)	(mm)	(max. zoom)		(min. zoom)	
40	1016	862	538	933	1107	1280	67
60	1524	1292	808	1416	1677	1937	101
80	2032	1723	1077	1900	2247	2595	135
100	2540	2154	1346	2384	2818	3252	168
120	3048	2585	1615	2867	3388	3909	202
150	3810	3231	2019	3593	4244	4895	252
200	5080	4308	2692	4802	5670	6538	337
250	6350	5385	3365	6011	7096	8181	421
300	7620	6462	4039	7220	8522	9824	505

For example, If you are using the MW724 and a 200-inch screen, the projection distance is 5670 mm and with a vertical offset of 337 mm.

If you are using the MW724 and your measured projection distance is 5.8 m (5800 mm), the closest match in the "Distance from screen (mm)" column is 5670 mm. Looking across this row shows that a 200" (about 5080 mm) screen is required.

 **All measurements are approximate and may vary from the actual sizes. BenQ recommends that if you intend to permanently install the projector, you should physically test the projection size and distance using the actual projector in situ before you permanently install it, so as to make allowance for this projector's optical characteristics. This will help you determine the exact mounting position so that it best suits your installation location.**

Connection

When connecting a signal source to the projector, be sure to:

1. Turn all equipment off before making any connections.
2. Use the correct signal cables for each source.
3. Ensure the cables are firmly inserted.

☞ • In the connections shown below, some cables may not be included with the projector (see **"Shipping contents"** on page 8). They are commercially available from electronics stores.

- For detailed connection methods, see pages 22-26.

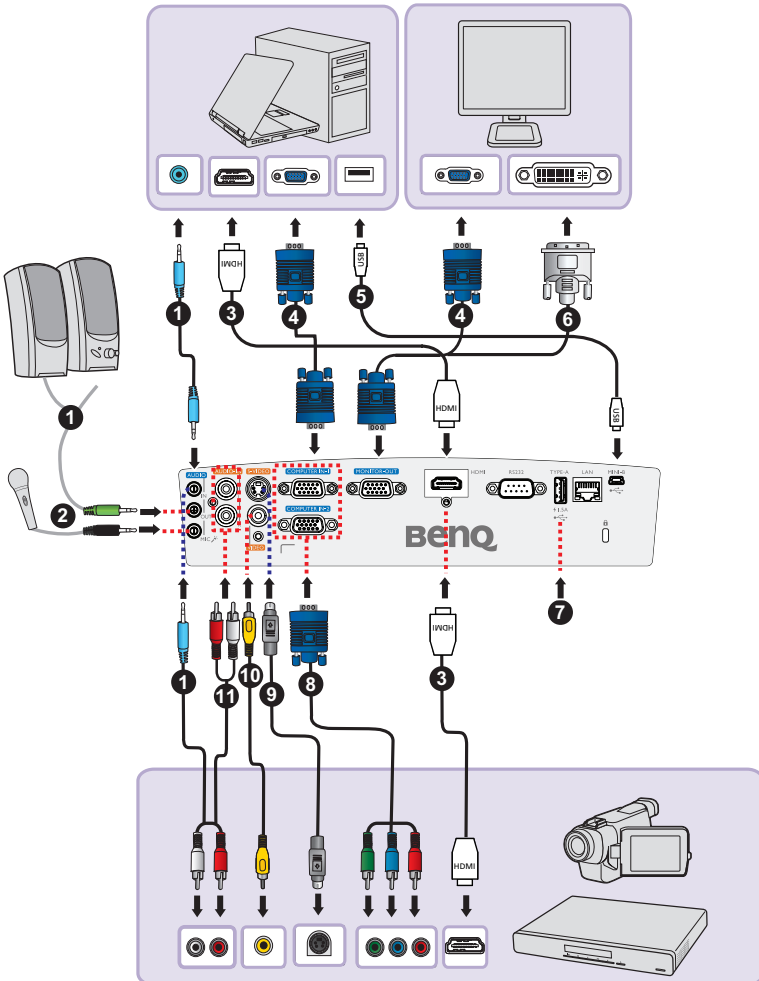

1. Audio cable	7. USB port for power charging
2. Microphone 3.5 mini jack cable	8. Component Video to VGA (DSub) adapter cable
3. HDMI cable	9. S-Video cable
4. VGA cable	10. Video cable
5. USB cable (mini-B to type A)	11. Audio L/R cable
6. VGA to DVI-A cable	

Connecting a computer or monitor

Connecting a computer

The projector can connect to both IBM® compatibles and Macintosh® computers. A Mac adapter is needed if you are connecting legacy version Macintosh computers.

To connect the projector to a notebook or desktop computer (using VGA):

1. Take the supplied VGA cable and connect one end to the D-Sub output socket of the computer.
2. Connect the other end of the VGA cable to the **COMPUTER IN-1** or **COMPUTER IN-2** signal input jack on the projector.
3. If you wish to make use of the projector speaker(s) in your presentations, take a suitable audio cable and connect one end of the cable to the audio output jack of the computer, and the other end to the **AUDIO IN** jack of the projector. When you connect audio output signal from a computer, please balance out the volume control bar to obtain an optimal sound effects.
4. If you wish, you can use another suitable audio cable and connect one end of the cable to the **AUDIO OUT** jack of the projector, and the other end to your external speakers (not supplied).

Once connected, the audio can be controlled by the projector On-Screen Display (OSD) menus. See "[Audio Settings](#)" on page 61 for details.

The built-in speaker will be muted when the **AUDIO OUT** jack is connected.

To connect the projector to a notebook or desktop computer (using LAN):

1. Take a RJ45 cable and connect one end to the **LAN** input jack of the projector and the other end to the RJ45 port.
2. Make sure that your computer is also connected to an internet cable. Please use Q Presenter program to connect network display and transfers the desktop contents of the host PC via local network connection.

 • **Do not use the RJ45 cable to connect the projector to your computer. Because this connection needs an IP router.**

- Transmission speed and image quality will vary according to the bandwidth of local area network and the status of network usage.

To connect the projector to a notebook or desktop computer (using HDMI):

1. Take a HDMI cable and connect one end to the HDMI jack of the computer.
2. Connect the other end of the cable to the **HDMI** jack on the projector.

-  • Many notebooks do not turn on their external video ports when connected to a projector. Usually a key combo like **FN + F3** or **CRT/LCD** key turns the external display on/off. Locate a function key labeled **CRT/LCD** or a function key with a monitor symbol on the notebook. Press **FN** and the labeled function key simultaneously. Refer to your notebook's documentation to find your notebook's key combination.

Connecting a monitor

If you want to view your presentation close-up on a monitor as well as on the screen, you can connect the **MONITOR OUT** signal output jack on the projector to an external monitor following the instructions below:





To connect the projector to a monitor:

1. Connect the projector to a computer as described in "[Connecting a computer](#)" on page 22.
2. Take a suitable VGA cable (only one supplied) and connect one end of the cable to the D-Sub input jack of the video monitor.
Or if your monitor is equipped with a DVI input jack, take a VGA to DVI-A cable and connect the DVI end of the cable to the DVI input jack of the video monitor.
3. Connect the other end of the cable to the **MONITOR OUT** jack on the projector.

-  • The output signal for **MONITOR OUT** jack only works when the input signal comes from **COMPUTER IN-1** or **COMPUTER IN-2** jack. When the projector is powered on, the output signal from **MONITOR OUT** jack varies depending on the input signal from **COMPUTER IN-1** or **COMPUTER IN-2** jack.
- If you wish to use this connection method when the projector is in standby mode, make sure the **MONITOR OUT** function is turned on in the **SYSTEM SETUP: Advanced > Standby Settings** menu. See "[Standby Settings](#)" on page 63 for details.

Connecting Video source devices

You need only connect the projector to a Video source device using just one of the above connecting methods, however each provides a different level of video quality. The method you choose will most likely depend upon the availability of matching terminals on both the projector and the Video source device as described below:

Terminal name	Terminal appearance	Reference	Picture quality
HDMI	HDMI 	"Connecting an HDMI source device" on page 24	Best
Component Video	COMPUTER IN-1/ COMPUTER IN-2 	"Connecting a Component Video source device" on page 25	Better
S-Video	S-VIDEO 	"Connecting an S-Video/composite source device" on page 26	Good
Video	VIDEO 		Normal

Connecting an HDMI source device

The projector provides an HDMI input jack that allows you to connect it to an HDMI source device like a DVD player, a DTV tuner, a display or a notebook computer.

HDMI (High-Definition Multimedia Interface) supports uncompressed video data transmission between compatible devices like DTV tuners, DVD players and displays over a single cable. It provides pure digital viewing and listening experience.

Examine your Video source device to determine if it has a set of unused HDMI output jacks available:

- **If so, you can continue with this procedure.**
- **If not, you will need to reassess which method you can use to connect to the device.**

To connect the projector to an HDMI source device:

1. Take an HDMI cable and connect one end to the HDMI output jack of the HDMI source device.
2. Connect the other end of the cable to the **HDMI** signal input jack on the projector. Once connected, the audio can be controlled by the projector On-Screen Display (OSD) menus. See "[Audio Settings](#)" on page 61 for details.

-  • **If the selected video image is not displayed after the projector is turned on and the correct video source has been selected, check that the Video**

source device is turned on and operating correctly. Also check that the signal cables have been connected correctly.

- In the unlikely event that you connect the projector to a DVD player via the projector's HDMI input and the projected picture displays wrong colors, please change the color space to YUV. See "[Changing Color Space](#)" on page 36 for details.

Connecting a Component Video source device

Examine your Video source device to determine if it has a set of unused Component Video output jacks available:

- If so, you can continue with this procedure.
- If not, you will need to reassess which method you can use to connect to the device.

To connect the projector to a Component Video source device:

1. Take a Component Video to VGA (D-Sub) adaptor cable and connect the end with 3 RCA type connectors to the Component Video output jacks of the Video source device. Match the color of the plugs to the color of the jacks; green to green, blue to blue, and red to red.
2. Connect the other end of the Component Video to VGA (D-Sub) adaptor cable (with a D-Sub type connector) to the **COMPUTER IN-1** or **COMPUTER IN-2** jack on the projector.
3. If you wish to make use of the projector speaker(s) in your presentations, take a suitable audio cable and connect one end of the cable to the audio output jack of the device, and the other end to the **AUDIO (L/R)** jack of the projector.
4. If you wish, you can use another suitable audio cable and connect one end of the cable to the **AUDIO OUT** jack of the projector, and the other end to your external speakers (not supplied).

Once connected, the audio can be controlled by the projector On-Screen Display (OSD) menus. See "[Audio Settings](#)" on page 61 for details.

The built-in speaker will be muted when the **AUDIO OUT** jack is connected.

 If the selected video image is not displayed after the projector is turned on and the correct video source has been selected, check that the Video source device is turned on and operating correctly. Also check that the signal cables have been connected correctly.

Connecting an S-Video/composite source device

Examine your Video source device to determine if it has an unused S-Video/composite output jack available:

- **If it has both jacks, use the S-Video output jack for connection as the S-Video terminal provides better picture quality than the Video terminal.**
- **If it has either of the output jacks, you can also continue with this procedure.**
- **If not, you will need to reassess which method you can use to connect to the device.**

To connect the projector to an S-Video/Video source device:

1. Take an S-Video/Video cable and connect one end to the S-Video/Video output jack of the Video source device.
2. Connect the other end of the S-Video/Video cable to the **S-VIDEO/VIDEO** jack on the projector.
3. If you wish to make use of the projector speaker(s) in your presentations, take a suitable audio cable and connect one end of the cable to the audio output jack of the device, and the other end to the **AUDIO (L/R)** jack of the projector.
4. If you wish, you can use another suitable audio cable and connect one end of the cable to the **AUDIO OUT** jack of the projector, and the other end to your external speakers (not supplied).

Once connected, the audio can be controlled by the projector On-Screen Display (OSD) menus. See "[Audio Settings](#)" on page 61 for details.

The built-in speaker will be muted when the **AUDIO OUT** jack is connected.



- **If the selected video image is not displayed after the projector is turned on and the correct video source has been selected, check that the Video source device is turned on and operating correctly. Also check that the signal cables have been connected correctly.**

Operation

Starting up the projector

1. Plug the power cord into the projector and into a power outlet. Check that the **POWER indicator light** on the projector lights orange after power has been applied.

 • **Please use the original accessories (e.g. power cable) only with the device to avoid possible dangers such as electric shock and fire.**

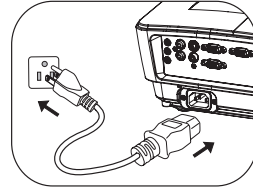

- If **Direct Power On** function is activated in the **SYSTEM SETUP: Basic > Operation Settings** menu, the projector will turn on automatically after the power cord has been connected and power has been applied. See "**Direct Power On**" on page 60 for details.
- If **Signal Power On** function is activated in the **SYSTEM SETUP: Basic > Operation Settings** menu, the projector will turn on automatically when **VGA** signal is detected. See "**Signal Power On**" on page 60 for details.

2. Make sure the lens cover is open. If it is closed, it could become deformed due to the heat produced by the projection lamp.

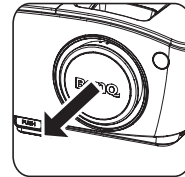

3. Press  **Power** on the projector or **ON** on the remote control to start the projector. The **POWER indicator light** flashes and stays green when the projector is on.

The start up procedure takes about 10-20 seconds. In the later stage of start up, a startup logo is projected.

(If necessary) Use the focus ring to adjust the image clearness.

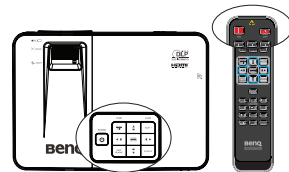

 **If the projector is still hot from previous activity, it will run the cooling fan for approximately 90 seconds before energizing the lamp.**

- If the projector is activated for the first time, select your OSD language following the on-screen instructions.
- If you are prompted for a password, press the arrow keys to enter a six digit password. See ["Utilizing the password function" on page 33](#) for details.
- Switch all of the connected equipment on.
- The projector will start to search for input signals. The current input signal being scanned displays in the screen. If the projector doesn't detect a valid signal, the message **'No Signal'** will continue displaying until an input signal is found. You can also press **SOURCE** on the projector or remote control to select your desired input signal. See ["Switching input signal" on page 35](#) for details.



- ☞ If no signal is detected for 3 minutes, the projector automatically enters **ECO BLANK** mode.

Adjusting the projected image

Adjusting the projection angle

The projector is equipped with 1 quick-release adjuster foot and 1 rear adjuster foot. These adjusters change the image height and projection angle. To adjust the projector:

- Press the quick-release button and lift the front of the projector. Once the image is positioned where you want it, release the quick-release button to lock the foot in position.
- Screw the rear adjuster foot to fine tune the horizontal angle.

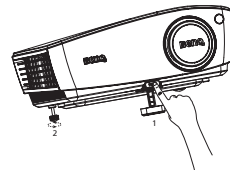

To retract the foot, hold up the projector while pressing the quick-release button, then slowly lower the projector. Screw the rear adjuster foot in a reverse direction.

If the projector is not placed on a flat surface or the screen and the projector are not perpendicular to each other, the projected image becomes trapezoidal. To correct this situation, see ["Correcting 2D keystone" on page 29](#) for details.

- ⚠ **Do not look into the lens while the lamp is on. The strong light from the lamp may cause damage to your eyes.**
- Be careful when you press the adjuster button as it is close to the exhaust vent where hot air comes from.**

Auto-adjusting the image

In some cases, you may need to optimize the picture quality. To do this, press **AUTO** on the projector or remote control. Within 5 seconds, the built-in Intelligent Auto Adjust function will re-adjust the values of Frequency and Clock to provide the best picture quality.

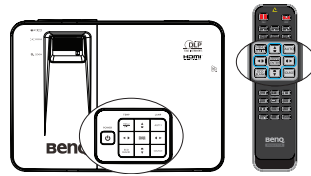

- The screen will display "Auto adjusting" while **AUTO** is functioning.

- This function is only available when **PC signal (analog RGB)** is selected.

Correcting 2D keystone

2D Keystone function enables a wider projector installation area compared to conventional projectors with limited positioning in front of the screen.

To correct this, you will need to manually correct it following one of these steps.

- Using the projector or remote control

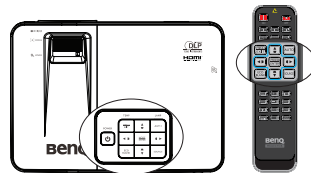

Press **▲/▼/◀/▶** to display the **Keystone** page. Press **▲/▼** to adjust vertical values from -30 to 30. Press **◀/▶** to adjust horizontal values from -25 to 25.

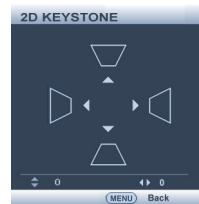

- Using the OSD menu
 1. Press **Menu/Exit** and select the **DISPLAY** menu.
 2. Press **▼** to select **Keystone** and press **Mode/Enter**.
 3. Press **▲/▼/◀/▶** to adjust the keystone values.



- Using the **QUICK INSTALL** key
 1. Press **QUICK INSTALL** on the remote control.
 2. Press **▼** to select **Keystone** and press **Mode/Enter**.
 3. Press **▲/▼/◀/▶** to adjust the keystone values.

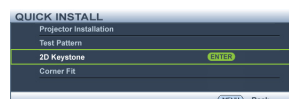

Adjusting corner fit

Manually adjust four corners of the image by setting the horizontal and vertical values.

- Using the OSD menu

1. Select **Corner Fit** in the **DISPLAY** menu and press **Mode/Enter**.

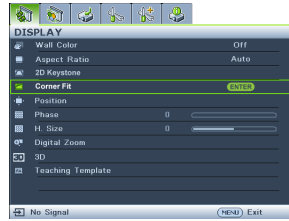

2. Press **▲/▼/◀/▶** to select one of the four corners and press **Mode/Enter**.

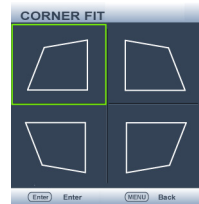

3. Press **▲/▼** to adjust vertical values from 0 to 60.
 4. Press **◀/▶** to adjust horizontal values from 0 to 60.

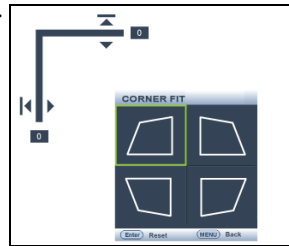

- Using the **QUICK INSTALL** key

1. Press **QUICK INSTALL** on the remote control.



2. Press **▼** to select **Corner Fit** and press **Mode/Enter**.

3. Follow the steps 2~4 in the above section.

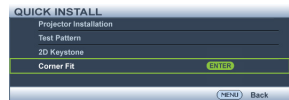

Fine-tuning the image size and clarity

1. Adjust the projected image to the size that you need using the zoom slide lever.

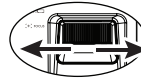

2. Then sharpen the image by using the focus ring.

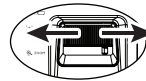
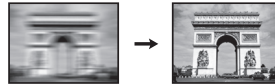

Using the menus

The projector is equipped with On-Screen Display (OSD) menus for making various adjustments and settings.

Below is the overview of the OSD menu.



The following example describes how to set the OSD menu.

1. Press **Menu/Exit** on the projector or remote control to turn the OSD menu on.
3. Press **▼** to select **Background Color** and press **◀/▶** to select a background color.

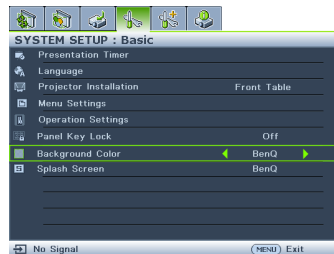

2. Use **◀/▶** to select the **SYSTEM SETUP: Basic** menu.
4. Press **Menu/Exit** twice* on the projector or remote control to leave and save the settings.
*The first press leads you back to the main menu and the second press closes the OSD menu.



Securing the projector

Using a security cable lock

The projector has to be installed in a safe place to prevent theft. Otherwise, purchase a lock, such as the Kensington lock, to secure the projector. You can locate a Kensington lock slot on the rear side of the projector. See item 23 on page 10 for details.

A Kensington security cable lock is usually a combination of key(s) and the lock. Refer to the lock's documentation for finding out how to use it.

Utilizing the password function

For security purposes and to help prevent unauthorized use, the projector includes an option for setting up password security. The password can be set through the On-Screen Display (OSD) menu.

 **WARNING: You will be inconvenienced if you activate the power-on lock functionality and subsequently forget the password. Print out this manual (if necessary) and write the password you used in this manual, and keep the manual in a safe place for later recall.**

Setting a password

 **Once a password has been set, the projector cannot be used unless the correct password is entered every time the projector is started.**

1. Open the OSD menu and go to the **SYSTEM SETUP: Advanced > Security Settings** menu. Press **Mode/Enter**.
2. Press **▼** to select **Change Security Settings** and press **Mode/Enter**.
3. Enter the new or current password. As

pictured to the right, the four arrow keys (**▲**, **▶**, **▼**, **◀**) respectively represent 4 digits (1, 2, 3, 4). According to the password you desire to set, press the arrow keys to enter six digits for the password.

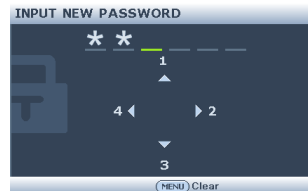

If the function is used for the first time, enter the default password (1, 1, 1, 1, 1, 1) of the projector by pressing the arrow key **▲** six times.

4. Confirm the new password by re-entering the new password. Once the password is set, the OSD menu returns to the **Security Settings** page.

 **IMPORTANT: The digits being input will display as asterisks on-screen. Write your selected password down here in this manual in advance or right after the password is entered so that it is available to you should you ever forget it.**

Password: _____

Keep this manual in a safe place.

5. Press **▼** to select **Power On Lock** and select **On** by pressing **◀/▶**.

- To leave the OSD menu, press **Menu/Exit**.

If you forget the password

If the password function is activated, you will be asked to enter the six-digit password every time you turn on the projector. If you enter the wrong password, the password error message as pictured to the right displays lasting for three seconds, and the message 'INPUT PASSWORD' follows. You can retry by entering another six-digit password, or if you did not record the password in this manual, and you absolutely do not remember it, you can use the password recall procedure. See "[Entering the password recall procedure](#)" on page 34 for details.

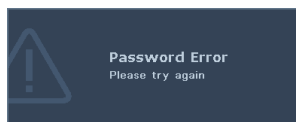

If you enter an incorrect password 5 times in succession, the projector will automatically shut down in a short time.

Entering the password recall procedure

- Press and hold **AUTO** on the projector or remote control for 3 seconds. The projector will display a coded number on the screen.
- Write down the number and turn off your projector.
- Seek help from the local BenQ service center to decode the number. You may be required to provide proof of purchase documentation to verify that you are an authorized user of the projector.

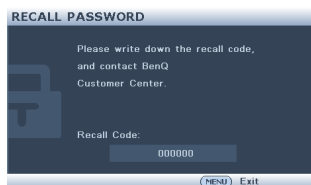

Changing the password

- Open the OSD menu and go to the **SYSTEM SETUP: Advanced > Security Settings**.
- Select **Change Password** and press **Mode/Enter**. The message 'INPUT CURRENT PASSWORD' displays.
- Enter the old password.
 - If the password is correct, another message 'INPUT NEW PASSWORD' displays.
 - If the password is incorrect, the password error message displays lasting for three seconds, and the message 'INPUT CURRENT PASSWORD' displays for your retry. You can press **Menu/Exit** to cancel the change or try another password.
- Enter a new password.



IMPORTANT: The digits being input will display as asterisks on-screen. Write your selected password down here in this manual in advance or right after the password is entered so that it is available to you should you ever forget it.

Password: _____

Keep this manual in a safe place.

5. Confirm the new password by re-entering the new password.
6. You have successfully assigned a new password to the projector. Remember to enter the new password next time the projector is started.
7. To leave the OSD menu, press **Menu/Exit**.

Disabling the password function

To disable password protection, go back to the **SYSTEM SETUP: Advanced > Security Settings > Change Security Settings** menu after opening the OSD menu system and press **Mode/Enter**. The message **'INPUT PASSWORD'** displays. Enter the current password.

- If the password is correct, the OSD menu returns to the **Security Settings** page. Select **Power On Lock** and select **Off** by pressing **◀ / ▶**. You will not have to enter the password next time you turn on the projector.
- If the password is incorrect, the password error message displays lasting for three seconds, and the message **'INPUT PASSWORD'** displays for your retry. You can press **Menu/Exit** to cancel the change or try another password.

 **Though the password function is disabled, you need to keep the old password in hand should you ever need to re-activate the password function by entering the old password.**

Switching input signal

The projector can be connected to multiple devices at the same time. However, it can only display one full screen at a time. When starting up, the projector automatically searches for the available signals.

Be sure the **Quick Auto Search** function in the **SOURCE** menu is **On** (which is the default of this projector) if you want the projector to automatically search for the signals.

You can also manually cycle through the available input signals.

1. Press **SOURCE** on the projector or remote control. A source selection bar displays.

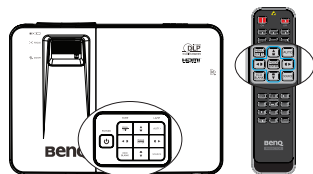

2. Press **▲ / ▼** until your desired signal is selected and press **Mode/Enter**. Once detected, the selected source information will display on the screen for seconds. If there is multiple equipment connected to the projector, repeat steps 1-2 to search for another signal.

 **The brightness level of the projected image will change accordingly when you switch between different input signals. Data (graphic) "PC" presentations using mostly**

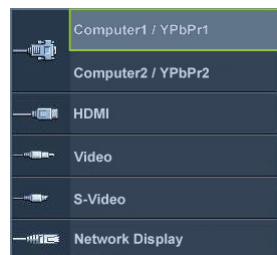

static images are generally brighter than "Video" using mostly moving images (movies).

- The input signal type effects the options available for the Picture Mode. See "[Selecting a picture mode](#)" on page 38 for details.
- The native display resolution of MX723 is in a 4:3 aspect ratio while the native display resolution of MW724 is in a 16:10 aspect ratio. For best display picture results, you should select and use an input signal which outputs at this resolution. Any other resolutions will be scaled by the projector depending upon the 'aspect ratio' setting, which may cause some image distortion or loss of picture clarity. See "[Selecting the aspect ratio](#)" on page 37 for details.

Changing Color Space

In the unlikely event that you connect the projector to a DVD player via the projector's HDMI input and the projected picture displays wrong colors, please change the color space to YUV.

1. Press **Menu/Exit** and then press ◀/▶ until the **SOURCE** menu is selected.
2. Press ▼ to select **Color Space Conversion** and press ◀/▶ to select a suitable color space.

 This function is only available when the HDMI input port is in use.

Magnifying and searching for details

If you need to find the details on the projected picture, magnify the picture. Use the direction arrow keys for navigating the picture.

- Using the OSD menu
 1. Press **Menu/Exit** and then press ◀/▶ until the **DISPLAY** menu is selected.
 2. Press ▼ to select **Digital Zoom** and press **Mode/Enter**. The Zoom bar displays.
 3. Press ▲ on the projector repeatedly to magnify the picture to a desired size.
 4. To navigate the picture, press **Mode/Enter** to switch to the panning mode and press the directional arrows (▲, ▼, ◀, ▶) to navigate the picture.
 5. To reduce size of the picture, press **Mode/Enter** to switch back to the zoom in/out functionality, and press **AUTO** to restore the picture to its original size. You can also press ▼ repeatedly until it is restored to the original size.

 The picture can only be navigated after the picture is magnified. You can further magnify the picture while searching for details.

Selecting the aspect ratio

The 'aspect ratio' is the ratio of the image width to the image height.

With the advent of digital signal processing, digital display devices like this projector can dynamically stretch and scale the image output to a different aspect than that of the image input signal.

To change the projected image ratio (no matter what aspect the source is):

- Using the remote control
 1. Press **Aspect** to show the current setting.
 2. Press **Aspect** repeatedly to select an aspect ratio to suit the format of the video signal and your display requirements.
- Using the OSD menu
 1. Press **Menu/Exit** and then press **◀ / ▶** until the **DISPLAY** menu is selected.
 2. Press **▼** to select **Aspect Ratio**.
 3. Press **◀ / ▶** to select an aspect ratio to suit the format of the video signal and your display requirements.



About the aspect ratio

 In the pictures below, the black portions are inactive areas and the white portions are active areas. OSD menus can be displayed on those unused black areas.

1. **Auto:** Scales an image proportionally to fit the projector's native resolution in its horizontal or vertical width. This is suitable for the incoming image which is neither in 4:3 nor 16:9 and you want to make most use of the screen without altering the image's aspect ratio.

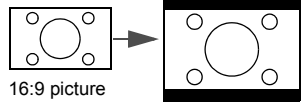
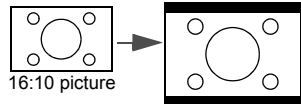

2. **Real:** The image is projected as its original resolution, and resized to fit within the display area. For input signals with lower resolutions, the projected image will display smaller than if resized to full screen. You could adjust the zoom setting or move the projector towards the screen to increase the image size if necessary. You may also need to refocus the projector after making these adjustments.

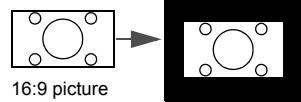
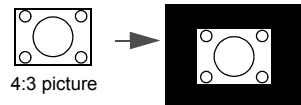

3. **4:3:** Scales an image so that it is displayed in the center of the screen with a 4:3 aspect ratio. This is most suitable for 4:3 images like computer

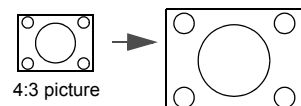

monitors, standard definition TV and 4:3 aspect DVD movies, as it displays them without aspect alteration.

4. **16:9**: Scales an image so that it is displayed in the center of the screen with a 16:9 aspect ratio. This is most suitable for images which are already in a 16:9 aspect, like high definition TV, as it displays them without aspect alteration.
5. **16:10**: Scales an image so that it is displayed in the center of the screen with a 16:10 aspect ratio. This is most suitable for images which are already in a 16:10 aspect, like high definition TV, as it displays them without aspect alteration.

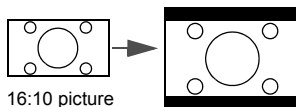
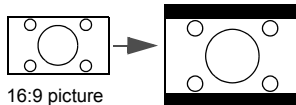

Optimizing the image

Selecting a picture mode

The projector is preset with several predefined picture modes so that you can choose one to suit your operating environment and input signal picture type.

To select an operation mode that suits your need, you can follow one of the following steps.

- Press **Mode/Enter** on the remote control or projector repeatedly until your desired mode is selected.
- Go to the **PICTURE > Picture Mode** menu and press **◀/▶** to select a desired mode.

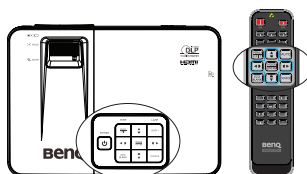

The picture modes are listed below.

1. **Dynamic** mode: Maximizes the brightness of the projected image. This mode is suitable for environments where extra-high brightness is required, such as using the projector in well lit rooms.
2. **Presentation** mode (Default): Is designed for presentations. The brightness is emphasized in this mode.
3. **sRGB** mode: Maximizes the purity of RGB colors to provide true-to-life images regardless of brightness setting. It is most suitable for viewing photos taken with an sRGB compatible and properly calibrated camera, and for viewing PC graphic and drawing applications such as AutoCAD.
4. **Cinema** mode: Is appropriate for playing colorful movies, video clips from digital cameras or DVs through the PC input for best viewing in a blackened (little light) environment.
5. **User 1/User 2** mode: Recalls the settings customized based on the current available picture modes. See "[Setting the User 1/User 2 mode](#)" on page 38 for details.

Setting the User 1/User 2 mode

There are two user-definable modes if the current available picture modes are not suitable for your need. You can use one of the picture modes (except the **User 1 / User 2**) as a starting point and customize the settings.

1. Press **Menu/Exit** to open the On-Screen Display (OSD) menu.
2. Go to the **PICTURE > Picture Mode** menu.
3. Press **◀/▶** to select **User 1** to **User 2**.
4. Press **▼** to select **Reference Mode**.

 **This function is only available when User 1 or User 2 mode is selected up in the Picture Mode sub-menu item.**

5. Press **◀/▶** to select a picture mode that is closest to your need.
6. Press **▼** to select a sub-menu item to be changed and adjust the value with **◀/▶**. See "[Fine-tuning the image quality in user modes](#)" below for details.
7. The settings will be saved when selecting.

Using Wall Color

In the situation where you are projecting onto a colored surface such as a painted wall which may not be white, the **Wall Color** feature can help correct the projected picture's color to prevent possible color difference between the source and projected pictures.

To use this function, go to the **DISPLAY > Wall Color** menu and press **◀/▶** to select a color which is the closest to the color of the projection surface. There are several precalibrated colors to choose from: Light Yellow, Pink, Light Green, Blue, and Blackboard.

Fine-tuning the image quality in user modes

According to the detected signal type, there are some user-definable functions available when **User 1** or **User 2** mode is selected. Based on your needs, you can make adjustments to these functions by selecting them and pressing **◀/▶** on the projector or remote control.

Adjusting Brightness

The higher the value, the brighter the image. And the lower the setting, the darker the image. Adjust this control so the black areas of the image appear just as black and that detail in the dark areas is visible.



Adjusting Contrast

The higher the value, the greater the contrast. Use this to set the peak white level after you have previously adjusted the **Brightness** setting to suit your selected input and viewing environment.



You can also adjust **Brightness** or **Contrast** by using **BRIGHT** or **CONTRAST** key on the remote control.



Adjusting Color

Lower setting produces less saturated colors. If the setting is too high, colors on the image will be overpowering, which makes the image unrealistic.

Adjusting Tint

The higher the value, the more reddish the picture becomes. The lower the value, the more greenish the picture becomes.

Adjusting Sharpness

The higher the value, the sharper the picture becomes. The lower the value, the softer the picture becomes.

Adjusting Brilliant Color

This feature utilizes a new color-processing algorithm and system level enhancements to enable higher brightness while providing truer, more vibrant colors in picture. It enables a greater than 50% brightness increase in mid-tone images, which are common in video and natural scenes, so the projector reproduces images in realistic and true colors. If you prefer images with that quality, select **On**. If you don't need it, select **Off**.

On is the default and recommended selection for this projector. When **Off** is selected, the **Color Temperature** function is not available.

Selecting a Color Temperature

The options available for color temperature* settings vary according to the signal type selected.

1. **Cool:** Makes images appear bluish white.
2. **Normal:** Maintains normal colorings for white.
3. **Warm:** Makes images appear reddish white.

*About color temperatures:

There are many different shades that are considered to be "white" for various purposes. One of the common methods of representing white color is known as the "color temperature". A white color with a low color temperature appears to be reddish white. A white color with a high color temperature appears to have more blue in it.

Setting a preferred color temperature

To set a preferred color temperature:

1. Select **Color Temperature** and select **Warm, Normal** or **Cool** by pressing **◀/▶** on the projector or remote control.
2. Press **▼** to select **Color Temperature Fine Tuning** and press **MODE/ENTER**. The Color Temperature Fine Tuning page displays.
3. Press **▲/▼** to select the item you want to change and adjust the values by pressing **◀/▶**.
 - **R Gain/G Gain/B Gain:** Adjusts the contrast levels of Red, Green, and Blue.
 - **R Offset/G Offset/B Offset:** Adjusts the brightness levels of Red, Green, and Blue.
4. Press **MENU/EXIT** to exit and save the settings.

3D Color Management

In most installation situations, color management will not be necessary, such as in classroom, meeting room, or lounge room situations where lights remain on, or where building external windows allow daylight into the room.

Only in permanent installations with controlled lighting levels such as boardrooms, lecture theaters, or home theaters, should color management be considered. Color management provides fine color control adjacent to allow for more accurate color reproduction, should you require it.

Proper color management can only be achieved under controlled and reproducible viewing conditions. You will need to use a colorimeter (color light meter), and provide a set of suitable source images to measure color reproduction. These tools are not provided with the projector; however, your projector supplier should be able to provide you with suitable guidance, or even an experienced professional installer.

The Color Management provides six sets (RGBCMY) of colors to be adjusted. When you select each color, you can independently adjust its range and saturation according to your preference.

If you have purchased a test disc which contains various color test patterns and can be used to test the color presentation on monitors, TVs, projectors, etc. You can project any image from the disc on the screen and enter the **3D Color Management** menu to make adjustments.

To adjust the settings:

1. Go to the **PICTURE** menu and select **3D Color Management**.
 2. Press **Mode/Enter** and the **3D Color Management** page displays.
 3. Select **Primary Color** and press ◀/▶ to select a color from among Red, Yellow, Green, Cyan, Blue, or Magenta.
 4. Press ▼ to select **Hue** and press ◀/▶ to select its range. Increase in the range will include colors consisted of more proportions of its two adjacent colors. Please refer to the illustration to the right for how the colors relate to each other. For example, if you select Red and set its range at 0, only pure red in the projected picture will be selected. Increasing its range will include red close to yellow and red close to magenta.
 5. Press ▼ to select **Saturation** and adjust its values to your preference by pressing ◀/▶. Every adjustment made will reflect to the image immediately. For example, if you select Red and set its value at 0, only the saturation of pure red will be affected.
- ☞ **Saturation** is the amount of that color in a video picture. Lower settings produce less saturated colors; a setting of “0” removes that color from the image entirely. If the saturation is too high, that color will be overpowering and unrealistic.
6. Press ▼ to select **Gain** and adjust its values to your preference by pressing ◀/▶. The contrast level of the primary color you select will be affected. Every adjustment made will reflect to the image immediately.
 7. Repeat steps 3 to 6 for other color adjustments.
 8. Make sure you have made all of the desired adjustments.

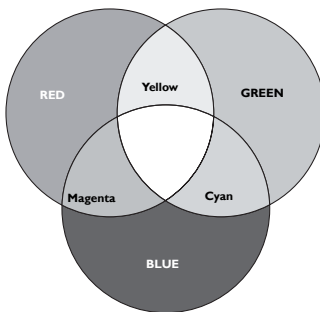

9. Press **Menu/Exit** to exit and save the settings.

Resetting current or all picture modes

1. Go to the **PICTURE** menu and select **Reset Picture Settings**.
2. Press **MODE/ENTER** and press **▲/▼** to select **Current** or **All**.
 - **Current**: returns current picture mode to the factory preset settings.
 - **All**: returns all settings, except **User 1/User 2** in the **PICTURE** menu to the factory preset settings.

Setting the presentation timer

The presentation timer can indicate the presentation time on the screen to help you achieve better time management when giving presentations. Follow these steps to utilize this function:

1. Go to the **SYSTEM SETUP: Basic > Presentation Timer** menu and press **Mode/Enter** to display the **Presentation Timer** page.
2. Select **Timer Period** and decide the timer period by pressing ◀/▶. The length of time can be set from 1 to 5 minutes in 1-minute increments and 5 to 240 minutes in 5-minute increments.
3. Press ▼ to select **Timer Display** and choose if you want the timer to show up on the screen by pressing ◀/▶.

Selection	Description
Always	Displays the timer on screen throughout the presentation time.
1 Min/2 Min/3 Min	Displays the timer on screen in the last 1/2/3 minute(s).
Never	Hides the timer throughout the presentation time.

4. Press ▼ to select **Timer Position** and set the timer position by pressing ◀/▶.
Top-Left → Bottom-Left → Top-Right → Bottom-Right
5. Press ▼ to select **Timer Counting Direction** and select your desired counting direction by pressing ◀/▶.

Selection	Description
Count Up	Increases from 0 to the preset time.
Count Down	Decrease from the preset time to 0.

6. Press ▼ to select **Sound reminder** and decide if you want to activate sound reminder by pressing ◀/▶. If you select **On**, a double beep sound will be heard at the last 30 seconds of counting down/up, and a triple beep sound will be produced when the timer is up.
7. To activate the presentation timer, press ▼ and press ◀/▶ to select **On** and press **Mode/Enter**.
8. A confirmation message displays. Select **Yes** and press **Mode/Enter** to confirm. You will see the message “**Timer is On**” displaying on the screen. The timer starts counting at the time the timer is on.

To cancel the timer, perform the following steps:

1. Go to the **SYSTEM SETUP: Basic > Presentation Timer** menu and press select ▼ to select **Off**. Press **Mode/Enter**. A confirmation message displays.
2. Select **Yes** and press **Mode/Enter** to confirm. You will see the message “**Timer is Off!**” displaying on the screen.

Hiding the image

In order to draw the audience's full attention to the presenter, you can use **ECO BLANK** to hide the screen image. Press any key on the projector or remote control to restore the image. Eco Blank wording appears at the screen while the image is hidden. When this function is activated with an audio input connected, the audio can still be heard.

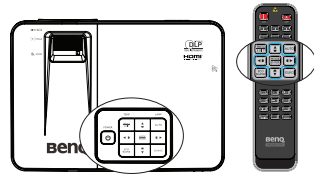

You can set the blank time in the **SYSTEM SETUP: Basic > Operation Settings > Blank Timer** menu to let the projector return the image automatically after a period of time when there is no action taken on the blank screen. The length of time can be set from 5 to 30 minutes in 5-minute increments.

- ⚠ **Do not block the projection lens from projecting as this could cause the blocking object to become heated.**
- **No matter Blank Timer is activated or not, you can press any key on the projector or remote control to restore the picture.**

Freezing the image

Press **FREEZE** on the remote control to freeze the image. The word 'FREEZE' will display in the screen. To release the function, press any key on the projector or remote control.

Even if an image is frozen on the screen, the pictures are running on the video or other device. If the connected devices have active audio output, you will still hear the audio even though the image is frozen on screen.

Operating in a high altitude environment

We recommend you use the **High Altitude Mode** when your environment is between 1500 m –3000 m above sea level, and ambient temperature is between 0°C–35°C.

- ⚠ **Do not use the High Altitude Mode if your altitude is between 0 m and 1500 m and ambient temperature is between 0°C and 35°C. The projector will be over cooled, if you turn the mode on under such a condition.**

To activate the **High Altitude Mode**:

1. Press **Menu/Exit** and then press **◀/▶** until the **SYSTEM SETUP: Advanced** menu is selected.
2. Press **▼** to select **High Altitude Mode** and press **◀/▶** to select **On**. A confirmation message displays.
3. Select **Yes** and press **Mode/Enter**.

Operation under "**High Altitude Mode**" may cause a higher decibel operating noise level because of increased fan speed necessary to improve overall system cooling and performance.

If you use this projector under other extreme conditions excluding the above, it may display auto shut-down symptoms, which is designed to protect your projector from

over-heating. In cases like this, you should switch to High Altitude mode to solve these symptoms. However, this is not to state that this projector can operate under any and all harsh or extreme conditions.

Adjusting the sound

The sound adjustments made as below will have an effect on the projector speaker(s). Be sure you have made a correct connection to the projector audio input. See "[Connection](#)" on page 21 for how the audio input is connected.

Muting the sound

To adjust the sound level, press **MUTE** on the remote control, or:

1. Press **Menu/Exit** and then press **◀ / ▶** until the **SYSTEM SETUP: Advanced** menu is selected.
2. Press **▼** to select **Audio Settings** and press **Mode/Enter**. The Audio Settings page displays.
3. Select **Mute** and select **On**.



Adjusting the sound level

To adjust the sound level, press **Volume** on the remote control or on the projector, or:

1. Repeat steps 1-2 above.
2. Select **VOLUME** and select a desired sound level.

Turning off the Power on/off ring tone

To turn off the ring tone:

1. Repeat steps 1-2 in Muting the sound section.
2. Select **Power On/Off Ring Tone** and select **Off**.

 **The only way to change Power on/off ring tone is setting On or Off here. Setting the sound mute or changing the sound level will not affect the Power on/off ring tone.**

Adjusting the microphone's sound level

To adjust the sound level:

1. Repeat steps 1-2 in Muting the sound section.
2. Select **Microphone Volume** and select a desired sound level.

 **Microphone sound will still function even though Mute is activated.**

Personalizing the projector menu display

The On-Screen Display (OSD) menus can be set according to your preferences. The following settings do not affect the projection settings, operation, or performance.

- **Language** in the **SYSTEM SETUP: Basic** menu sets your familiar language for the OSD menus. Press **Mode/Enter** to display language page. Use ▲/▼/◀/▶ and **Mode/Enter** to select your language.
- **Menu Display Time** in the **SYSTEM SETUP: Basic > Menu Settings** menu sets the length of time the OSD will remain active after your last key press. The time length ranges from 5 to 30 seconds in 5-second increments. Use ◀/▶ to select a suitable time frame.
- **Menu Position** in the **SYSTEM SETUP: Basic > Menu Settings** menu sets the OSD position in five locations. Use ◀/▶ to select a preferred position.
- **Reminder Message** in the **SYSTEM SETUP: Basic > Menu Settings** menu sets whether to display reminder messages on screen. Use ◀/▶ to select your desired setting.
- **Splash Screen** in the **SYSTEM SETUP: Basic** menu sets a preferred logo screen to be displayed during projector start-up. Use ◀/▶ to select a screen.

Select the lamp saver mode

Using the remote control.
Press **LAMP MODE** and the lamp mode selection bar appears. Use ▲/▼ to select **Normal/Economic/SmartEco**.

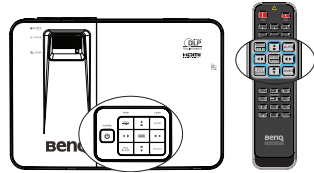

Using the OSD menu.

1. Press **Menu/Exit** and then press ◀/▶ until the **SYSTEM SETUP: Advanced** menu is selected.
2. Press ▼ to select **Lamp Settings** and press **Mode/Enter**. The Lamp Settings page displays.
3. Select **Lamp Mode** and press ◀/▶ to select **Normal/Economic/SmartEco**. The lamp brightness vary from the different lamp mode, see the description list in table below.

Lamp Mode	Description
Normal	Provides full lamp brightness
Economic	Lower brightness to extend the lamp life and decreases the fan noise
SmartEco	Adjusts the lamp power automatically depending on the content brightness level

☞ If the **Economic mode** or **SmartEco mode** is selected, the light output will be reduced and result in darker projected pictures.

Use Teaching Template

Making writing on the board easier for teachers, you can use build-in template by OSD.



Open the OSD menu and go to the **DISPLAY > Teaching Template** . Choose **Blackboard/Whiteboard > Off/Letter Formation/Worksheet/Coordinate Chart**. The Teaching Template displays.

Teaching Template	Whiteboard	Blackboard
Letter Formation		
Worksheet		
Coordinate Chart		

Shutting down the projector

1. Press **Power** on the projector. A confirmation message displays prompting you.
If you don't respond in a few seconds, the message will disappear. If you use the remote control, press OFF to shut down the projector.

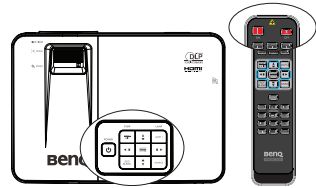

2. Press **Power** on the projector a second time. The **POWER indicator light** flashes orange, the projection lamp shuts down, and the fans will continue to run to cool down the projector.

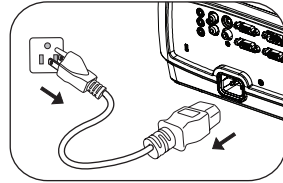

- **To protect the lamp, the projector will not respond to any commands during the cooling process.**
 - **To shorten the cooling time, you can also activate the Quick Cooling function. See "Quick Cooling" on page 60 for details.**
3. Once the cooling process finishes, the **POWER indicator light** is a steady orange and fans stop.
 4. Disconnect the power cord from the power outlet if the projector will not be used in an extended period of time.
-  **If the projector is not properly shut down, to protect the lamp, when you attempt to re-start the projector, the fans will run for a few minutes to cool down. Press Power again to start the projector after the fans stop and the POWER indicator light turns orange.**
- **Actual lamp lives may vary due to different environmental conditions and usage.**

Menu operation

Menu system

Please note that the on-screen display (OSD) menus vary according to the signal type selected.

Main menu	Sub-menu	Options	
I. DISPLAY	Wall Color	Off/Light Yellow/Pink/Light Green/Blue/Blackboard	
	Aspect Ratio	Auto/Real/4:3/16:9/16:10	
	2D Keystone		
	Corner Fit		
	Position		
	Phase		
	H. Size		
	Digital Zoom		
	3D	3D mode	Auto/Top Bottom/Frame Sequential/Frame Packing/Side by Side/Off
		3D Sync Invert	Disable/Invert
Save 3D Settings			
	Apply 3D Settings		
Teaching Template	Blackboard	Off/Letter Formation/Worksheet/Coordinate Chart	
	Whiteboard	Off/Letter Formation/Worksheet/Coordinate Chart	

	Picture Mode	Dynamic/Presentation/sRGB/Cinema/(3D)/ User 1/User 2
	Reference Mode	Dynamic/Presentation/sRGB/Cinema/(3D)
	Brightness	
	Contrast	
	Color	
	Tint	
	Sharpness	
2. PICTURE	Color Temperature	Cool/Normal/Warm
	Color Temperature Fine Tuning	R Gain/G Gain/B Gain/R Offset/ G Offset/B Offset
		Primary Color R/G/B/C/M/Y
	3D Color Management	Hue
		Saturation
		Gain
	Reset Picture Settings	Current/All/ Cancel
3. SOURCE	Quick Auto Search	On/Off
	Color Space Conversion	Auto/RGB/YUV

**4.
SYSTEM
SETUP:
Basic**

Presentation Timer	Timer Period	1~240 minutes
	Timer Display	Always /1 min/2 min/3 min/ Never
	Timer Position	Top-Left /Bottom-Left/Top- Right/Bottom-Right
	Timer Counting Direction	Count Down /Count Up
	Sound Reminder	On/ Off
	On/Off	Yes /No
Language	English / Français / Deutsch Italiano / Español / Русский 繁體中文 / 简体中文 / 日本語 / 한국어 / Svenska / Nederlands / Türkçe / Čeština / Português / हिन्दी / Polski Magyar / Български / Hrvatski / Română / Suomi / Norsk / Dansk / Indonesian / Ελληνικά / العربية / हिन्दी	
Projector Installation	Front Table /Rear Table/Rear Ceiling/Front Ceiling	
Menu Settings	Menu Display Time	5 secs/10 secs/ 20 secs /30 secs/ Always
	Menu Position	Center /Top-Left/Top-Right/ Bottom-Right/Bottom-Left
	Reminder Message	On /Off

**4.
SYSTEM
SETUP:
Basic**

Operation Settings	Direct Power On	On/ Off
	Signal Power On	Computer / YPbPr HDMI
	Auto Power Off	Disable/3 min/10 min/15 min/ 20 min /25 min/30 min
	Quick Cooling	On/ Off
	Instant Restart	On/ Off
	Blank Timer	Disable /5 min/10 min/15 min/ 20 min/25 min/30 min
	Sleep Timer	Disable /30 min/1 hr/2 hrs/3 hrs/4 hrs/8 hrs/12 hrs
Panel Key Lock	On/ Off	Yes/ No
Background Color	BenQ /Black/Blue/Purple	
Splash Screen	BenQ /Black/Blue	

**5.
SYSTEM
SETUP:
Advanced**

High Altitude Mode	On/Off	Yes/No
	Mute	On/Off
Audio Settings	Volume	0~10
	Microphone Volume	0~10
	Power On/Off Ring Tone	On/Off
	Lamp Mode	Normal/Economic/ SmartEco
Lamp Settings	Reset lamp timer	Yes/No
	Lamp Information	Lamp Usage Time
		Normal
		Economic
		SmartEco
Equivalent Lamp Hour		
Security Settings	Change Password	
	Change Security Settings	
	Power On Lock	On/Off
	Web Control Lock	On/Off
Baud Rate	2400/4800/9600/19200/38400/57600/115200	
Test Pattern	On/Off	
Closed Caption	Closed Caption Enable	On/Off
	Caption Version	CC1/CC2/CC3/CC4
Standby Settings	Network	Enable network standby mode Switch to normal standby mode
	Microphone	On/Off
	Monitor Out	On/Off
	Audio Pass Through	Off /Audio In/Audio L/R/HDMI/ Network Display

5. SYSTEM SETUP: Advanced	Network Settings	Wired LAN	Status
			DHCP
			IP Address
			Subnet Mask
			Default Gateway
			DNS Server
		Apply	
		Projection Login Code	On/ Off
		AMX Device Discovery	On/ Off
		Mac Address	
Reset All Settings	Reset/ Cancel		
6. INFORMATI ON	Current System Status	Source	
		Picture Mode	
		Lamp Mode	
		Resolution	
		3D Format	
		Color System	
		Lamp Usage Time	
Firmware Version			









Note that the menu items are available when the projector detects at least one valid signal. If there is no equipment connected to the projector or no signal detected, limited menu items are accessible.

Description of each menu



- ☞ The default values listed in this manual, especially on pages 55-64, are for reference only. They may vary between the projectors due to the continuous improvement to the products.

FUNCTION	DESCRIPTION	
Wall Color	Corrects the projected picture's color when the projection surface is not white. See "Using Wall Color" on page 39 for details.	
Aspect Ratio	There are four options to set the image's aspect ratio depending on your input signal source. See "Selecting the aspect ratio" on page 37 for details.	
2D Keystone	Corrects vertical and horizontal keystoneings of the image. See "Correcting 2D keystone" on page 29 for details.	
Corner Fit	Manually adjust four corners of the image by setting the horizontal and vertical values. See "Adjusting corner fit" on page 30 for details.	
I. DISPLAY menu	Position	Displays the position adjacent page. To move the projected image, use the directional arrow keys. The values shown on the lower position of the page change with every key press you made until they reach their maximum or minimum. ☞ This function is only available when a PC signal (analog RGB) is selected.
	Phase	Adjusts the clock phase to reduce image distortion.  ☞ This function is only available when a PC signal (analog RGB) is selected.
	H. Size	Adjusts the horizontal width of the image. ☞ This function is only available when a PC signal (analog RGB) is selected.
	Digital Zoom	Magnifies or reduces the projected image. See "Magnifying and searching for details" on page 36 for details.

FUNCTION	DESCRIPTION
<p style="writing-mode: vertical-rl; transform: rotate(180deg);">I . DISPLAY menu</p> <p style="text-align: center;">3D</p>	<p>This projector features a 3D function which enables you to enjoy the 3D movies, videos, and sporting events in a more realistic way by presenting the depth of the images. You need to wear a pair of 3D glasses to view the 3D images.</p> <p>3D Mode The default setting is Auto and the projector automatically chooses an appropriate 3D format when detecting 3D contents. If the projector cannot recognize the 3D format, press ◀/▶ to choose a 3D mode.</p> <p>3D Sync Invert When you discover the inversion of the image depth, enable this function to correct the problem.</p> <p>Save 3D Settings Save current 3D settings.</p> <p>Apply 3D Settings Apply saved 3D settings.</p>
<p>Teaching Templatee</p>	<p>Provides some templates as teaching aids. Teachers can use them for teaching. See "Use Teaching Template" on page 47 for details.</p>

FUNCTION	DESCRIPTION
Picture Mode	Pre-defined picture modes are provided so you can optimize your projector image set-up to suit your program type. See "Selecting a picture mode" on page 38 for details.
Reference Mode	<p>Selects a picture mode that best suits your need for the image quality and further fine-tune the image based on the selections listed on the same page below. See "Setting the User 1/User 2 mode" on page 38 for details.</p> <p> This function is only available when User 1 or User 2 is selected.</p>
Brightness	<p>Adjusts the brightness of the image. See "Adjusting Brightness" on page 39 for details.</p> <p> This function is only available when User 1 or User 2 is selected.</p>
Contrast	<p>Adjusts the degree of difference between dark and light in the image. See "Adjusting Contrast" on page 39 for details.</p> <p> This function is only available when User 1 or User 2 is selected.</p>
Color	<p>Adjusts the color saturation level -- the amount of each color in a video image. See "Adjusting Color" on page 39 for details.</p> <p> This function is only available when User 1 or User 2 is selected.</p> <p> This function is only available when a Video or S-Video signal is selected and the system format is NTSC or PAL.</p>
Tint	<p>Adjusts the red and green color tones of the image. See "Adjusting Tint" on page 40 for details.</p> <p> This function is only available when User 1 or User 2 is selected.</p> <p> This function is only available when a Video or S-Video signal is selected and the system format is NTSC or PAL.</p>
Sharpness	<p>Adjusts the image to make it look sharper or softer. See "Adjusting Sharpness" on page 40 for details.</p> <p> This function is only available when User 1 or User 2 is selected.</p>

2. PICTURE menu





		FUNCTION	DESCRIPTION
2. PICTURE menu		Color Temperature	See "Selecting a Color Temperature" on page 40 for details.  This function is only available when User 1/2 is selected.
		Color Temperature Fine Tuning	See "Setting a preferred color temperature" on page 40 for details.
		3D Color Management	See "3D Color Management" on page 40 for details.  This function is only available when User 1/2 is selected.
		Reset Picture Setting	See "Resetting current or all picture modes" on page 42 for details. When Picture Mode is under Dynamic, choosing "Current" will only reset the Dynamic to default value, however, choosing "All" will reset all the Picture Mode settings to default values.
3. SOURCE menu		Quick Auto Search	See "Switching input signal" on page 35 for details.
		Color Space Conversion	See "Changing Color Space" on page 36 for details.

FUNCTION	DESCRIPTION
4. SYSTEM SETUP: Basic menu Presentation Timer	Reminds the presenter to finish the presentation within a certain time frame. See "Setting the presentation timer" on page 43 for details. Timer Period Sets a preferred length of time for presentation. Timer Display Sets whether to display the timer on screen. Timer Position Sets the position where the timer displays on screen. Timer Counting Direction Sets the timer counting direction. Sound Reminder Sets a sound reminder if timer is up.
Language	Sets the language for the On-Screen Display (OSD) menus.
Projector Installation	The projector can be installed on a ceiling or behind a screen, or with one or more mirrors. See "Choosing a location" on page 17 for details.
Menu Settings	Menu Display Time Sets the length of time the OSD will remain active after your last key press. The range is from 5 to 30 seconds in 5-second increments. Menu Position Sets the On-Screen Display (OSD) menu position. Reminder Message Sets whether to display the reminder message.

FUNCTION	DESCRIPTION
<p style="writing-mode: vertical-rl; transform: rotate(180deg);">4. SYSTEM SETUP: Basic menu</p> <p>Operation Settings</p>	<p>Direct Power On Selecting On enables the function. See "Starting up the projector" on page 27 for details.</p> <p>Signal Power On Selecting On the projector will turn on automatically when VGA signal is detected. Selecting Off the projector has to be turned on manually (by keypad or remote). See "Starting up the projector" on page 27 for details.</p> <p>Auto Power Off Allows the projector to turn off automatically if no input signal is detected after a set period of time. See "Setting Auto Power Off" on page 67 for details.</p> <p>Quick Cooling Selecting On enables the function and the projector cooling time will be shortened to a few seconds.</p> <p> If you attempt to restart the projector right after the quick cooling process, it may not be turned on successfully and will rerun its cooling fans.</p> <p>Instant Restart When instant restart is on, users can restart projector immediately within 90 secs after turning off projector.</p> <p>Blank Timer Sets the image blank time when the Blank feature is activated, once elapsed the image will return to the screen. See "Hiding the image" on page 44 for details.</p> <p>Sleep Timer Sets the auto-shutdown timer. The timer can be set to a value between 30 minutes and 12 hours.</p>

	FUNCTION	DESCRIPTION
4. SYSTEM SETUP: Basic menu	Panel Key Lock	Disables or enables all panel key functions except Power on the projector and keys on the remote control.
	Background Color	Allows you to select which background color will display when no signal is input into the projector. Four options are available: BenQ logo, Black, Blue, or Purple.
	Splash Screen	Allows you to select which logo screen will display during projector start-up. Four options are available: BenQ logo, Black, or Blue.
5. SYSTEM SETUP: Advanced menu	High Altitude Mode	A mode for operation in high altitude areas. See "Operating in a high altitude environment" on page 44 for details.
	Audio Settings	<p>Allows you to enter the audio setting menu. See "Adjusting the sound" on page 45 for details.</p> <p>Mute Sets the mute function.</p> <p>Volume Adjusts the audio volume level.</p> <p>Microphone Volume Adjusts the microphone's audio volume level.</p> <p>Power On/Off Ring Tone Sets the power on/off ring tone.</p>
	Lamp Settings	<p>Lamp Mode See "Setting Lamp Mode" on page 66 for details</p> <p>Reset lamp timer See "Resetting the lamp timer" on page 71 for details.</p> <p>Lamp Information See "Getting to know the lamp hour" on page 66 for details on how the total lamp hour is calculated.</p>

FUNCTION	DESCRIPTION
Security Settings	<p>Change Password You will be asked to enter the current password before changing to a new one.</p> <p>Change Security Settings Input current password to activate Power On Lock and Web Control Lock functions.</p> <p>Power On Lock See "Securing the projector" on page 33 for details.</p> <p>Web Control Lock See "BenQ Network Projector Operation Guide" for details.</p>
Baud Rate	<p>Selects a baud rate that is identical with your computer's so that you can connect the projector using a suitable RS-232 cable. This function is intended for qualified service personnel.</p>
Test Pattern	<p>Selecting On enables the function and the projector displays the grid test pattern. It helps you adjust the image size and focus and check that the projected image is free from distortion.</p>
Closed Caption	<p>Closed Caption Enable Activates the function by selecting On when the selected input signal carries closed captions.</p> <ul style="list-style-type: none"> • Captions: An on-screen display of the dialogue, narration, and sound effects of TV programs and videos that are closed captioned (usually marked as "CC" in TV listings). <p> Set your screen aspect ratio to 4:3. This function is not available when the aspect ratio is "16:9", "16:10" or "Real".</p> <p>Caption Version Selects a preferred closed captioning mode. To view captions, select CC1, CC2, CC3, or CC4 (CC1 displays captions in the primary language in your area).</p>

FUNCTION	DESCRIPTION
Standby Settings	<p>Network</p> <p>Enable network standby mode Selecting On enables the function, and the projector can be monitored or controlled over a network when it is in standby mode.</p> <p>Switch to normal standby mode Sets the timer to switch to normal standby mode.</p> <p>Microphone Selecting On enables the function, and the microphone can be used even in standby mode.</p> <p>Monitor Out Selecting On enables the function. The projector can output a VGA signal when it is in standby mode and the COMPUTER I and MONITOR-OUT jacks are correctly connected to devices. See "Connecting a monitor" on page 23 for how to make the connection.</p> <p> Enabling this function slightly increases the standby power consumption.</p> <p> The Monitor Out only works when an appropriate D-Sub input is made to the COMPUTER I jack.</p> <p>Audio Pass Through The projector can play sound when it is in standby mode and the corresponding jacks are correctly connected to devices. Press ◀ / ▶ to choose the source that you wish to use. See "Connection" on page 21 for how to make the connection.</p> <p> Enabling this function slightly increases the standby power consumption.</p>
Network Settings	See "BenQ Network Projector Operation Guide" for details.
Reset All Settings	<p>Returns all settings to the factory preset values.</p> <p> The following settings will still remain: User 1, User 2, Projector Installation, Color Space Conversion, High Altitude Mode, Security Settings, Baud Rate and Network Settings</p>

FUNCTION	DESCRIPTION
<p style="writing-mode: vertical-rl; transform: rotate(180deg);">6. INFORMATION menu</p> <p>Current System Status</p>	<p>Source Shows the current signal source.</p> <p>Picture Mode Shows the selected mode in the PICTURE menu.</p> <p>Lamp Mode Shows the current lamp mode.</p> <p>Resolution Shows the native resolution of the input signal.</p> <p>3D Format Shows the current 3D mode.</p> <p>Color System Shows input system format, NTSC, PAL, SECAM, or RGB.</p> <p>Lamp Usage Time Displays the number of hours the lamp has been used.</p> <p>Firmware Version Shows firmware version.</p>

Maintenance

Care of the projector

Your projector needs little maintenance. The only thing you need to do on a regular basis is to keep the lens and case clean.

Never remove any parts of the projector except the lamp. Contact your dealer if other parts need replacing.

Cleaning the lens

Clean the lens whenever you notice dirt or dust on the surface.

- Use a canister of compressed air to remove dust.
- If there is dirt or smears, use lens-cleaning paper or moisten a soft cloth with lens cleaner and gently wipe the lens surface.
- Never use any type of abrasive pad, alkaline/acid cleaner, scouring powder, or volatile solvent, such as alcohol, benzene, thinner or insecticide. Using such materials or maintaining prolonged contact with rubber or vinyl materials may result in damage to the projector surface and cabinet material.

 **Never rub the lens with abrasive materials.**

Cleaning the projector case

Before you clean the case, turn the projector off using the proper shutdown procedure as described in "[Shutting down the projector](#)" on page 48 and unplug the power cord.

- To remove dirt or dust, wipe the case with a soft, lint-free cloth.
- To remove stubborn dirt or stains, moisten a soft cloth with water and a neutral pH detergent. Then wipe the case.

 **Never use wax, alcohol, benzene, thinner or other chemical detergents. These can damage the case.**

Storing the projector

If you need to store the projector for an extended time, please follow the instructions below:

- Make sure the temperature and humidity of the storage area are within the recommended range for the projector. Please refer to "[Specifications](#)" on page 75 or consult your dealer about the range.
- Retract the adjuster feet.
- Remove the battery from the remote control.
- Pack the projector in its original packing or equivalent.

Transporting the projector

It is recommended that you ship the projector with its original packing or equivalent.

Lamp information

Getting to know the lamp hour

When the projector is in operation, the duration (in hours) of lamp usage is automatically calculated by the built-in timer. The method of calculating the equivalent lamp hour is as follows:

Total (equivalent) lamp hour
= 1 (hours used in Economic mode) + 4/3 (hours used in normal mode)

 See "**Setting Lamp Mode**" below for more information on **Economic mode**.

The lamp hour in Economic mode is calculated as 3/4 of that in Normal mode. That is, using the projector in Economic mode helps to extend the lamp hour by 1/3.

To obtain the lamp hour information:

1. Press **Menu/Exit** and then press **◀/▶** until the **SYSTEM SETUP: Advanced** menu is selected.
2. Press **▼** to select **Lamp Settings** and press **Mode/Enter**. The **Lamp Settings** page displays.
3. Select **Lamp Information** and press **Mode/Enter**.
4. You will see the **Equivalent Lamp Hour** information displaying on the menu.
5. To leave the menu, press **Menu/Exit**.

You can also get the lamp hour information on the **INFORMATION** menu.

Extending lamp life

The projection lamp is a consumable item. To keep the lamp life as long as possible, you can do the following settings via the OSD menu or remote control.

Setting Lamp Mode

Using Economic /**SmartEco** mode will reduce system noise and power consumption. If the Economic/**SmartEco** mode is selected, the light output will be reduced and result in darker projected pictures, the projector protected for longer working life.

Setting the projector in Economic/**SmartEco** mode also extends the lamp operation life. To set Economic/**SmartEco** mode, go into the **SYSTEM SETUP: Advanced > Lamp Settings > Lamp Mode** menu and press **◀/▶** . .

The lamp modes are defined as the chart below.

Lamp Mode	Description
Normal	Provides full lamp brightness
Economic	Lower brightness to extend the lamp life and decreases the fan noise
SmartEco	Adjusts the lamp power automatically depending on the content brightness level

Setting Auto Power Off

This function allows the projector to turn off automatically if no input source is detected after a set period of time to prevent unnecessary waste of lamp life.

To set **Auto Power Off**, go into the **SYSTEM SETUP: Basic > Operation Settings > Auto Power Off** menu and press ◀/▶. The time period can be set from 5 to 30 minutes in 5-minute increments. If the preset time lengths are not suitable for your presentation, select **Disable**. The projector will not automatically shut down in a certain time period.

Timing of replacing the lamp

When the Lamp indicator lights up red or a message appears suggesting it is time to replace the lamp, please install a new lamp or consult your dealer. An old lamp may cause a malfunction in the projector and in some instances the lamp may explode.

 **The Lamp indicator light and Temperature warning light will light up if the lamp becomes too hot. See "Indicators" on page 72 for details.**

The following lamp warning displays will remind you to change the lamp.

 **The warning messages below are for reference only. Please follow the actual on-screen instructions to prepare and replace the lamp.**

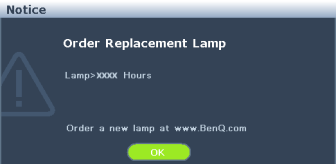
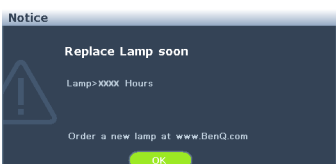
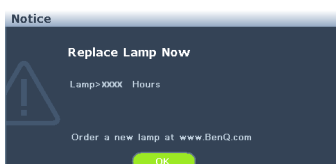
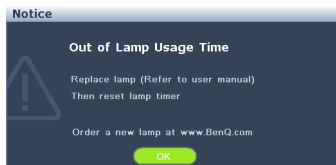
Status	Message
<p>Install a new lamp for optimal performance. If the projector is normally run with Economic selected ("Setting Lamp Mode" on page 66), you may continue to operate the projector until the next lamp warning appears.</p>	
<p>A new lamp should be fitted to avoid the inconvenience when the projector runs out of lamp time.</p>	
<p>It is strongly recommended that you replace the lamp at this stage. The lamp is a consumable item. The lamp brightness diminishes with use. This is normal lamp behavior. You can replace the lamp whenever you notice that the brightness level has significantly diminished.</p>	
<p>The lamp MUST be replaced before the projector will operate normally.</p>	

 **"XXXX" shown in the above messages are numbers that vary depending on different models.**

Replacing the lamp (FOR SERVICE PERSONNEL ONLY)



- **Hg - Lamp contains mercury. Manage in accordance with local disposal laws. See www.lamprecycle.org.**
 - **If lamp replacement is performed while the projector is suspended upside-down from the ceiling, make sure that no one is underneath the lamp socket to avoid any possible injury or damage to the human eyes caused by fractured lamp.**
 - **To reduce the risk of electrical shock, always turn the projector off and disconnect the power cord before changing the lamp.**
 - **To reduce the risk of severe burns, allow the projector to cool for at least 45 minutes before replacing the lamp.**
 - **To reduce the risk of injuries to fingers and damage to internal components, use caution when removing lamp glass that has shattered into sharp pieces.**
 - **To reduce the risk of injuries to fingers and/or compromising image quality by touching the lens, do not touch the empty lamp compartment when the lamp is removed.**
 - **This lamp contains mercury. Consult your local hazardous waste regulations to dispose of this lamp in a proper manner.**
 - **To assure optimal performance from the projector, it is recommended that you purchase a BenQ projector lamp for lamp replacement.**
 - **Ensure good ventilation when handling broken lamps. We recommend that you use respirators, safety glasses, goggles or face shield and wear protective clothing such as gloves.**
1. **Turn the power off and disconnect the projector from the power outlet. If the lamp is hot, avoid burns by waiting for approximately 45 minutes until the lamp has cooled.**
 2. **Loosen the screw on the lamp cover.**

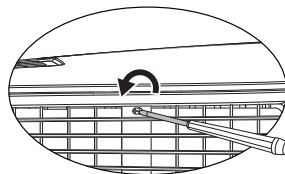

3. Remove the lamp cover by (a) pushing the lamp cover upward and (b) lifting it off.



- **Do not turn the power on with the lamp cover removed.**
- **Do not insert your fingers between the lamp and the projector. The sharp edges inside the projector may cause injuries.**

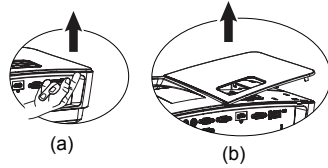

4. Loosen the screws that secure the lamp.

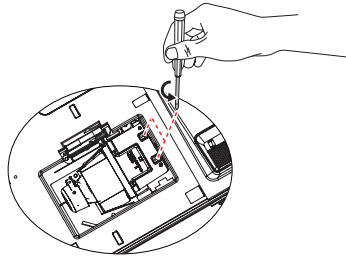

5. Lift the handle so that it stands up. Use the handle to slowly pull the lamp out of the projector.



- **Pulling it too quickly may cause the lamp to break and scatter broken glass in the projector.**
- **Do not place the lamp in locations where water might splash on it, children can reach it, or near flammable materials.**
- **Do not insert your hands into the projector after the lamp is removed. If you touch the optical components inside, it could cause color unevenness and distortion of the projected images.**

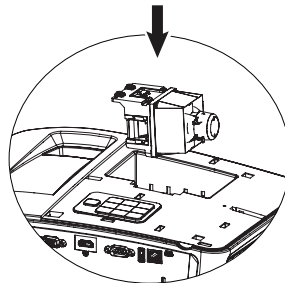
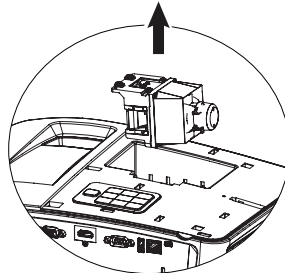

6. Insert the new lamp into the lamp compartment and make sure it fits in the projector.

7. Tighten the screws that secure the lamp.

 • **Loose screw may cause a bad connection, which could result in malfunction.**

- **Do not over tighten the screws.**

8. Ensure the handle is fully laid flat and locked in place.

9. Replace the lamp cover by sliding it into place.

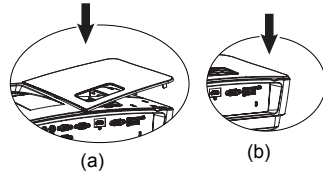
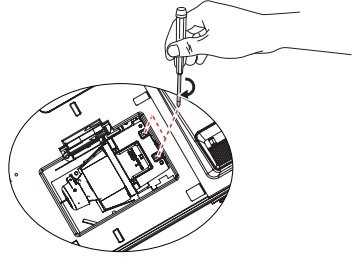

10. Tighten the screw that secures the lamp cover.

 • **Loose screw may cause a bad connection, which could result in malfunction.**

- **Do not over tighten the screw.**

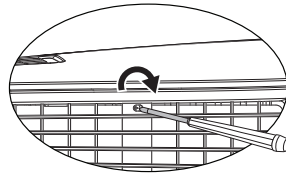

11. Restart the projector.

 • **Do not turn the power on with the lamp cover removed.**

Resetting the lamp timer

12. After the startup logo, open the On-Screen Display (OSD) menu. Go to the **SYSTEM SETUP: Advanced > Lamp Settings** menu. Press **Mode/Enter**. The **Lamp Settings** page displays. Press **▼** to select **Reset lamp timer** and press **Mode/Enter**. A warning message displays asking if you want to reset the lamp timer. Select **Yes** and press **Mode/Enter**. The lamp time will be reset to '0'.

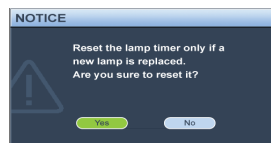

 • **Do not reset if the lamp is not new or replaced as this could cause damage.**

Indicators

Light				Status & Description
POWER	TEMP	LAMP I	LAMP2	
Power events				
Orange	Off	Off	Off	Stand-by
Green Flashing	Off	Off	Off	Powering up
Green	Off	Off	Off	Normal operation
Orange Flashing	Off	Off	Off	Normal power-down cooling
Red	Off	Off	Off	Download
Green	Off	Red	Off	CW start fail
Red Flashing	Off	Off	Off	Scaler shutdown fail (data abort)
Red	Off	Red	Off	Scaler reset fail (video projector only)
Off	Red	Off	Off	LAN download fail
Off	Green	Off	Off	LAN download processing
Burn-in message				
Green	Off	Off		Burn-in ON
Green	Green	Green		Burn-in OFF
Lamp error messages				
Off	Off	Red	Off	Lamp I error in normal operation
Off	Off	Orange	Off	Lamp is not lit up
Thermal error messages				
Red	Red	Off	Off	Fan 1 error (the actual fan speed is $\pm 25\%$ outside the desired speed)
Red	Red Flashing	Off	Off	Fan 2 error (the actual fan speed is $\pm 25\%$ outside the desired speed)
Red	Green	Off	Off	Fan 3 error (the actual fan speed is $\pm 25\%$ outside the desired speed)
Green	Red	Off	Off	Temperature 1 error (over limited temperature)
Green	Red Flashing	Off	Off	Thermal Sensor 1 open error
Green	Green	Off	Off	Thermal Sensor 1 short error
Green	Green Flashing	Off	Off	Thermal IC #1 I2C Connection error
Green Flashing	Red	Off	Off	Temperature 2 error (over limited temperature)
Green Flashing	Red Flashing	Off	Off	Thermal Sensor 2 open error

Green Flashing	Green	Off	Off	Thermal Sensor 2 short error
Green Flashing	Green Flashing	Off	Off	Thermal IC #2 I2C Connection error

Troubleshooting

? The projector does not turn on.

Cause	Remedy
There is no power from the power cable.	Plug the power cord into the AC inlet on the projector, and plug the power cord into the power outlet. If the power outlet has a switch, make sure that it is switched on.
Attempting to turn the projector on again during the cooling process.	Wait until the cooling down process has completed.

? No picture

Cause	Remedy
The video source is not turned on or connected correctly.	Turn the video source on and check that the signal cable is connected correctly.
The projector is not correctly connected to the input signal device.	Check the connection.
The input signal has not been correctly selected.	Select the correct input signal with the Source key on the projector or remote control.
The lens cover is still closed.	Open the lens cover.

? Blurred image

Cause	Remedy
The projection lens is not correctly focused.	Adjust the focus of the lens using the focus ring.
The projector and the screen are not aligned properly.	Adjust the projection angle and direction as well as the height of the unit if necessary.
The lens cover is still closed.	Open the lens cover.

? Remote control does not work

Cause	Remedy
The battery is out of power.	Replace the battery with new one.
There is an obstacle between the remote control and the projector.	Remove the obstacle.
You are too far away from the projector.	Stand within 8 meters (26 feet) of the projector.

? The password is incorrect

Cause	Remedy
You do not remember the password.	Please see " Entering the password recall procedure " on page 34 for details.

Specifications

 All specifications are subject to change without notice.

Optical

Resolution

(MX723)

1024 x 768 XGA

(MW724)

1280 x 800 WXGA

Display system

I-CHIP DMD

Lens F/Number

(MX723)

F= 2.5~3.12

f= 16mm~25.46mm

(MW724)

F= 2.41~2.78

f= 15.76mm~21.11mm

Offset

(MX723) 130%

(MW724) 125%

Zoom ratio

(MX723) 1.6X

(MW724) 1.36X

Lamp

(MX723) 260W

(MW724) 240W

Electrical

Power supply

AC100~240V, 3.4 A,

50-60 Hz (Automatic)

Power consumption

(MX723) 335W (Max.); < 0.5 W; < 6 W

(when the Network function in the Standby Settings is on)

(MW724) 315W (Max.); < 0.5 W; < 6 W

(when the Network function in the Standby Settings is on)

Mechanical

Weight

(MX723) 2.9 kg

(MW724) 3.0 kg

Output terminals

RGB output

D-Sub 15-pin (female) x 1

Speaker

(Stereo) 10 watt x 1

Audio signal output

PC audio jack x 1

Control

IR receiver x 1 (front)

RS-232 serial control

9 pin x 1

LAN control

Wired (RJ45)

USB

Mini B

Supports firmware upgrade

Type A

1.5A output

Input terminals

Computer input

RGB input

D-Sub 15-pin (female) x 2

Video signal input

S-VIDEO

Mini DIN 4-pin port x 1

VIDEO

RCA jack x 1

SD/HDTV signal input

Analog - Component RCA jack x 3
(through RGB input)

Digital-HDMI x 1

Audio signal input

Audio in

PC audio jack x 1 for audio input

PC audio jack x 1 for microphone
audio input

RCA audio jack (L/R) x 2

Environmental Requirements

Operating temperature

0°C-40°C at sea level

Operating relative humidity

10%-90% (without condensation)

Operating altitude

0-1499 m at 0°C-35°C

1500-3000 m at 0°C-30°C (with High

Altitude Mode on)

 Lamp life results will vary depending on environmental conditions and usage.

Dimensions

327.3 mm (W) × 136.7 mm (H) × 232.8 mm (D)

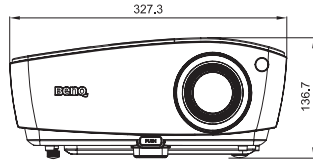
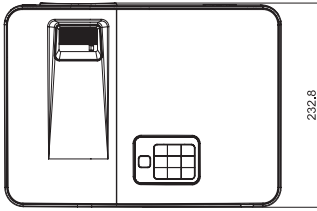

Ceiling mount installation

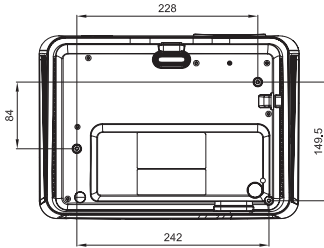

Ceiling mount screw: M4
(Max L = 25 mm; Min L = 20 mm)

Unit: mm

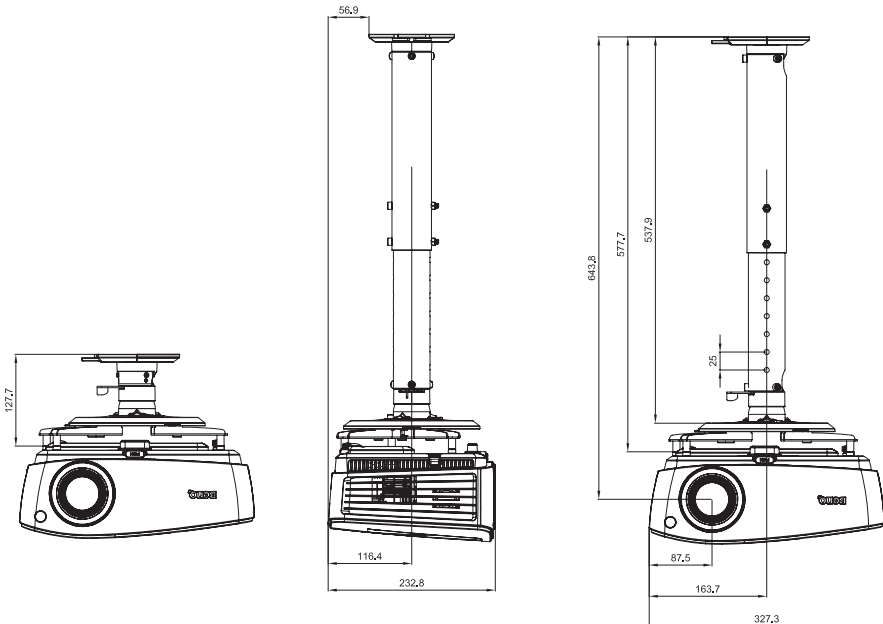

Timing chart

Supported timing for PC input

Resolution	Timing	Horizontal Frequency (KHz)	Vertical Frequency (Hz)	Pixel Frequency (MHz)	3D Field Sequential	3D top bottom	3D side by side
640 x 480	VGA_60	59.94	31.469	25.175	○	○	○
	VGA_72	72.809	37.861	31.500			
	VGA_75	75	37.5	31.500			
	VGA_85	85.008	43.269	36.000			
720 x 400	720 x 400_70	70.087	31.469	28.3221			
800 x 600	SVGA_60	60.317	37.879	40.000	○	○	○
	SVGA_72	72.188	48.077	50.000			
	SVGA_75	75	46.875	49.500			
	SVGA_85	85.061	53.674	56.250			
	SVGA_120 (Reduce Blanking)	119.854	77.425	83.000	○		
1024 x 768	XGA_60	60.004	48.363	65.000	○	○	○
	XGA_70	70.069	56.476	75.000			
	XGA_75	75.029	60.023	78.750			
	XGA_85	84.997	68.667	94.500			
	XGA_120 (Reduce Blanking)	119.989	97.551	115.5	○		
1152 x 864	1152 x 864_75	75	67.5	108			
1024 x 576	BenQ Notebook Timing	60	35.82	46.966			
1024 x 600	BenQ Notebook Timing	64.995	41.467	51.419			
1280 x 720	1280 x 720_60	60	45	74.250	○	○	○
	1280 x 720_120	120	90.000	148.500	○		
1280 x 768	1280 x 768_60	59.87	47.776	79.5	○	○	○
1280 x 800	WXGA_60	59.81	49.702	83.500	○	○	○
	WXGA_75	74.934	62.795	106.500			
	WXGA_85	84.88	71.554	122.500			
	WXGA_120 (Reduce Blanking)	119.909	101.563	146.25	○		
1280 x 1024	SXGA_60	60.02	63.981	108.000		○	○
	SXGA_75	75.025	79.976	135.000			
	SXGA_85	85.024	91.146	157.500			
1280 x 960	1280 x 960_60	60	60	108.000		○	○
	1280 x 960_85	85.002	85.938	148.500			
1360 x 768	1360 x 768_60	60.015	47.712	85.5		○	○
1440 x 900	WXGA+_60	59.887	55.935	106.500		○	○
1400 x 1050	SXGA+_60	59.978	65.317	121.750		○	○
1600 x 1200	UXGA	60	75	162.000		○	○

1680 x 1050	1680 x 1050_60	59.954	65.29	146.25		⊙	⊙
1920 x 1080	1920 x 1080_60 (Reduce Blanking)	67.5	60	148.5			
1920 x 1200	1920 x 1200_60 (Reduce Blanking)	59.95	74.038	154.000			
640 x 480 @67Hz	MAC13	66.667	35	30.240			
832 x 624 @75Hz	MAC16	74.546	49.722	57.280			
1024 x 768 @75Hz	MAC19	75.02	60.241	80.000			
1152 x 870 @75Hz	MAC21	75.06	68.68	100.000			

- The timings showing above may not be supported due to EDID file and VGA graphic card limitations. It is possible that some timings cannot be chosen.

Supported timing for HDMI (HDCP) input

Resolution	Timing	Horizontal Frequency (KHz)	Vertical Frequency y (Hz)	Pixel Frequency (MHz)	3D Field Sequential	3D top bottom	3D side by side
640 x 480	VGA_60	59.94	31.469	25.175	⊙	⊙	⊙
	VGA_72	72.809	37.861	31.500			
	VGA_75	75	37.5	31.500			
	VGA_85	85.008	43.269	36.000			
720 x 400	720 x 400_70	70.087	31.469	28.3221			
800 x 600	SVGA_60	60.317	37.879	40.000	⊙	⊙	⊙
	SVGA_72	72.188	48.077	50.000			
	SVGA_75	75	46.875	49.500			
	SVGA_85	85.061	53.674	56.250			
	SVGA_120 (Reduce Blanking)	119.854	77.425	83.000	⊙		
1024 x 768	XGA_60	60.004	48.363	65.000	⊙	⊙	⊙
	XGA_70	70.069	56.476	75.000			
	XGA_75	75.029	60.023	78.750			
	XGA_85	84.997	68.667	94.500			
	XGA_120 (Reduce Blanking)	119.989	97.551	115.5	⊙		
1152 x 864	1152 x 864_75	75	67.5	108			
1024 x 576	BenQ Notebook Timing	60	35.82	46.966			
1024 x 600	BenQ Notebook Timing	64.995	41.467	51.419			
1280 x 720	1280 x 720_60	60	45	74.250	⊙	⊙	⊙
1280 x 768	1280 x 768_60	59.87	47.776	79.5	⊙	⊙	⊙

1280 x 800	WXGA_60	59.81	49.702	83.500	⊙	⊙	⊙
	WXGA_75	74.934	62.795	106.500			
	WXGA_85	84.88	71.554	122.500			
	WXGA_120 (Reduce Blanking)	119.909	101.563	146.25	⊙		
1280 x 1024	SXGA_60	60.02	63.981	108.000		⊙	⊙
	SXGA_75	75.025	79.976	135.000			
	SXGA_85	85.024	91.146	157.500			
1280 x 960	1280 x 960_60	60	60	108.000		⊙	⊙
	1280 x 960_85	85.002	85.938	148.500			
1360 x 768	1360 x 768_60	60.015	47.712	85.5		⊙	⊙
1440 x 900	WXGA+_60	59.887	55.935	106.500		⊙	⊙
1400 x 1050	SXGA+_60	59.978	65.317	121.750		⊙	⊙
1600 x 1200	UXGA	60	75	162.000		⊙	⊙
1680 x 1050	1680 x 1050_60	59.954	65.29	146.25		⊙	⊙
640 x 480 @67Hz	MAC13	66.667	35	30.240			
832 x 624 @75Hz	MAC16	74.546	49.722	57.280			
1024 x 768 @75Hz	MAC19	75.02	60.241	80.000			
1152 x 870 @75Hz	MAC21	75.06	68.68	100.000			
1920 x 1080	1920 x 1080_60 (Reduce Blanking)	67.5	60	148.5			
1920 x 1200	1920 x 1200_60 (Reduce Blanking)	59.95	74.038	154.000			

The timings showing above may not be supported due to EDID file and VGA graphic card limitations. It is possible that some timings cannot be chosen.

Supported 3D signal for Video input

Video mode	Horizontal Frequency (kHz)	Vertical Frequency (Hz)	Color sub-carrier Frequency (MHz)	3D Field Sequential
NTSC	15.73	60	3.58	⊙
PAL	15.63	50	4.43	
SECAM	15.63	50	4.25 or 4.41	
PAL-M	15.73	60	3.58	
PAL-N	15.63	50	3.58	
PAL-60	15.73	60	4.43	
NTSC4.43	15.73	60	4.43	

Supported timing for Component-YPbPr input

Timing	Resolution	Horizontal Frequency (KHz)	Vertical Frequency (Hz)	Pixel Frequency (MHz)	3D Field Sequential
480i	720 x 480	15.73	59.94	13.5	⊙

480p	720 × 480	31.47	59.94	27	◎
576i	720 × 576	15.63	50	13.5	
576p	720 × 576	31.25	50	27	
720/50p	1280 × 720	37.5	50	74.25	
720/60p	1280 × 720	45.00	60	74.25	◎
1080/50i	1920 × 1080	28.13	50	74.25	
1080/60i	1920 × 1080	33.75	60	74.25	
1080/24P	1920 × 1080	27	24	74.25	
1080/25P	1920 × 1080	28.13	25	74.25	
1080/30P	1920 × 1080	33.75	30	74.25	
1080/50P	1920 × 1080	56.25	50	148.5	
1080/60P	1920 × 1080	67.5	60	148.5	

Warranty and Copyright information

Patents

Please go to <http://patmarking.benq.com/> for the details on BenQ projector patent coverage.

Limited warranty

BenQ warrants this product against any defects in material and workmanship, under normal usage and storage.

Proof of purchase date will be required with any warranty claim. In the event this product is found to be defective within the warranty period, BenQ's only obligation and your exclusive remedy shall be replacement of any defective parts (labor included). To obtain warranty service, immediately notify the dealer from which you purchased the product of any defects.

Important: The above warranty shall be void if the customer fails to operate the product in accordance with BenQ's written instructions, especially the ambient humidity must be in-between 10% and 90%, temperature in-between 0°C and 35°C, altitude lower than 4920 feet, and avoiding to operate the projector in a dusty environment. This warranty gives you specific legal rights, and you may have other rights which vary from country to country.

For other information, please visit www.BenQ.com.

Copyright

Copyright 2014 by BenQ Corporation. All rights reserved. No part of this publication may be reproduced, transmitted, transcribed, stored in a retrieval system or translated into any language or computer language, in any form or by any means, electronic, mechanical, magnetic, optical, chemical, manual or otherwise, without the prior written permission of BenQ Corporation.

Disclaimer

BenQ Corporation makes no representations or warranties, either expressed or implied, with respect to the contents hereof and specifically disclaims any warranties, merchantability or fitness for any particular purpose. Further, BenQ Corporation reserves the right to revise this publication and to make changes from time to time in the contents hereof without obligation to notify any person of such revision or changes.

*DLP, Digital Micromirror Device and DMD are trademarks of Texas Instruments. Others are copyrights of their respective companies or organizations.