

Table of Content

IMPORTANT SAFETY INSTRUCTIONS	1
Read before operating equipment	1
Compliance Information	3
CE Conformity for European Countries.....	3
Declaration of RoHS Compliance.....	4
PREPARATION	6
Before installation.....	6
Package contents.....	7
Installation of batteries.....	7
TV INSTALLATION	8
Mount the TV stand	8
TV connectors.....	8
Wall mounting	9
Remove the TV stand for wall mounting	9
Connect the device.....	10
Rear connections	10
Side connections.....	11
Power connection.....	12
Turning the LCD TV on.....	12
First time installation.....	13
Control panel buttons	14
Remote control functions	15
Picture format	17
TV menu.....	18
OSD Settings	18
Picture	19
Sound.....	20
TV	21
TV/Channels	22
Installation	24
Parental	26
Other information	27
Troubleshooting	27
Glossary	28
Specifications.....	29

IMPORTANT SAFETY INSTRUCTIONS

Read before operating equipment

1. Read these instructions.
2. Keep these instructions.
3. Heed all warnings.
4. Follow all instructions.
5. Do not use this apparatus near water.
6. Clean only with a dry cloth.
7. Do not block any of the ventilation openings. Install in accordance with the manufacturers instructions.
8. Do not install near any heat sources such as radiators, heat registers, stoves, or other apparatus (including amplifiers) that produce heat.
9. Do not defeat the safety purpose of the polarized or grounding-type plug. A polarized plug has two blades with one wider than the other. A grounding type plug has two blades and a third grounding prong. The wide blade or the third prong are provided for your safety. When the provided plug does not fit into your outlet, consult an electrician for replacement of the obsolete outlet.
10. Protect the power cord from being walked on or pinched particularly at plugs, convenience receptacles, and the point where they exit from the apparatus.
11. Only use attachments/accessories specified by the manufacturer.
12.  Use only with a cart, stand, tripod, bracket, or table specified by the manufacturer, or sold with the apparatus. When a cart is used, use caution when moving the cart/apparatus combination to avoid injury from tip-over.
13. Unplug this apparatus during lightning storms or when unused for long periods of time.
14. Refer all servicing to qualified service personnel. Servicing is required when the apparatus has been damaged in any way, such as power-supply cord or plug is damaged, liquid has been spilled or objects have fallen into apparatus, the apparatus has been exposed to rain or moisture, does not operate normally, or has been dropped.
15. Apparatus shall not be exposed to dripping or splashing and no objects fill with liquids, such as vases, shall be placed on the apparatus.
16. To reduce the risk of electric shock, do not remove the cover of the apparatus. Refer any servicing to appointed service personnel.

17. The readily operable appliance coupler will serve as the disconnecting device of this apparatus.
18. The apparatus must be connected to a mains socket outlet with a protected earthed connection.
19. Used or discharged batteries must be properly disposed of or recycled in compliance with all applicable laws. For detailed information, contact your local solid waste disposal authority.
20. When purchased or used in different countries, use an appropriate power cable which is compliant with local laws and regulations.
21. To prevent injury, this apparatus must be securely attached to the floor/wall in accordance with the installation instructions
22. Do not install this equipment in a confined space such a book case or similar unit.
23. No naked flame sources, such as lighted candles, should be placed on the apparatus.
24. For ventilation, leave at least 4" to 6" free all around the TV. Do not place the TV on a carpet.
25. The equipment shall not be exposed to dripping or splashing.
26. The equipment shall not be exposed to rain or moisture and objects filled with liquids, such as vases, shall be placed on the apparatus.
27. The apparatus must be connected to a mains socket outlet with a protected earthed connection.
28. The device is not intended for use at visual display work places acc. BildscharbV.
29. The appliance coupler is used as the disconnect device of this apparatus, the disconnect device shall remain readily operable.

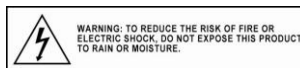

This symbol is used to indicate uninsulated "dangerous voltage" within the product's enclosure that may cause electric shock.



The exclamation point within an equilateral triangle is intended to alert the user to the important operating and maintenance (servicing) instructions in the literature accompanying the appliance.

CAUTION

These servicing instructions are for use by qualified service personnel only. To reduce the risks of electric shock do not perform any servicing other than that contained in the operating instructions unless you are qualified to do so.

Disposal of Waste Equipment by Users in Private Household in the European Union.



This symbol on the product or on its packaging indicates that this product must not be disposed of with your other household waste. Instead, it is your responsibility to dispose of your waste equipment by handing it over to a designated collection point for the recycling of waste electrical and electronic equipment. The separate collection and recycling of your waste equipment at the time of disposal will help to conserve natural resources and ensure that it is recycled in a manner that protects human health and the environment. For more information about where you can drop off your waste equipment for recycling, please contact your local city office, your household waste disposal service or the shop where you purchased the product.

Compliance Information

CE Conformity for European Countries



The device complies with the requirements of the EEC directive 89/336/EEC as amended by 92/31/EEC and 93/68/EEC Art.5 with regard to "Electromagnetic compatibility", and 73/23/EEC as amended by 93/68/EEC Art.13 with regard to "Safety".

Declaration of RoHS Compliance

This product has been designed and manufactured in compliance with Directive 2002/95/EC of the European Parliament and the Council on restriction of the use of certain hazardous substances in electrical and electronic equipment (RoHS Directive) and is deemed to comply with the maximum concentration values issued by the European Technical Adaptation Committee (TAC) as shown below:

Substance	Proposed Maximum Concentration	Actual Concentration
Lead (Pb)	0.1%	< 0.1%
Mercury (Hg)	0.1%	< 0.1%
Cadmium (Cd)	0.01%	< 0.01%
Hexavalent Chromium (Cr ⁶⁺)	0.1%	< 0.1%
Polybrominated biphenyls (PBB)	0.1%	< 0.1%
Polybrominated biphenyl ethers (PBDE)	0.1%	< 0.1%

Certain components of products as stated above are exempted under the Annex of the RoHS Directives as noted below:

Examples of exempted components are:

1. Mercury in compact fluorescent lamps not exceeding 5 mg per lamp and in other lamps not specifically mentioned in the Annex of RoHS Directive.
2. Lead in glass of cathode ray tubes, electronic components, fluorescent tubes, and electronic ceramic parts (e.g. piezoelectronic devices).
3. Lead in high temperature type solders (i.e. lead-based alloys containing 85% by weight or more lead).
4. Lead as an alloying element in steel containing up to 0.35% lead by weight, aluminium containing up to 0.4% lead by weight and as a copper alloy containing up to 4% lead by weight.



LCD panel

The LCD panel used in this product is made of glass. Therefore, it can break when the product is dropped or impacted upon by other objects.

The LCD panel is a very high technology product, giving you finely detailed pictures. Occasionally, a few non-active pixels may appear on the screen as a fixed point of blue, green or red. This does not affect the performance of your product.

In order to ensure long performance of your set and reduce the risk of screen burning, please observe the following precautions.

- Do not display still images (still computer and video game images, logos, pictures, text and images displayed in 4:3) for extended periods of time;
- Use a screen saver when using a computer:

PREPARATION

Before installation

1. Place the TV on a solid surface.

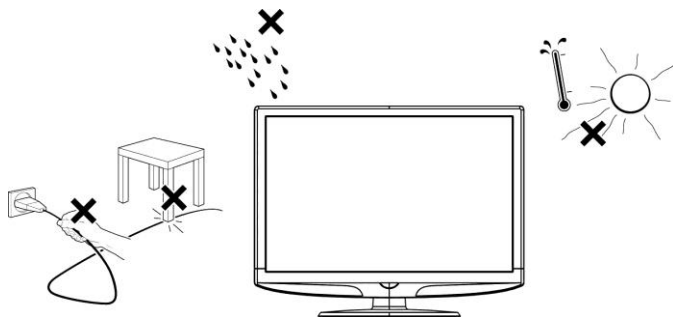

Ensure that the TV is placed in a position to allow free flow of air.

Do not cover the ventilation openings on the back cover.

To prevent any unsafe situations, no naked flame sources, such as lighted candles, should be placed on or in the vicinity.

Avoid heat, direct sunlight and exposure to rain or water.

The equipment shall not be exposed to dripping or splashing.

2. **Insert the aerial plug** firmly into the aerial socket

ANT IN 75Ω at the back of the TV.

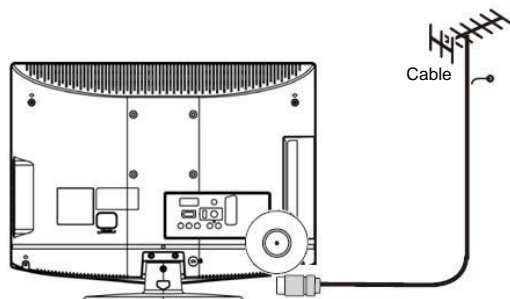

PREPARATION

Package contents

Please verify that you received the following items with your package contents:

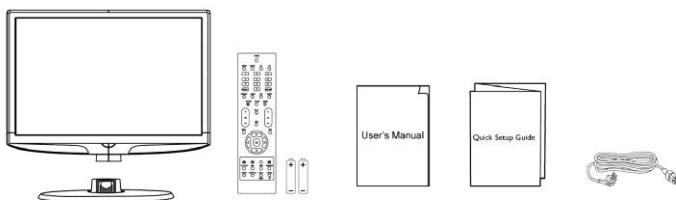

1. LCD TV
2. Base
3. Remote control with batteries
4. User's Manual
5. Quick Setup Guide
6. Power cord x 1 (UK or Europe)

Installation of batteries

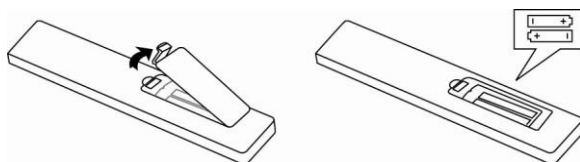

1. Insert two AAA batteries into Remote control. Make sure + and – are facing the proper direction.
2. Replace the cover.

* If the remote control will not to be used for a long time, remove the batteries to avoid remote control damage.

Mount the TV stand-

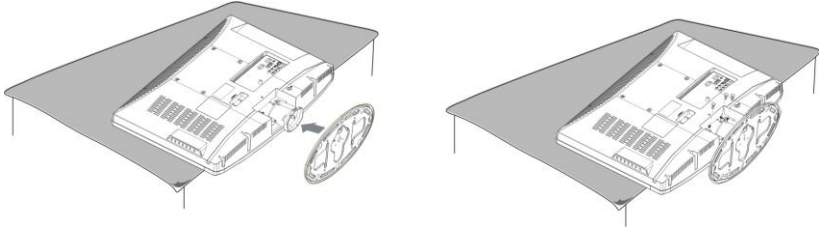

1. Put the TV face down on a safe surface that is covered by a soft and smooth cloth.
2. Click the TV stand to the base column.
3. Fix the 3 bolts securely using the holes in the back of the TV (26") .

TV connectors

Front views

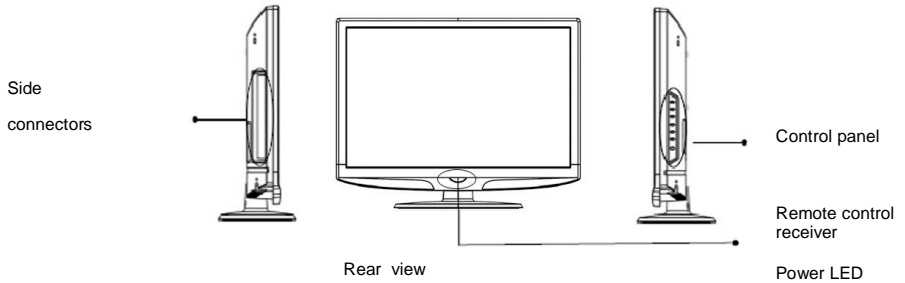

Rear view

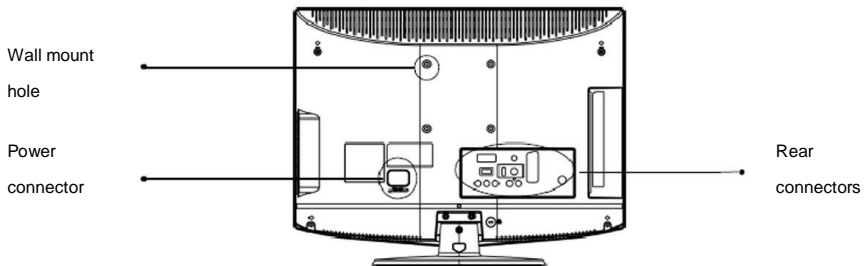

Wall mounting

	TV screen size (inches)	VESA-compatible wall bracket (millimeters) (W X H)	Screw type
	19"	100 x 100 mm	Metric 4 x 10 mm
	22"	100 x 100 mm	Metric 4 x 10 mm
	26"	200 x 100 mm	Metric 4 x 10 mm

Remove the TV stand for wall mounting

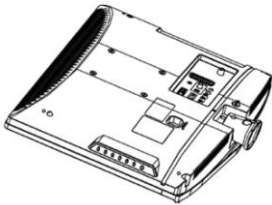

1. Put the TV face down on a safe surface that is covered by a soft and smooth cloth.
2. Unscrew the 3 bolts that fasten the base column to the TV by using a cross-hand screwdriver. (not supplied)
3. Pull the stand from the bottom of the TV.

TV INSTALLATION

Connect the device

Rear connections

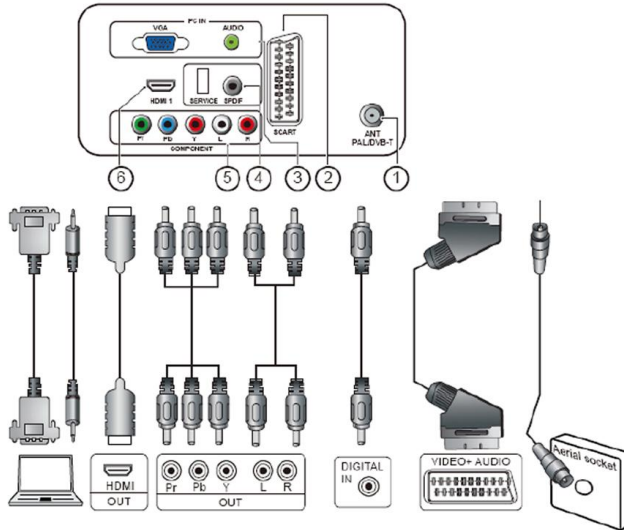

Port	Functions
1	Tuner Input Connects to TV RF signals (antenna/CATV).
2	SCART 1 Full SCART, which transmits RGB, S-Video and CVBS in, and CVBS tuner out (Analog only).
3	PC IN Connect to VGA analog signals sources. PC audio supports 3.5mm Jack.
4	SPDIF Output (Digital audio out) SPDIF is highly recommended for high quality digital sound output.
5	Component Video and L/R Audio Input The YPbPr video signal can be used if connecting through the component video port. For example Progressive Scan DVD players, Hi-scale HDTV Decoders, and satellite receivers, obtain video with maximum resolution using YPbPr and L/R audio signals.
6	HDMI 1 High Definition Multimedia Interface. Connect to devices with digitals signals and can be used with PC or HDTV video signals.

TV INSTALLATION

Connect the device

Side connections

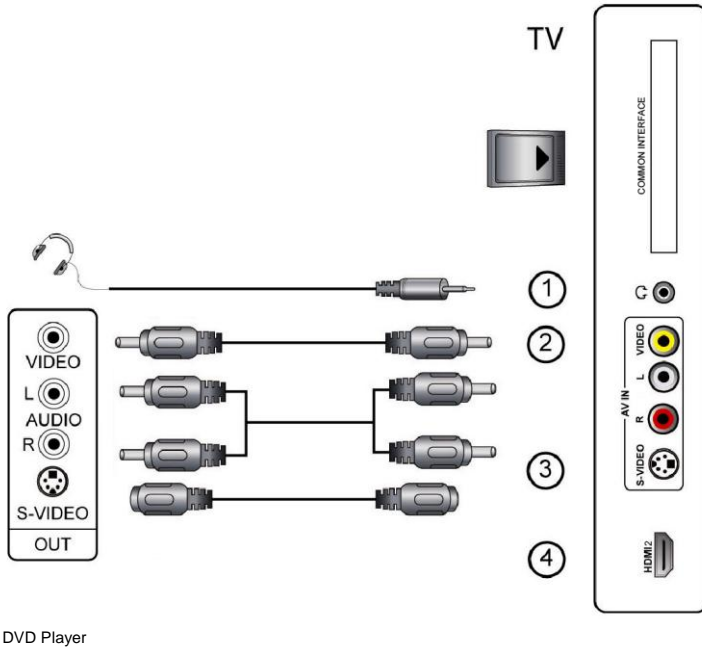

DVD Player

	Port	Functions
	COMMON INTERFACE	Function when PC Card or ExpressCard is in COMMON INTERFACE slot of the set. Please refer to your plug-in card manual for detail information.
1	Earphone Output	Connect to headphones (16Ω or 32Ω).
2	AV IN (Composite Audio/Video)	The composite audio and video provide a basic connection from the DVD player or other device.
3	S-Video	The S-Video supplies a better picture quality than RF and composite connection. Please use S-Video cable with red/white audio cable. <i>Tip: If AV and S-Video to be connected simultaneously, S-Video will has the first priority.</i>
4	HDMI 2	High Definition Multimedia Interface. Connect to devices with digital signals and can be used with PC or HDTV video signals.

TV INSTALLATION

Connect the device

Power connection

Attach the AC power cord to the LCD TV and plug into an appropriate wall outlet.

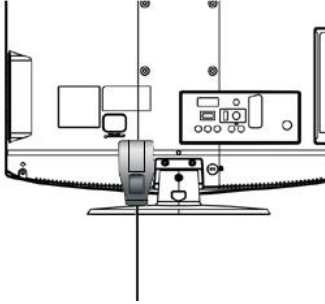

AC 100-240V 50/60Hz

Power outlets differ from region to region.

- * Do not insert the power plug in a wall socket before all connections are firm.

Turning the LCD TV on

Press the POWER button at the side of the TV or press the  button on the remote control to turn on the power or enter standby mode.

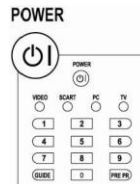
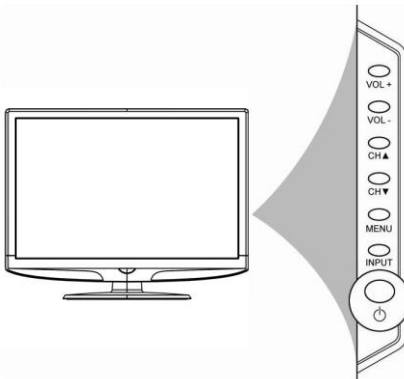

Power indicator status
Blue: Power on
Red: Standby

- * Due to unstable local voltage, there will occasionally be a delay in POWER ON when the LCD TV is switched on.

First time installation

After unpacking and plugging in your new LCD TV, please proceed with the following steps to set-up your TV. If you do not run this set-up function, your LCD TV may not operate properly.

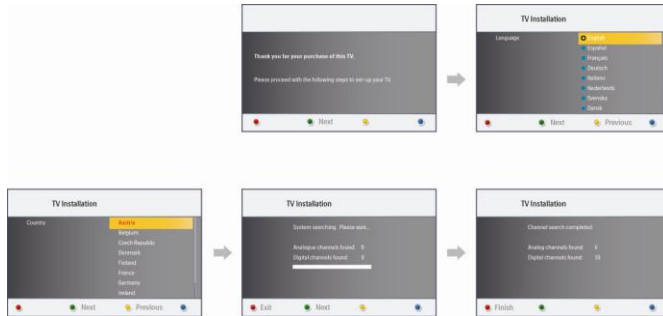

1. Press the Green button to proceed with the installation.
2. Press the \wedge or \vee buttons to select your language. And press the Green button to continue.
3. Press the \wedge or \vee buttons to select your country. And press the Green button to continue or press the Yellow button to the previous.
4. System searching may take few minutes to complete. Please wait until system searching is completed.
5. Channel search completed message may show out when system searching is finished. Press the Red button to finish system searching, then, the LCD TV will switch automatically to the first channel found.

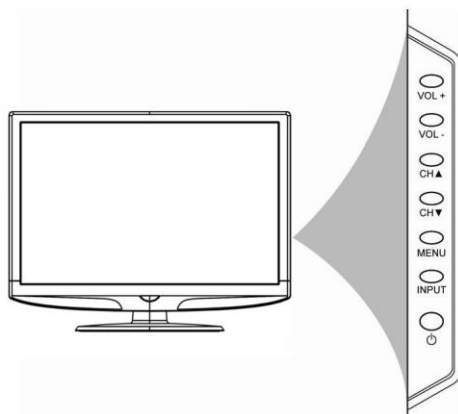

Button	Functions
POWER	Use this button to switches your LCD TV on/off.
INPUT	Use this button to toggle between video input source.
MENU	Use this button to display and adjust the features in the On-Screen-Display (OSD). Use the four arrow keys (channel and volume adjustments) to navigate the menu options.
CH ▲/▼ (FUNCTION ▲/▼)	Use these buttons to switch between programmed channels. In OSD mode, use those two buttons to switch the selection up and down.
VOL +/- (FUNCTION ▲/▼)	Use these two buttons to adjust the volume. In OSD mode, use those two bottoms to switch the selection left and right.

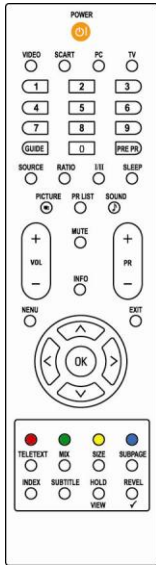

POWER

Press to turn the LCD TV on or enter standby mode.

VIDEO

Press this key you could select YPbPr, Side AV, **HDMI 1**, **HDMI 2**.

SCART

Press this key you could select **SCART**.

PC

Press to direct to the PC mode.

TV

Press to direct to the TV mode.

0-9 DIGIT BUTTONS

To select a TV channel directly.

GUIDE

Press this key to display electronic program guide in TV mode.

PRE PR

To display the previous selected TV channel.

SOURCE

Press to switch signal sources.

RATIO

Change the aspect ratio; please refer to Picture format section.

I/II

Select MONO, STEREO, DUAL 1 and DUAL 2 for ATV channel. Select Audio language for DTV channel.

SLEEP

Press to turn the LCD TV off within an amount of time. (5-180 minutes.)

PICTURE

Press to set the LCD TV to a predefined picture setting. User / Cinema / Sport / Vivid / Hi-Bright

PR LIST

Press to display a list of channels and input sources.

SOUND

Press to set the LCD TV to a predefined sound setting. Off / Rock / Pop / Live / Dance / Techno / Classic / Soft

+ VOL-

Press to adjust the volume.

+ PR -

Press to select the channel.

MUTE

Press to toggle audio on and off. You can also press **+/- VOL** to restore the previous volume level.

INFO

Press to display the current signal status, including input source/channel audio mode.

MENU

Press to activate the LCD TV OSD. Press again to exit the LCD TV OSD.

EXIT

Press to exit LCD TV OSD.

OK

Press to activate a setting.



Press **^ V <>**

to navigate and confirm your selection.

VIEW

Press to display a list of all channels marked as favorite (incl. sub channels).



Press to add or remove a channel in the favorite channels list of the TV.

COLOUR BUTTONS

When functions attached to the colour buttons are active or selected, the colour buttons are shown on screen.

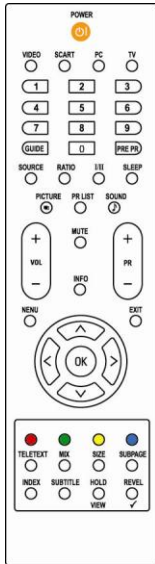

TELETEXT (Designed for Europe PAL/SECAM/DVB-T system only)

TELETEXT

Press this button to activate Teletext. Press again to turn off Teletext.

MIX

Press this button to activate Teletext with TV.

SIZE

Press this button to change the font size: Full screen, Top half and Bottom half.

SUBPAGE

Display the sub page (when available)

INDEX

Press this button to return to page 100 or the index page; and then press 0 to 9. The teletext page will be numbered and added to the page you select or the secondary item.

SUBTITLE

Press it to select the next page marked as a subtitle page and request it as the display page.

HOLD

Press this button to stop the scrolling of pages.
The text decoder stops receiving data.

REVEAL

Reveal hidden information such as answers to a quiz.

R/G/Y/B (Colour button)

Press buttons to select the pictures with various colours of text. Different channels display different functions.

Picture format

1. Press the **RATIO** button on the remote control to enter the picture format menu.
 2. Press the **▲/▼** buttons to select a picture format and press the **OK** button to confirm your choice.
- **Automatic:** The Automatic format for DTV and HDMI transport streams with AFD information, while that for ATV and SCART should be with WSS information.
 - **Panorama:** Removes the black bars on the side of 4:3 broadcasts with minimal distortion.
 - **4:3:** Displays the classic 4:3 format.
 - **Movie expand 14:9:** Scales the classic 4:3 format to 14:9.
 - **Movie expand 16:9:** Scales the classic 4:3 format to 16:9.
 - **16:9 subtitle:** Display 4:3 pictures using the full surface of the screen leaving the subtitles visible.
 - **Wide screen:** Stretches the classic 4:3 format to 16:9.

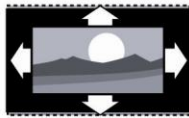

Automatic



Movie expand 14:9



Wide screen



Panorama



Movie expand 16:9



4:3



16:9 subtitle

TV menu

Using the advanced menu

OSD Settings

Press the MENU button on the side of the LCD TV or press the MENU button on the remote control.

Settings	5	Picture	9
Picture		Picture mode	
Sound		Brightness	
TV		Contrast	
Installation		Colour	
Parental		Sharpness	
		Colour temperature	
		Noise Reduction	
		Back light	
		Picture format	

Menu	Descriptions
Picture	Show more picture modes and functions based on your favourite channels and enables you to adjust the colour and brightness setup.
Sound	Provide more audio selections. You can also set the audio environment of the LCD TV.
TV	Enable you to adjust special functions for country, audio language and channel of the TV.
Installation	Enable you to adjust settings related to the installation of the TV channels and language.
Parental	Enable you to control special functions for the TV channels.

TV menu

Using the advanced menu

1. Press the MENU button on the side of the LCD TV or press the MENU button on the remote control.
2. Press the \wedge/\vee button to highlight the menu entries.
3. Press the $<$ button to enter the submenu.
4. Press the \wedge/\vee button to highlight the item to be adjusted.
5. Press the $>$ button to enter the setting.
6. Press the MENU button to quit the picture setting.

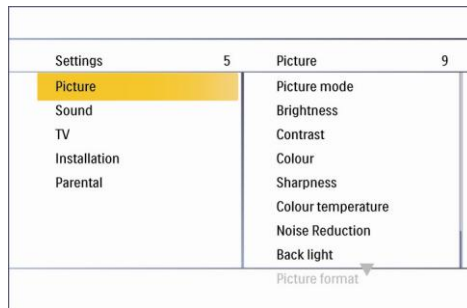

Picture

Menu	Descriptions
Picture mode	To set the LCD TV to a predefined picture settings. Use the \wedge/\vee buttons to toggle between User, Cinema, Sport, Vivid, and Hi-Bright.
Brightness	To brighten the dark parts of the picture.
Contrast	To sharpen the picture quality.
Colour	To add or reduce colour.
Sharpness	To improve detail.
Colour temperature	To choose between Normal (neutral), Warm (redder), and Cool (bluer).
Noise Reduction	To filter out and reduce the image noise and improve picture quality. Use the \wedge/\vee buttons to toggle between Off, Low, Medium, and Strong.
Back light	To make the background colour brighter or darker.
Picture format	To display a list of available display formats. Use the \wedge/\vee buttons to toggle between Automatic, Panorama, 4:3, Movie expand 14:9, Movie expand 16:9, 16:9 subtitle, and Wide screen.

Sound

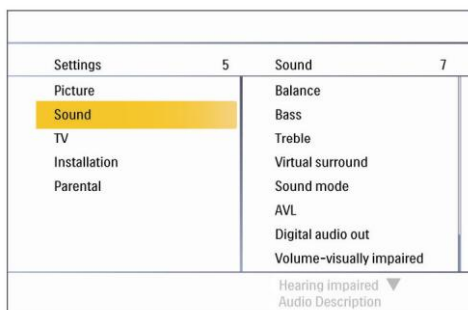

Menu	Descriptions
Balance	To adjust the balance between left/right channels.
Bass	To adjust audio setting parameters of bass.
Treble	To adjust audio setting parameters of treble.
Virtual surround	To add greater depth and dimension to the TV sound. Use the ^/∇ buttons to toggle between On or Off.
Sound mode	To set the LCD TV to a predefined sound setting. Use the ^/∇ buttons to toggle between Off, Rock, Pop, Live, Dance, Techno, Classic, and Soft.
AVL	To eliminate the volume differences between channels and programs and also reduce the dynamics of sound.
Digital audio out	To select the Digital audio out. Use the ^/∇ buttons to toggle between Off, Bit stream, and PCM. <i>Tip: When Bit stream is selected, make sure the amplifier supports digital audio.</i>
<i>The following functions are only available for digital channels with audio signals.</i>	
Volume-visually impaired	To increase or decrease the volume for the visual impaired. Use the ^/∇ buttons to adjust the volume. <i>Tip: Before you want to adjust the volume, please make sure Audio description is On.</i>
Hearing impaired	To transmit audio-frequency for the hearing impaired. Use the ^/∇ buttons to toggle between On or Off.
Audio description	To enable or disable the volume-visually impaired function. Use the ^/∇ buttons to toggle between On or Off.

TV

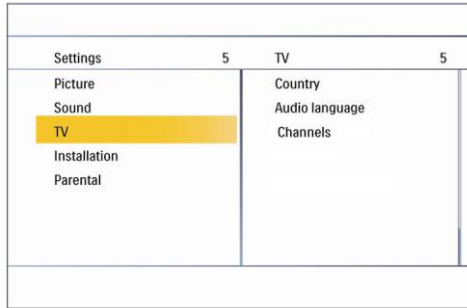

Menu	Descriptions
Country	To select the relevant country. This is the country you are in, or the country whose channels you want to receive if you live near its borders.
Audio language	To display a dialogue enabling the preferred language to be set. This is the language to be used for digital channels if it is available.
Channels	Use the \wedge/\vee buttons to toggle between Channel scan, Update scan, Analog manual store, Channel skip, Channel sort, and Channel name edit. Please refer to the next page for further instructions.

TV/Channels

Menu	Descriptions
Channels	<ul style="list-style-type: none"> • Channel scan <ol style="list-style-type: none"> 1. Use the ▲▼ buttons to select Channel scan in the Channels menu. 2. Press the ⏏ button to enter it and press the OK button to start searching the local program automatically. • Update scan <ol style="list-style-type: none"> 1. Use the ▲▼ buttons to select Channel scan in the Channels menu. 2. Press the > button to enter it and press the OK button to start searching the local program automatically. • Analog manual store <ol style="list-style-type: none"> 1. Use the ▲▼ buttons to select Channel scan in the Channels menu. 2. Press the > button to enter it and press the ▲▼ buttons to toggle between Search or Fine tune. <ul style="list-style-type: none"> ■ Search: to start manual scanning from the specified frequency. ■ Fine tune: to fine tune the program. • Channel skip <ol style="list-style-type: none"> 1. Use the ▲▼ buttons to select Channel skip in the Channels menu. 2. Press the > button to enter it and press the ▲▼ buttons to highlight the program you want to skip and press the OK button to confirm. <p><i>Tip: The skipped program may not be found by pressing ▲▼ buttons but can be access by pressing number buttons directly.</i></p> <ul style="list-style-type: none"> ■ <input type="checkbox"/> Programs with this are active ■ <input checked="" type="checkbox"/> Programs with this are skipped

TV menu

Using the advanced menu

TV/Channels

Menu	Descriptions
Channels	<ul style="list-style-type: none"> Channel sort <ol style="list-style-type: none"> Use the ^/∨ buttons to select Channel sort in the Channels menu. Press the > button to enter it and use the ^/∨ buttons to highlight a program you want to sort and press the OK button to select. Use the ^/∨ buttons to highlight the second program you want to exchange with the first selected on and press the OK button to switch. Channel name edit <ol style="list-style-type: none"> Use the ^/∨ buttons to select Channel name edit in the Channels menu. Press the > button to enter it and press the ^/∨ buttons to highlight the program you want to edit. Press the Red button to start editing program name. Use the ^/∨ buttons to edit name and use the > button to move to the next character. Please refer to below table for available characters. Press the Green button to confirm.
	<p><i>Tip: When functions attached to the colour buttons are active or selected, the colour buttons are shown on screen.</i></p>



Available characters

	_	-	.	@	0	1	2	3	4
5	6	7	8	9	A	B	C	D	E
F	G	H	I	J	K	L	M	N	O
P	Q	R	S	T	U	V	W	X	Y
Z	a	b	c	d	e	f	g	h	i
j	k	l	m	n	o	p	q	r	s
t	u	v	w	x	y	z			

Available characters

0	.	@							
1			-	1					
2	A	B	C	a	b	c	2		
3	D	E	F	d	e	f	3		
4	G	H	I	g	H	i	4		
5	J	K	L	j	k	l	5		
6	M	N	O	m	n	o	6		
7	P	Q	R	S	p	q	r	s	7
8	T	U	V	t	u	v	8		
9	W	X	Y	Z	w	x	y	z	9

Installation

Settings	5	Installation	7
Picture		Language	
Sound		Source	
TV		Time setup	
Installation		Subtitle	
Parental		Teletext	
		Current software info	
		Reset AV settings	

Menu	Descriptions
Language	To choose of languages in your interface.
Source	To identify the accessory devices you have connected to the external inputs/outputs.
Time setup	<p>Use the ^/v buttons to toggle between :</p> <ul style="list-style-type: none"> • Time zone: to select the time zone you are in. • Time: to set the time and date or make it auto synchronization. <p><i>Tip: Before you want to set the time and date by your own, please make sure Auto synchronization is Off.</i></p> <ul style="list-style-type: none"> • Sleep timer: to set the TV to turn itself off within a certain time.
Subtitle	<p>Use the ^/v buttons to toggle between :</p> <ul style="list-style-type: none"> • Analog subtitle: to display the transmitted subtitle on the screen. This text can either be permanently displayed (assuming that the service is available in the broadcast) or only when mute is active. • Digital subtitle language: to select the transmitted language on the screen. • Subtitle type: to choose the normal type or hearing impaired type of subtitle.

Installation

Settings	5	Installation	7
Picture		Language	
Sound		Source	
TV		Time setup	
Installation		Subtitle	
Parental		Teletext	
		Current software info	
		Reset AV settings	

Menu	Descriptions
Teletext	Use the ▲▼ buttons to toggle between : <ul style="list-style-type: none"> • Digital teletext language: to select the transmitted language of teletext on the screen. • Decoding page language: to decode the teletext language on regional location.
Current software info	This menu appears with your TV software information.
Reset AV settings	To reset most of the picture and sound settings to their default factory levels.

Parental

Settings	5	Parental	3
Picture		Channel lock	
Sound		Program lock	
TV		Set PIN	
Installation			
Parental			

Menu	Descriptions
Channel lock	To lock a certain TV channel or external source completely.
Program lock	To control access programs based on their age ratings. All settings apply to digital channels.
Set PIN	<p>To change your access code or overwriting it. If no PIN-code exists, the menu item is set to Set PIN. Please follow the instructions to set it. If a PIN-code has been entered previously, the menu item is set to Change PIN. Please follow the instructions to change it.</p> <p>All member combinations from 0000 to 9999 are valid.</p> <p><i>Tip: Remember that 0711 is the default Change PIN code. If your access code has been changed or you have forgotten the code, you can always get in by inputting the default code.</i></p>

Other information**Troubleshooting**

The following table contains the common problems and the solutions to these problems. Please check this list before you contact technicians.

Problems	Solutions
No picture	<ol style="list-style-type: none">1. Connect power cord correctly.2. Turn on power.3. Connect signal cable correctly.4. Press any button on the LCD TV.
Abnormal colours	Connect signal cable correctly.
Twisted picture	<ol style="list-style-type: none">1. Connect signal cable correctly.2. Please use compatible signal.
Picture too dark	Adjust brightness and contrast.
Audio only, no images	<ol style="list-style-type: none">1. Please check if input signal is connected correctly.2. TV-RF signal must not be lower than 50dB.
Picture only, no audio	<ol style="list-style-type: none">1. Connect signal cable correctly.2. Adjust volume to proper level.3. Connect audio signal cable correctly.4. TV-RF signal must not be lower than 50dB.
Cannot use remote control	<ol style="list-style-type: none">1. Please change battery.2. Turn off power for 10 seconds; and then restart power.
Cannot receive sufficient channels through antenna	Please use the Channel scan function to increase the number of channels not included in memory.
No colours	Please adjust the colour setup.
Blinking picture accompanied by ghost image	<ol style="list-style-type: none">1. Check the connection of antenna/signal cable.2. Check if channel is in play mode.3. Press signal source and change input mode.
Broken lines or segments	Adjust antenna. Keep the TV away from noise sources, such as automobiles, neon lights, and hair dryers.
Certain TV channels are blocked (Hope to acquire some channels)	Please use the Update scan method to add the channels not included in memory.
Overlapping images or ghost images	Please use multi-directional outdoor antenna. (If your TV is subject to the influence of nearby mountains or buildings).
Cannot use a function	If the item you choose turns gray, that item cannot be selected.
Cannot receive programs	Please use the Update scan method to add the channels not included in memory.

Audio / Video Inputs

Located on the rear and the front of the receiver these connectors (RCA phono type plug) are used for the input of audio and video signals. Designed for use with VCRs (or other accessories) in order to receive higher picture resolution and offer sound connection options.

S-Video Input

Allows direct connection of high-resolution video sources, such as a Super VHS videocassette recorder, Laser Disc player, etc. Provides improved picture resolution, sharpness, and clarity.

Menu

An on-screen listing of feature controls shown on the TV screen that are made available for user adjustments.

Programming

The procedure of adding or deleting channel numbers into the TV's memory.

In this way the TV 'remembers' only the locally available or desired channel numbers and skips over any unwanted channel numbers.

Virtual Surround

Virtual surround audio solutions provide greater listening enjoyment for compressed Internet radio or clear Speech that enhances the users experience and overall satisfaction.

RF

Radio Frequency or modulated signal design used as the carrier for television broadcasts.

Sleep Timer

Function with which you can set a time period after which the TV should turn itself off.

Other information
Specifications

Model No.	L19W981	L22W981	L26W981
DISPLAY			
Aspect Ratio	16:10	16:10	16:9
Resolution	1440 x 900	1680 x 1050	1366 x 768
OSD Language	English, German, French, Italian, Spanish, Portuguese, Dutch, Danish, Finnish, Swedish, Norwegian, Polish, Russian, Greek		
ENHANCEMENT			
Sound Output (RMS Watts)	3W	3W	5W
Sound Mode	Rock, Pop, Live, Dance, Techno, Classic, Soft		
Picture Formats	Automatic, Panorama, 4:3, Movie expand 14:9, Movie expand 16:9, 16:9 subtitle, Wide screen		
Picture Mode	User, Cinema, Sport, Vivid, Hi-Bright		
CONNECTIONS			
Rear Connectors	Tuner input (75Ω) SCART 1 PC IN :VGA and Audio cable Component Video and L/R Audio input SPDIF Output (Digital audio out) HDMI 1		
Side Connectors	Earphone Output AV In (Composite Audio/ Video) S-Video HDMI 2 COMMON INTERFACE		
WEIGHT & DIMENSION			
Product Dimension (W x D x H)	446 mm 359 mm 145 mm	512 mm 400 mm 145 mm	652 mm 480 mm 220mm
Net Weight	3.9 kg	5.0 kg	8.8 kg
POWER			
Operation (Max.)	< 50W	< 55 W	< 110 W
Standby	< 1W		
Mains Power	AC100-240V 1.5A 60-50Hz	AC100-240 V 1.5A 60-50Hz	AC100-240V 1.5A 60-50Hz