

SCART DVB-T User manual

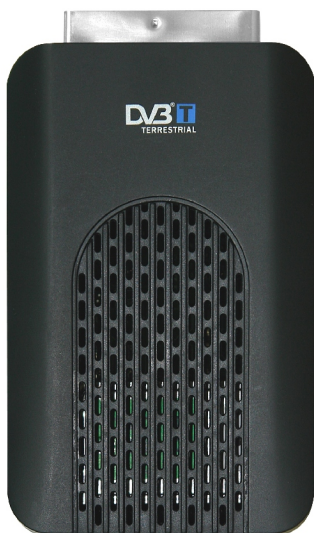

Safety Instructions

- Always read the safety instructions carefully
- Keep this User's Manual for future reference
- Keep this equipment away from humidity
- Lay this equipment on a reliable flat surface before setting it up.
Do not stand it on soft furnishings.
- If any of the following situation arises, get the equipment checked by a service technician:
 - ✘ The equipment has been exposed to moisture.
 - ✘ The equipment has been dropped and damaged.
 - ✘ The equipment has obvious sign of breakage.
 - ✘ The equipment has not been working well or you cannot get it work according to User's Manual.

Warning

- To prevent the risk of electric shock, do not open the cover or the back of the receiver.
- Do not block the ventilation holes of the device. Leave appropriate gap above and around it to allow for adequate ventilation.
- Do not place the device in an unventilated cabinet or on top of a unit which emits heat.
- To reduce the risk of fire or electric shock, do not expose this apparatus to rain or moisture. The apparatus shall not be exposed to dripping or splashing and that no objects filled with liquids, such as vases, shall not be placed on apparatus.
- The mains plug is used as disconnect device, the disconnect device shall remain readily operable.

Copyright Statement

No part of this publication may be reproduced in any form by any means without the prior written permission. Other trademarks or brand names mentioned herein are trademarks or registered trademarks of their respective companies.

Disclaimer

Information in this document is subject to change without notice. The manufacturer does not make any representations or warranties (implied or otherwise) regarding the accuracy and completeness of this document and shall in no event be liable for any loss of profit or any commercial damage, including but not limited to special, incidental, consequential, or other damage.

Table of Contents

Introduction	1
Front and Rear Panel.....	2
Remote Controller	3
Connections.....	5
First Time Installation.....	7
Basic Operations	9
Using the On-Screen Setup Menu.....	13
Troubleshooting	25
Specifications.....	26

Introduction

This DVB-T TV Receiver is a Free-To-Air digital terrestrial receiver, allowing you to access free-to-air digital terrestrial TV channels and radio broadcasts on your TV set. Its digital reception covers VHF & UHF band. Compared with the analog TV programs, digital TV programs eliminate the noise and interference but offer high quality video and audio. An on-screen initial installation guide is provided so that you can easily start to enjoy watching the programs. In addition, a fully featured remote controller is included that offers you access to every feature with a simple press of a button.

Main Features

- Full comply with European DVB-T standard
- Full MPEG2 ISO/IEC 13818 transport stream compliant audio/video decoding
- Bandwidth of 6/7/8MHz supported
- COFDM demodulator
- Automatic/manual channel search
- Channel edit, moving and deletion
- Parental lock control
- NTSC/PAL converting automatically and manually
- EPG (Electronic Program Guide) and Teletext function
- Multiple-language OSD
- Supports multi-subtitle
- SDTV only
- Full function remote control

Package Contents

Before installation, please check the items of the package.

The package should contain the following items:

~ DVB-T TV Receiver	x1
~ Remote Controller	x1
~ AAA Battery for the remote controller	x2
~ User's Manual	x1
~ Scart connect cable	x1
~ DC adapter	x1
~ Remote receiver	x1

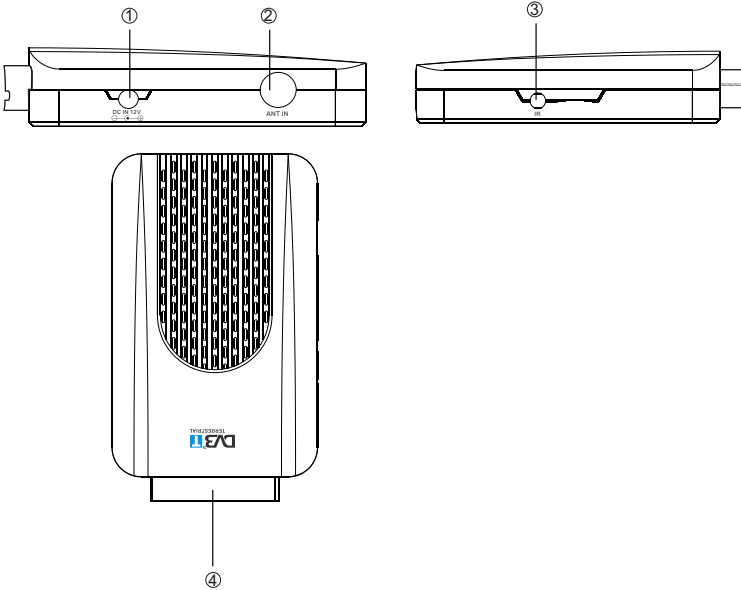

- ① DC IN 12V: Used to connect the 12V DC adapter.
- ② Antenna in: Used to connect the antenna to receive the signal.
- ③ Remote control: Used to connect the remote control line.
- ④ Scart interface: connect to the TV'S scart interface directly or though a scart cable if it is necessary.

Remote Controller

Remote Key Function:

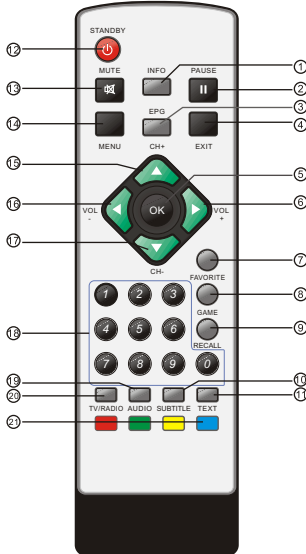

1. **INFO:** Used to display information about the channel being viewed or further information about the program when in small EPG screen.
2. **PAUSE:** Used to pause or playback the program being viewed.
3. **EPG:** Used to display information about the program being viewed and what's on next.
4. **EXIT:** Used to return to the previous screen or menu.
5. **OK:** Used to confirm a selection within a menu.
6. **VOL+:** Used to move around the menu screens or changing the volume in non-menu state.
7. **FAVORITE:** Used to access your favourite channels.
8. **GAME:** Used to select 4 built-in mini games: Mine, Tetris, Gomoku, Calendar.
9. **RECALL:** Used to switch between the last two viewed channels.
10. **SUBTITLE:** Used to switch between different subtitles that are broadcasted.
11. **TEXT:** Used to open teletext/OSD display if teletext available in the broadcasted stream.
12. **STANDBY:** Used to switch the set top box to on and off.
13. **MUTE:** Used to turn the sound on or off.
14. **MENU:** Used to open the main menu window.
15. **CH+:** Used to move around the menu screens or selecting the channels in non-menu state.
16. **VOL-:** Used to move around the menu screens or changing the volume in non-menu state.
17. **CH-:** Used to move around the menu screens or selecting the channels in non-menu state.
18. **NUMBER KEYS:** Used to select channel numbers or input numbers in menus.
19. **AUDIO:** Used to set the sound output, the available settings are STEREO, LEFT, RIGHT, MONO.
20. **TV/RADIO:** Used to switch between TV channels and Radio stations.
21. **COLOR KEYS (RED/GREEN/YELLOW/BLUE):** Used to operate different functions in TEXT screen or other menus.

Note: SUBTITLE/TEXT/LANGUAGE may not be available for all channels

Installing the Batteries

Remove the battery cover from the remote control and put 2XAAA size batteries inside the compartment.

The diagram inside the battery compartment shows the correct way to install the batteries.

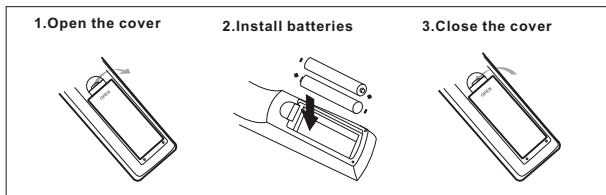

Using the Remote Control

To use the remote control, point it towards the front of the digital set top box.

The remote control has a range of up to 7 metres from the set top box at an angle of up to 60 degrees.

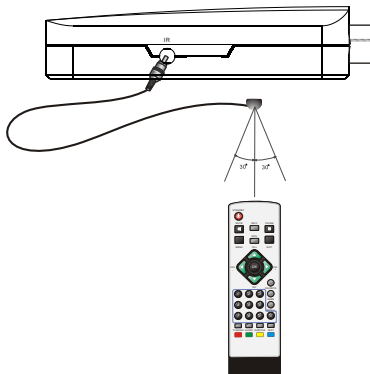

The remote control will not operate if its path is blocked.



Sunlight or very bright light will decrease the sensitivity of the remote control.

Connections

Caution: Make sure to check the voltage specification of the wall outlet is the same rating with the receiver. To prevent the risk of electric shock, do not open the cover or the back of the receiver.

Connecting to TV

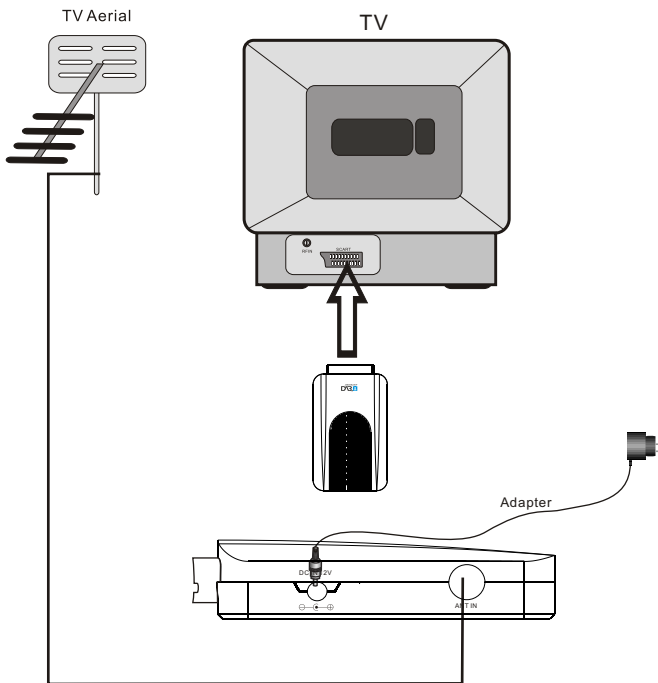

Connecting to TV

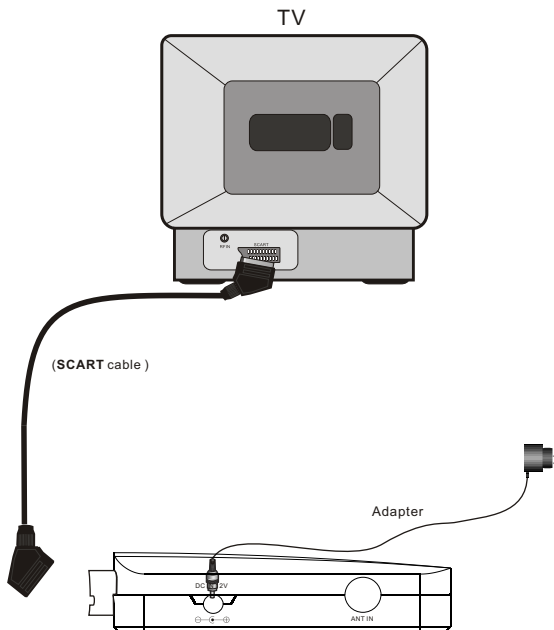

Note: When connecting the receiver to other equipment, e.g., TV, VCR and amplifier, make sure to refer to relevant user manual for instruction. Also, make sure you disconnect all the equipments from the mains supply before the connection.

First Time Installation

After all the connections have been made properly, switch on your TV. Make sure the receiver is connected to the mains and insert the adapter to the receiver. If you are using the receiver for the first time, a **First Time Installation** menu will be displayed to guide you through the initial setup. Use the remote controller to finish the setup.

1. At the **First time installation** menu, select **YES** and press **OK** on the remote controller to proceed.



2. Enter your regional settings, include your Region, OSD Language, Time Zone and Antenna Power. Then select **NEXT** to proceed.



Note: Make sure to select the region you are located since the receiver will scan the channels based on the bandwidth of the region you selected. If your region is not on the list, you are recommended to conduct a manual search. Refer to " Manual Search " on page 16 for details.

3. Select **Yes** to start the automatic channel search.

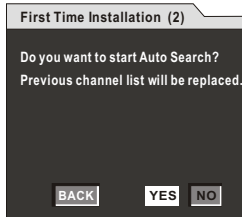

4. Wait to complete the scanning.
In case you want to stop the scanning, press the **EXIT** key.
The channels already found will still be stored.

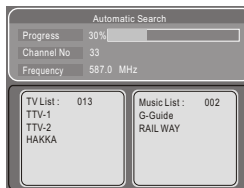

5. When finished, all active channels found will be stored automatically. The last found channel will be played.

Now you are ready to watch digital terrestrial TV channels and radio broadcasts.

In case you skip the **First Time Installation** screen, you can still specify your **Regional Setting** and **Program Search** via the on-screen setup menu.

The **Regional Setting** menu can be accessed via **Main Menu > System Settings > Regional Setting**. Refer to "Regional Setting" on page 20 for details.

The **Program Search** menu can be accessed via **Main Menu > Program Search > Automatic Search / Manual Search**. Refer to "Automatic Search" on page 15 for details.

Basic Operations

Once program search is completed, you can start to watch digital terrestrial TV channels and radiobroadcasts. Some typical operations are given in this chapter.

Switching On and Off

Whenever you are not using the receiver, press the **Standby** key on remote control.

Changing Channels

To switch between different channels, you can:

- Press **OK** to display the channel list and **UP/DOWN** to select a desired channel.



- Use the numeric keys to select a channel number.
 - Use the **RECALL** key to return to the previous viewed channel.
- Whenever you change a channel, a banner appears at the bottom of the screen displaying the basic information on the current channel.

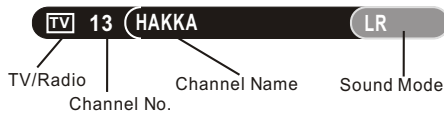

Adjusting the Volume

Press the **VOL+** / **VOL-** key to adjust the volume.



Watching Favorite List

You can press **FAVORITE** to watch your preset favorite channels. To create your favorite list, go to **Main Menu > Program List**. Refer to "Creating Favorite Channel Groups" on page 13 for detailed information.

Displaying information

To display the detailed information of the current channel, press the **INFO** key.

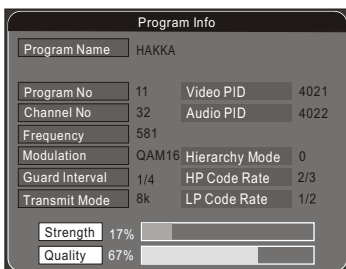

Choosing Subtitle

You can press the **SUBTITLE** key to select or close subtitles on the screen. The available subtitles depend on the broadcaster.



Freezing

When watching a channel, you can freeze the current screen by pressing the **PAUSE** key. Pressing it again disables the freeze function.

Displaying EPG

To view the EPG (electronic program guide) provided by the content provider:

1. Press the **EPG** key and then use the **Up / Down** key highlight a desired channel to preview the EPG. To view today's complete EPG, press the **Right** key.



2. When today's complete EPG is displayed, use the **Up / Down** key to scroll along the EPG. To view the EPG of next/previous day, press the **UP / Down** key continuously. To see the highlighted EPG details, press the **Right** key.



3. The detailed EPG screen will show as below if pressed the **Right** key.



4. To exit the detailed EPG screen, press the **Left** key.

Displaying Text

Press the **TEXT** key to open a teletext page (if teletext is transmitted).

Press **TEXT** key again to close it.

Selecting Sound Mode

To switch the sound mode between LL (left), RR (right) and LR (stereo), press the **Audio** key.

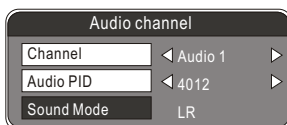

Using the On-Screen Setup Menu

The receiver features an on-screen menu providing access to a variety of setup and management controls.

Use the remote controller to navigate through the menu and activate required settings.

Managing Program List

Main Menu > Program List > TV / Radio Program List

All active channels are listed in the **Program List**, allowing you to make your own favorite channel group, move, delete or sort channels.

Creating Favorite Channel Groups

This feature allows you to group your favorite channels. To create your favorite groups:

1. Select the channel which you would like to add to the group and go to the **Favor** column.
2. When the **Favor** column of the desired channel is highlighted, one red heart symbol would appear after pressed the **OK** key. Pressing the **OK** key again will un-select the channel from the favorite group.
3. Once your favorite group is created, you can press the **FAVORITE** keys to quickly access your favorite channels.

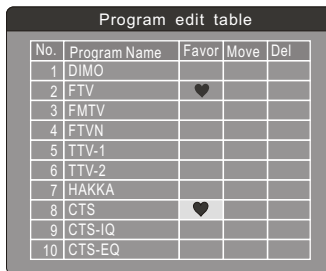

No.	Program Name	Favor	Move	Del
1	DIMO			
2	FTV			
3	FMTV	♥		
4	FTVN			
5	TTV-1			
6	TTV-2			
7	HAKKA			
8	CTS	♥		
9	CTS-IQ			
10	CTS-EQ			

Moving a Channel

1. Select the channel which you like to move and go to the **Move** column.
2. Press **OK** and a ↓ ↑ symbol will be displayed.
3. Use the **Up / Down** key to move the channel to a desired position.

No.	Program Name	Favor	Move	Del
1	DIMO			
2	FTV			
3	FMTV			
4	FTVN			
5	TTV-1		↑↓	
6	TTV-2			
7	HAKKA			
8	CTS			
9	CTS-IQ			
10	CTS-EQ			

Deleting a Channel

1. Select the channel which you like to delete and go to the **Del** column.
2. Press **OK** and an **X** symbol will be displayed. Repeat this step in the channel to be deleted.
3. Press **EXIT** or **MENU** and the marked channel will be deleted.

No.	Program Name	Favor	Move	Del
1	DIMO			X
2	FTV			
3	FMTV			X
4	FTVN			
5	TTV-1			
6	TTV-2			
7	HAKKA			
8	CTS			
9	CTS-IQ			
10	CTS-EQ			

Sorting Channels

1. Go to **Main Menu > Program List > Sort**.
2. You can sort the channels by the channel name, service ID or channel number. Select one method as required.

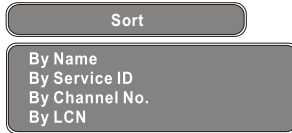

3. Press **MENU** or **EXIT** to return the program list. The list is now sorted by the specified order.

Program Search Automatic Search

1. Enter the **Automatic Search** menu via **Main Menu > Program Search > Automatic Search**.
2. Select **OK** to start auto search.

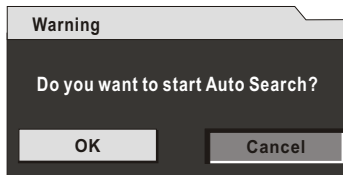

3. Select whether to erase your previous channel list as required.

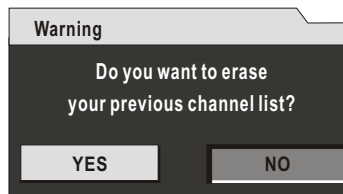

4. Wait to complete the scanning.
In case you want to stop the scanning, press the **EXIT** key.
The channels already found will still be stored.

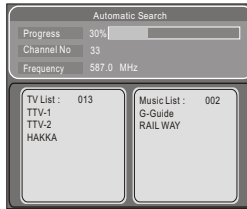

5. When finished, the last found channel will be played.

Manual Search

If any channel is missing after auto search, or you want to add newly launched channels, you can use **Manual Search** to scan the desired channels. To manually search the target channel, you must know its parameters, e.g., the channel number. After the channel is found, it is appended to the current channel list.

1. Enter the **Manual Search** menu via **Main Menu > Program Search > Manual Search**.
2. Specify the appropriate channel number in the **Channel No** field by pressing **Right/Left** or the numeric keys. Upon your selection, the frequency and bandwidth values are changed accordingly.
3. Select **OK** to start manual search.

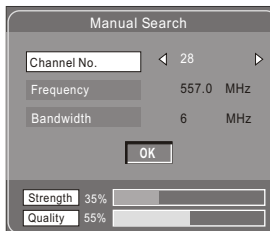

4. If no signal is found, a message indicating no signal will appear. Otherwise scanned channel will be saved and appended to the current channel list.

Parental Control

This feature allows you to prevent children or unauthorized people from watching channels.

1. Go to **Main Menu > Parental Control**. First, you will need to enter PIN as prompted to use the parental control menu. (The default PIN is 6666.)

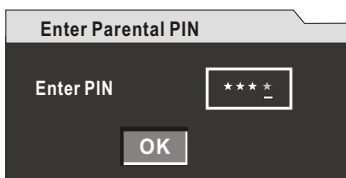

2. After correct PIN input, the following options are provided:

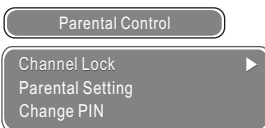

Channel Lock: Allows you to activate or de-activate the overall parental control. When set to **YES**, all the channels with locking settings will be belocked.



Parental Setting: In the channel list, select the channel you want to lock and then press **OK**. A padlock symbol will be displayed. To remove the lock, press **OK** again.

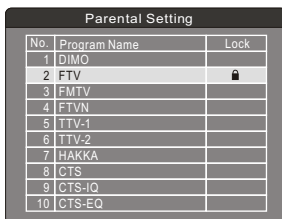

No.	Program Name	Lock
1	DIMO	
2	FTV	🔒
3	FMTV	
4	FTVN	
5	TTV-1	
6	TTV-2	
7	HAKKA	
8	CTS	
9	CTS-IQ	
10	CTS-EQ	

Change PIN: Allows you to change the PIN. A PIN can be composed of 1 to 4 digits. To change the PIN, enter the old, new PIN in the provided fields. After pressing **OK**, a message indicating **PIN Code Changed** will appear.

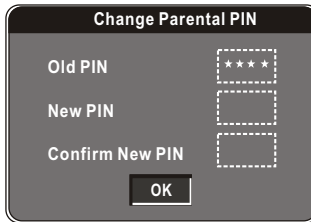

The image shows a dialog box titled "Change Parental PIN". It contains three input fields: "Old PIN" with four asterisks, "New PIN" with four empty boxes, and "Confirm New PIN" with four empty boxes. Below the fields is an "OK" button.

Note: To activate the parental control feature, **Channel Lock** must be set to **YES**. If you want to lock particular channels while keeping other channels unlocked, use **Parental Setting** table to make the settings.

Watching Locked Channels

Once a channel is locked, whenever one want to watch the locked channel, correct PIN must be entered.

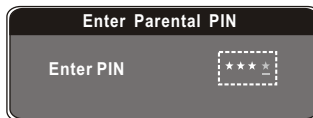

The image shows a dialog box titled "Enter Parental PIN". It contains one input field labeled "Enter PIN" with four asterisks.

System Settings

TV Standard

This option allows you to select your TV system among **PAL**, **NTSC** and **Auto**.

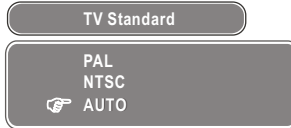

Display Type

This option allows you to select the aspect ratio of the video output. If you are using normal 4:3 TV, it is OK to view the regular 4:3 content being broadcasted. But occasionally broadcasters transmit widescreen content; in this situation, you can choose how to display it in a conventional TV set.

- 4:3 LB (Letterbox)**
For conventional 4:3 TV. The full width of a widescreen content is displayed on a normal TV with black bars above and below the picture.



- 4:3 PS (Pan & Scan)** For conventional 4:3 TV. It crops the left and right edges of a widescreen content to fit a normal TV.



- 16:9** - If you are using a wide screen TV, select this option.

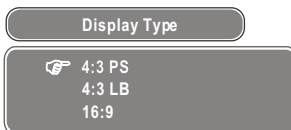

Video Output

Set the videomode as **CVBS** or **RGB**.

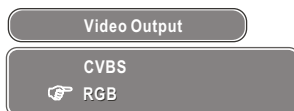

Antenna Power

The default setting is **OFF**. Set this option to **ON** if this receiver box is connected to an external active antenna that amplifies the received signal. This receiver box can supply 5VDC at 50mA maximum.

Caution: If you are using a normal passive antenna, make sure to set this setting to **OFF** .

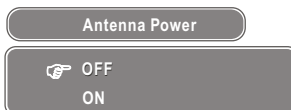

Regional Setting

Region: Select the region or country you are located. Depending on the country you select, the on-screen-display language and time zone settings change accordingly.

OSD Language: Select the on-screen-display language as required.

Time Zone: Select an appropriate time zone to display the local time correctly. Both EPG and system schedule need a correct time zone setting.

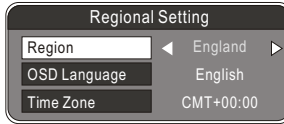

Language

OSD Language: Select the on-screen-display language as required.

1st /2nd Audio Language: This option allows you to select your first and second choice for the audio language. If neither of your selected language is available on the program transmitted, the main language of the program will be used. You can alternatively press the **AUDIO** key to use another available language.

Subtitle Language: Allows you to select the subtitle language. If your selected language is not available on the program transmitted, the main language of the program will be used. You can also select **OFF** to close the subtitle on the screen.



Time Setting

Select an appropriate time zone to display the local time correctly. Both EPG and system schedule need a correct time zone setting.

GMT usage: Allows you to enable/disable Greenwich Mean Time (GMT) usage.

If you know the GMT time zone of your location, set **GMT usage** to **ON** and select an appropriate time zone. If you prefer to set the time manually, select **OFF** in **GMT usage** item and then manually select the date and time.

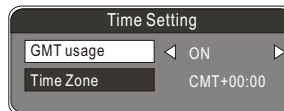

System Schedule

This feature allows the receiver to automatically switch on and tune to a pre-specified channel for a pre-set length of time. You can use this feature to schedule recording if your receiver is connected to a VCR or recorder or as reminders of certain programs. Up to 10 tasks can be scheduled.

1. In the **Schedule** pane, use the **Up / Down** key to select a task and use **Right / Left** key to switch between **Inactive** and **Active**.
2. Press **OK** to enter the **Detail** pane.
3. Enter the following settings as required. Use the **Up / Down** key to move between setting items, the **Right / Left** key to switch between available selections and numeric keys to enter numeric value.

Mode: You can repeat the task by setting the frequency as **Once**, **Daily** or **Weekly**. Or you can select **Stop** to disable the task.

Start and End Time: Enter the start and end time that automatically turns on and off the receiver.

Channel Type: Select TV or radio channel as required.

Channel No: Select the channel to be played at scheduled time.

4. When the setting is done, press **MENU** or **EXIT** to save the changes.

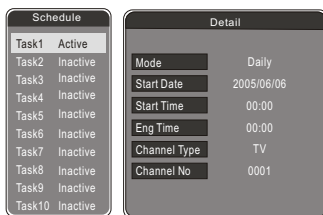

Game

This option includes 4 built-in mini games: **Mine**, **Tetris**, **Gomoku**, **Calendar**.

Accessory

System Information

This option allows you to view the current system information.

System Information

Version: v3.03 SCTV_LG_9013_0.1.7.1
Date:MM/DD/YYYY

Factory Default

This option allows you to resume factory defaults.

1. To reset defaults, select **OK**.

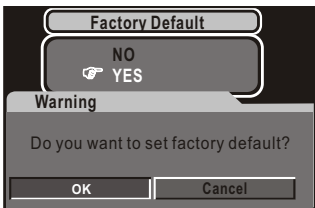

2. All programs you have searched will be erased and all parameters, e.g., the regional settings, languages and favorite lists, will return to the factory default.
3. After restoring defaults, a **First Time Installation** screen appears asking if you would like to conduct an automatic scan search.

System Update

Whenever a software update is available, the receiver can be upgraded for new features.

System Update

Status	Initializing
Transmission	000%
Burn	000%

Press Any Key to Exit.

Personal Style

This option allows you to customize the menu settings.

You can set the **Menu Color**, **Transparency level**, **Border Pattern** and **Entry Animation** as preferred.



Troubleshooting

If you experience problems with this receiver or its installation, in the first instance please read carefully the relevant sections of this User Manual and this Troubleshooting section.

Problem	Possible cause	What to do
Standby light not lit	Mains lead unplugged	Check mains lead
No signal found	Aerial is disconnected	Check aerial lead
	Aerial is damaged/misaligned	Check aerial
	Out of digital signal area	Check with dealer
No picture or sound	The Scart interface not connect hard	Reinsert the Scart STB to the TV set
	Tuned to digital teletext channel	Retune to another channel
Mosaic blocks in picture or picture freezes	Aerial may not be compatible	Check aerial
Scrambled channel message	Channel is scrambled	Select an alternative channel
Forgotten channel lock code		Re-install channels to cancel channel lock
No response to remote control	Receiver off	Plug in and turn on receiver
	Handset not aimed correctly	Aim handset at front panel
	Front panel obstructed	Check for obstructions
	Remote control batteries are inserted incorrectly	Check batteries direction
	Handset batteries exhausted	Replace remote control batteries
After moving the receiver to another room, find can't receive the digital reception	The aerial feed may come through a distribution system which may reduce the digital signal now received by the receiver	Try a direct feed from the antenna

Specifications

Item	Specification	
Tuner	Frequency Range	VHF: 174MHz to 230MHz UHF: 470MHz to 866MHz
	Input Impedance	75 Ohms unbalanced
	Signal Input Level	-78 ~ -25 dbm
	Bandwidth	7 / 8 MHz
Demodulation	Demodulator	COFDM
	OFDM Modulation	2K, 8K FFT, SFN and MFN
	Packet Carries	2K/8K
	Guard Interval	1/4, 1/8, 1/16, 1/32
Connectors	RF IN	IEC 169-2 female connector
	TV SCART	Composite video(CVBS), RGB, audio L/R
Power	Input	100-240V~ 50/60Hz
	Consumption	10 W max.
Display	Decoder Module	PAL, NTSC
	Resolution	720 x 576(PAL); 720 x 480(NTSC).
	Aspect Ratio	4:3 (Letterbox, Pan & Scan),16:9
Decoding	Video	MPEG2 Transport <u>MP@ML</u>
	Audio	MPEG2 Audio Layer I&II
Others	Compliance	ETSI EN 300 744 DVB-T Compliance
	Sound Mode	Right, Left, Stereo

*Specifications are subject to change without further notice.



■ This symbol on the product or in the instructions means that your electrical and electronic equipment should be disposed at the end of life separately from your household waste. There are separate collection systems for recycling in the EU. For more information, please contact the local authority or your retailer where you purchased the product.