

# AKURA

**Model : ABLDVD3220W-HDID  
32" Digital LCD TV**

**with DVD DVBT "Freeview" HDMI**



## **USER'S MANUAL**

**HDMI**<sup>™</sup>  
HIGH-DEFINITION MULTIMEDIA INTERFACE

**HD**  
ready

**DVD**  
VIDEO<sup>™</sup>

**DVB**<sup>®</sup>

**Customer Helpline: 01422 26 33 13**

**Website: [www.ekey.co.uk](http://www.ekey.co.uk)**

## CONTENTS

---

<b>1</b>	<b>SAFETY INFORMATION</b>	<b>3</b>
<b>2</b>	<b>SAFETY PRECAUTIONS</b>	<b>4</b>
<b>3</b>	<b>ACCESSORIES</b>	<b>5</b>
<b>4</b>	<b>FRONT CONTROLS AND REAR CONNECTIONS</b>	<b>6</b>
<b>5</b>	<b>TV INSTALLATION CONNECTIONS</b>	<b>7</b>
	MAINS LEAD connection	7
	ANTENNA connection	7
	HDMI connection	8
	PC connection	8
	S-VIDEO connection	9
	Y,Pb,Pr connection	9
	SCART connection	10
	AV Connection	10
	CAM (Conditional Access Module)	11
	SERVICE PORT	35
<b>6</b>	<b>REMOTE CONTROL</b>	<b>12</b>
	REMOTE CONTROL INSTRUCTIONS in TV mode	12
	REMOTE CONTROL INSTRUCTIONS in DTV mode	13
	REMOTE CONTROL INSTRUCTIONS in TEXT mode	14
	REMOTE CONTROL INSTRUCTIONS in DVD mode	15
	REMOTE CONTROL SETUP	16
<b>7</b>	<b>MENU OPERATION</b>	<b>17</b>
	TUNING MENU	17
	AUTO TUNING	17
	DTV MANUAL TUNING	18
	ATV MANUAL TUNING	18
	PROGRAM EDIT	19
	PICTURE MENU	20
	SOUND MENU	21
	TIME MENU	22
	OPTION MENU	23
	LOCK MENU	24
	EPG MENU	24
	Fast CHANNEL List	25
	INPUT SOURCE	25

<b>8</b>	<b>DVD OPERATION</b>	Basic operation	26
		Digital audio/jpeg playback	26
		Function settings	27
		System setup	27
		Screen saver	28
		Password	28
		Rating	29
		Language setup	30
		Audio setup	31
		Audio compression setup	32
<b>9</b>	<b>TROUBLESHOOTING AND ADVICE</b>		33
<b>10</b>	<b>DISC CARE</b>		34
<b>11</b>	<b>Useful Information</b>		35
<b>12</b>	<b>SPECIFICATIONS</b>		35
<b>13</b>	<b>Wall Mounting</b>		36

## 1 : Safety Information

---

Thank you for purchasing this state of the art TV and DVD. Please carefully read this manual before installing and using the tv. Keep this manual handy for future reference. If the tv is damaged in transit do not attempt to use it, but contact the supplier immediately.



The lightning flash with arrowhead symbol, within an equilateral triangle, is intended to alert the user to the presence of un-insulated “dangerous voltage” within the products enclosure that may be of sufficient magnitude to constitute a risk of electric shock to the persons.



The exclamation point within an equilateral triangle is intend to alert the user to the presence of important operating and maintenance (servicing) instructions in the literature accompanying the appliance.



Correct disposal of this Product(Waste Electrical & Electronic Equipment ( WEEE)  
The crossed out “Whee bin” is intended to show that this appliance must not be placed with ordinary household waste at the end of its useful life. To prevent possible harm to the environment or human health from uncontrolled waste disposal, please keep separate from other household waste and recycle it responsibly to promote the sustainable reuse of material resources.

Household users should contact either the retailer where you purchased the product, or their local government office for details of where and how you can take this item for environmentally safe re-cycling.

Business users should contact their supplier and check the terms and conditions of the purchase contract. This product must not be mixed with other commercial wastes for disposal.



This unit is a “CLASS 1” laser product. This product uses a visible laser beam which could cause hazardous radiation exposure. Ensure the recorder is operated as instructed. Do not remove any covers or look into the DVD drawer opening whilst power is applied. Do NOT modify or adjust any controls that may affect laser emissions. Should the appliance become faulty consult a qualified technician.



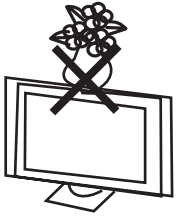
This appliance complies with European Safety and Electrical directives

## 2: Safety Precautions

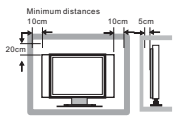
---



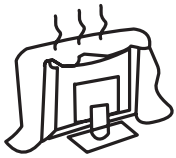
**Unpacking and Handling.** Open the carton carefully and remove the top polyfoam packing. Carefully lift the Tv (2 persons) and place onto a firm stable surface. Lift off the Poly bag and retain all packaging for future use. Keep all packaging away from small children and animals.



**Placing Tv.** The tv should be placed on a firm table or shelf. Do not place in a cabinet unless there is sufficient spacing for air flow and access for the DVD player opening.



**Connections.** When connecting the tv to external sources and the mains supply, do not place wires that can be tripped over. Do not place heavy objects, bend or trap the mains lead.



**Top of Tv.** Do not place objects such as vases, candles or other objects which may spill into the Tv.



**Ventilation and Heat Sources.** Do not place material over the ventilation slots, this will cause the tv to overheat and fail. Do not place the Tv in direct sunlight or near heat sources such as radiators or fires.



**Moisture.** Do not place the Tv in wet or damp conditions, such as steamy kitchens, basements or other damp places. Do not allow water or other fluids to enter the Tv. Do not touch the Mains plug with wet hands. Should moisture enter the Tv , disconnect from the supply and call the customer help line.



**Cleaning.** Disconnect the Tv from the mains supply. Use a soft dry cloth, for stubborn stains use a soft moist cloth with a dilute mild detergent. Do NOT use petrol based fluids



**Leaving your Tv.** Do not leave your tv operating whilst un attended. It is wise to switch off at the Power switch. To conserve power do not leave the tv in standby for long periods “overnight”. When leaving the tv for long periods “holidays” and when local thunderstorms occur, disconnect the aerial “if external” and mains supply.

### 3 : Accessories

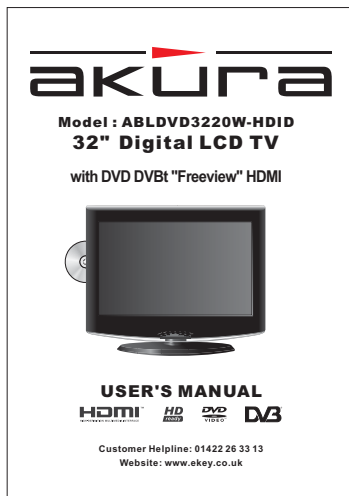
---



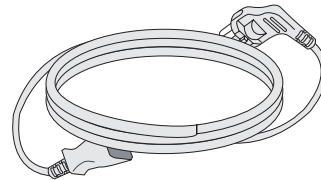
**LCD TV SET**



**Remote Control**



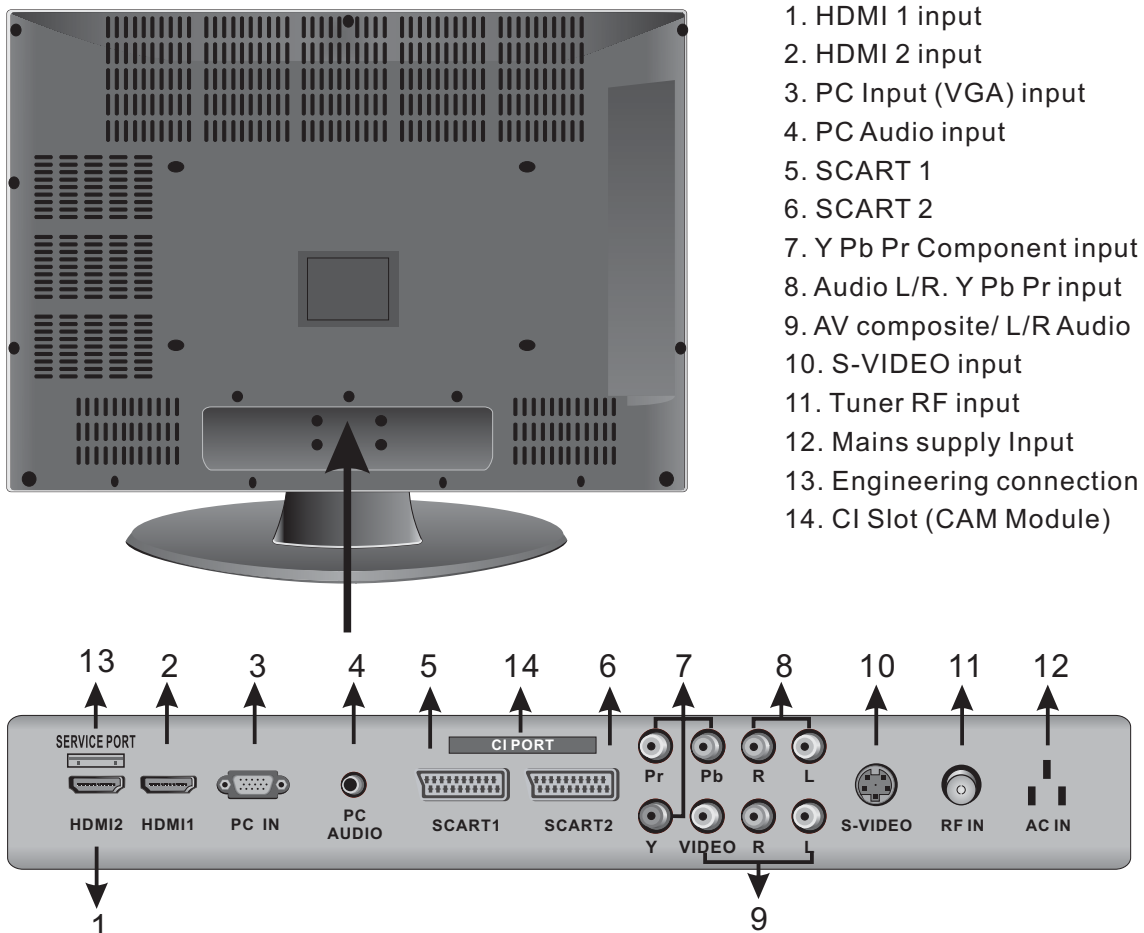
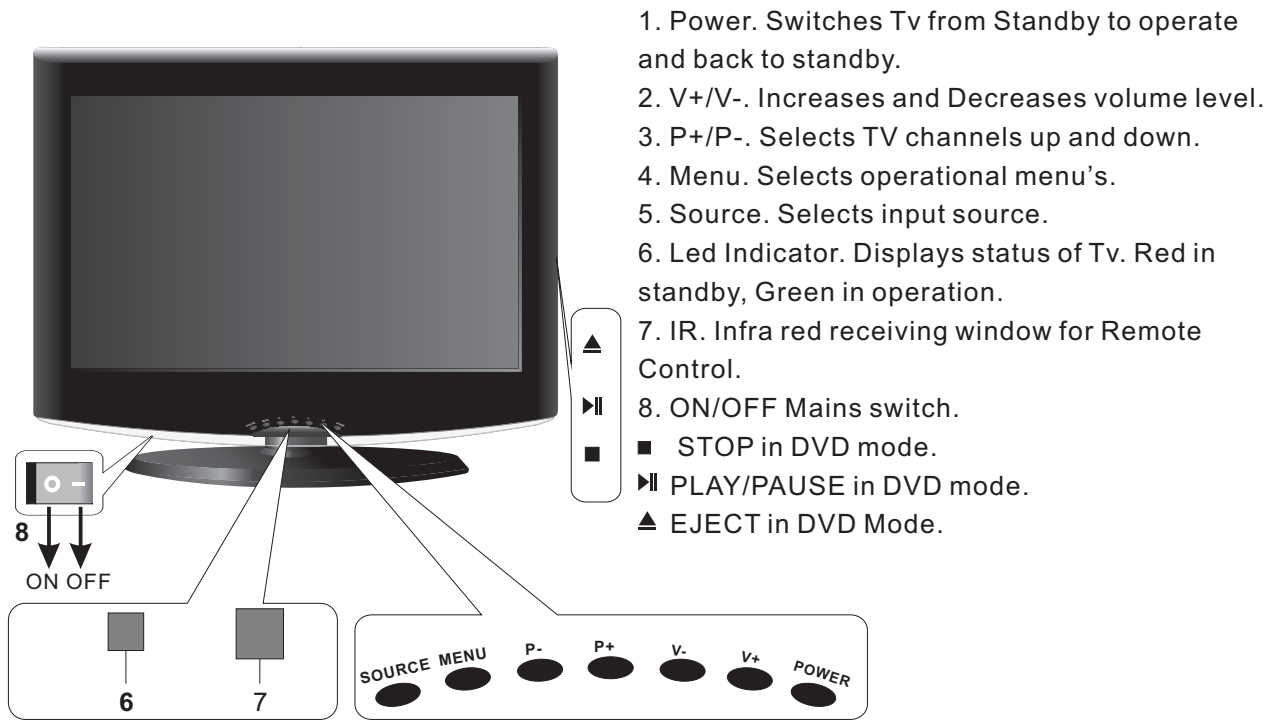
**User's Manual**



**Power Cord**

Should any of the items be missing or damaged. Please contact your point of purchase.

## 4 : Front Controls and Rear Connections



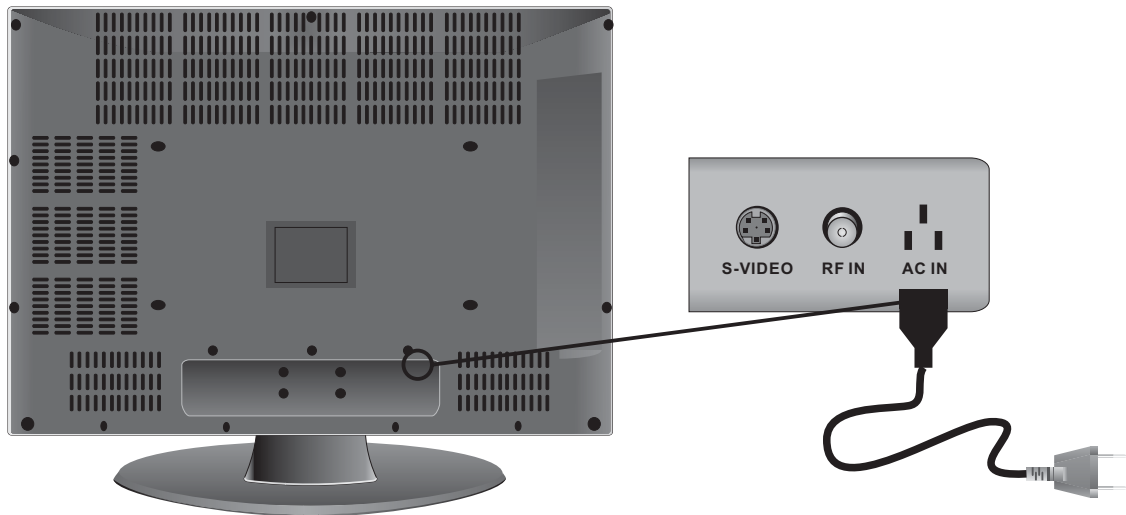
## 5 : Tv Installation Connections

---

### Mains lead Connection

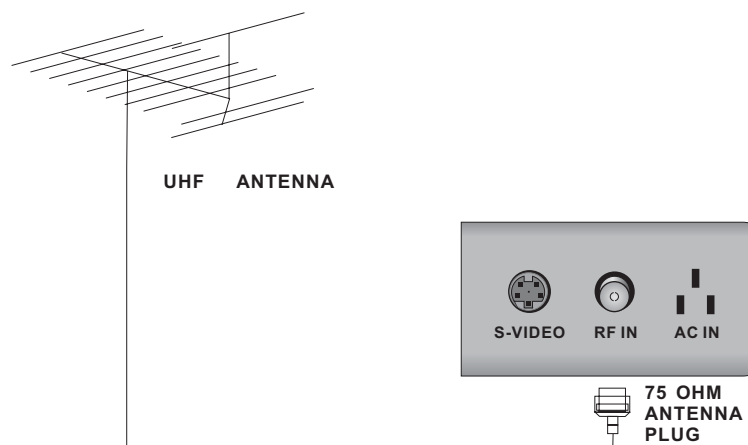
Connect the Mains lead as shown.

Press the POWER switch to turn the Tv on. The LED will change from Red to Green.



### Antennas Connection

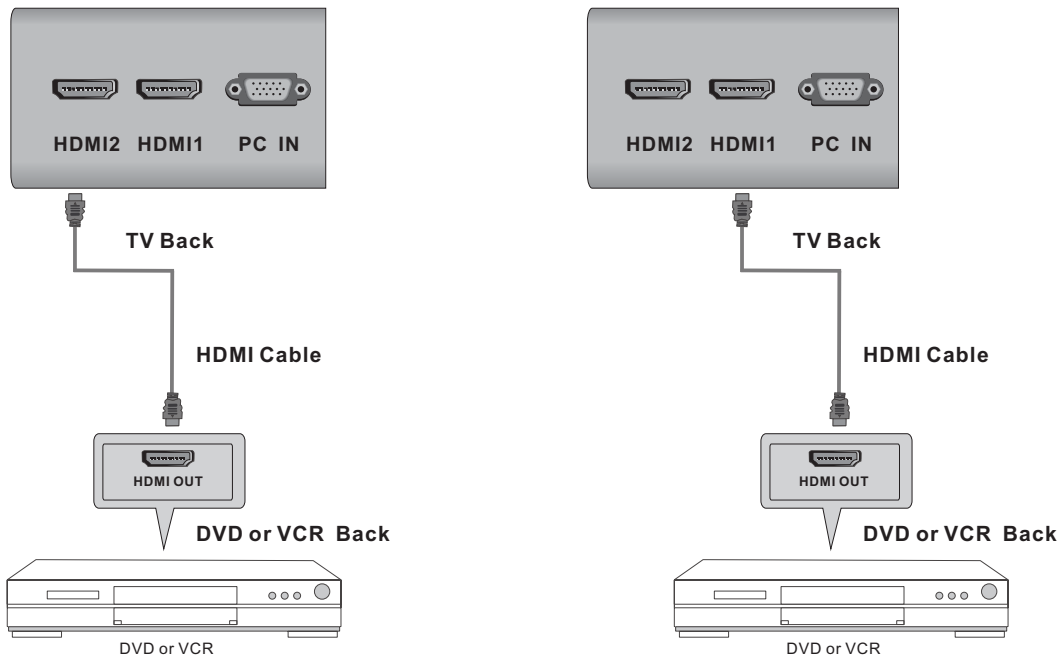
Insert the Tv Antenna plug into the rear of the Tv as shown. For best results an external (outdoor) antenna is recommended. DVBt (digital) signals need to be of high quality. If your antenna system is old it may need replacing.





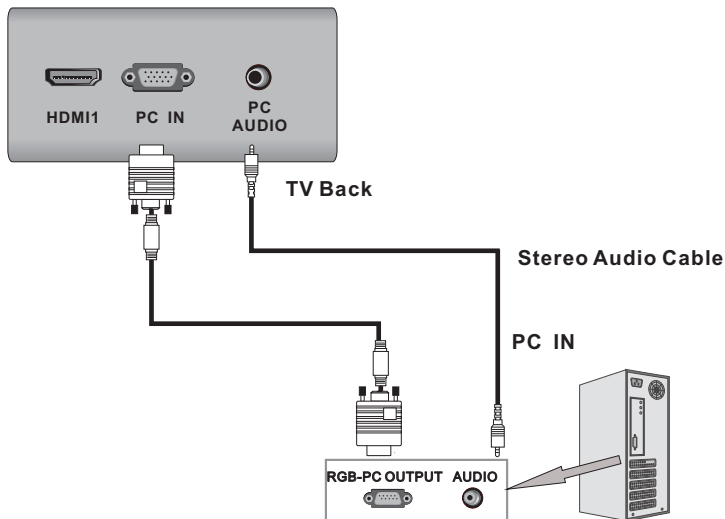
---

## HDMI Connection



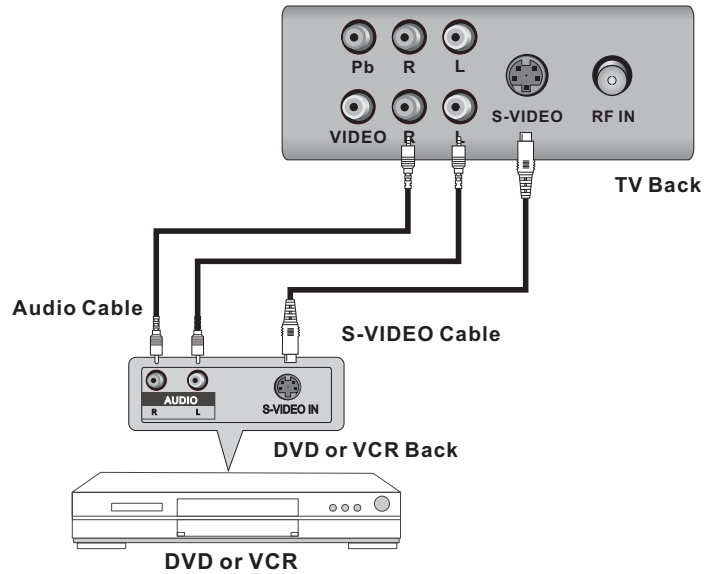
Connect HDMI output from DVD/VCR or X box or similar to the tv and use the "SOURCE" button to select HDMI 1 or 2. (Leads not supplied)

## PC Connection



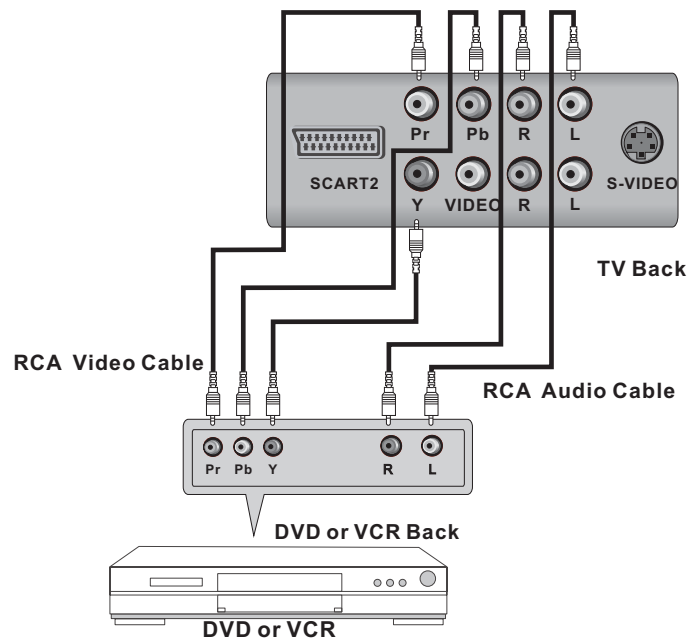
Connect the VGA output from your PC to the VGA input of the tv. If you are using sound, connect the PC audio to the tv PC audio input (leads not supplied). Use the SOURCE button to select VGA

## S-VIDEO Connection



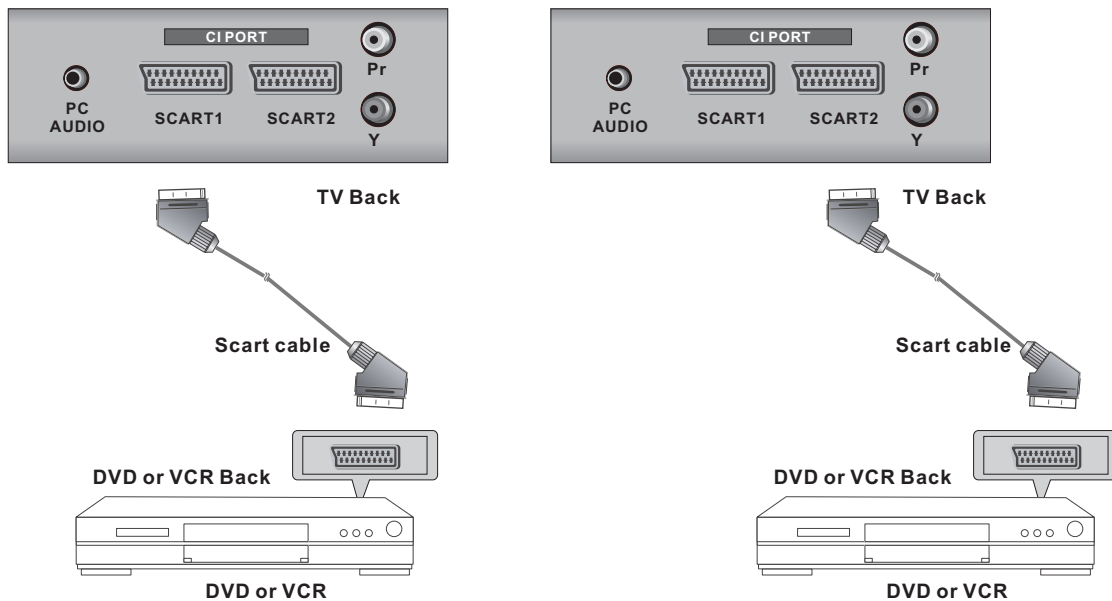
Connect the S\_VIDEO output of the DVD, VCR or other item, to the S-VIDEO input on the tv. The picture quality will be improved compared with SCART or AV input. Connect the Audio output of the DVD, VCR or other item to the Audio input sockets on the tv using a stereo RCA cable (not supplied). Select S-VIDEO using the SOURCE button on the remote control or tv. Do not connect more than one video cable to each item as this may cause interference on the picture.

## YPbPr Connection



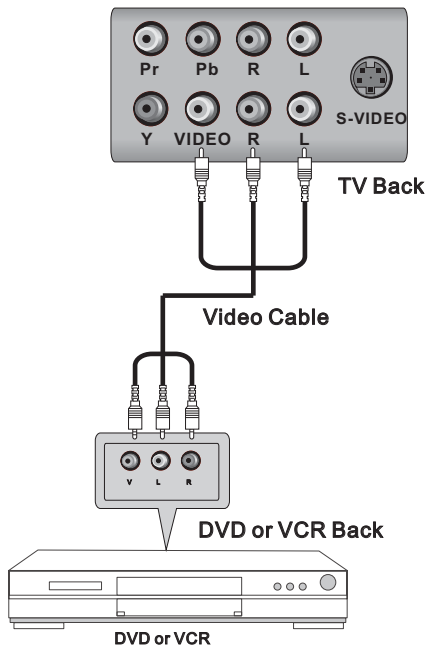
Connect the Y PbPr output of the DVD, VCR or other item to the Y PbPr input on the tv. (lead not supplied). The picture quality will be improved, compared with SCART or AV input. Connect the Audio output of the DVD, VCR or other item to the Audio input sockets of the tv, using a stereo RCA cable, (not supplied). Select HD using the SOURCE button on the remote control or tv. Do not connect more than one video cable to each item as this may cause interference on the picture.

## SCART Connection



Connect the SCART connector to the external video item and the SCART connector on the tv. (lead not supplied). The SCART lead operates as an Input/Output connection. If the tv does not select the SCART input automatically, select SCART using the SOURCE button on the remote control or tv.

## AV Connection



Connect the Video and Audio output connections of the external item to the Video and Audio inputs on the tv. Match the colours correctly, Video is Yellow, Audio Left is White, Audio Right is Red. Select AV as the Source using the SOURCE button on the remote control or tv.

# CAM (Conditional Access Module)

**Using a CAM (Conditional Access Module) (CI Slot).**

This feature allows the user to access digital terrestrial “pay per view” channels. To use the facility a conditional access module (CAM) and viewing card need to be obtained by subscribing to a pay channel company.

To insert the module, Ensure the TV is fully disconnected from the power source.

Insert the CAM into the CI slot ensuring that the label is facing towards the “wall” see Fig 1. A positive stop should be felt if correctly fitted. DO NOT force the module.

To release the CAM hold the two sides with fingers and pull gently. Re connect the TV to the power and switch on. Select DTV.

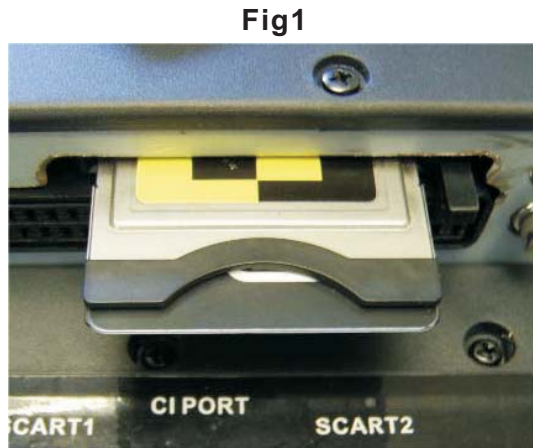
Insert your “Pay per view” card, “do NOT touch the gold contacts”.

Press the MENU button and enter the TUNING menu. Select CI Information and press ENTER. (Fig 2) Select Module Information and press ENTER (Fig 3) To see the card information, select Card Information and press ENTER.

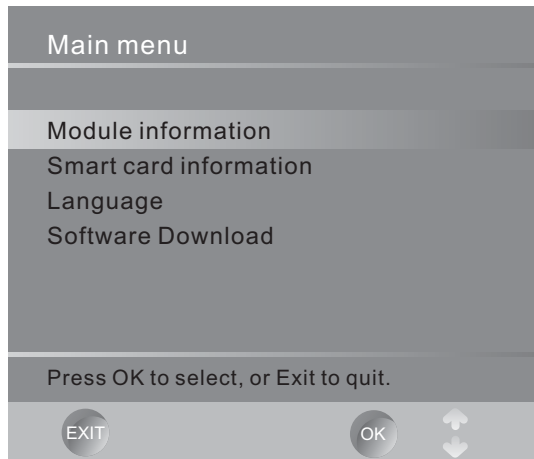
If everything is working satisfactorily you should see the information similar to Fig 4.

Exit the menu’s by pressing MENU or let the TV time out automatically and you are ready to view “pay per view”.

To obtain the CAM and pay per view card, these may be purchased from good high street stores.



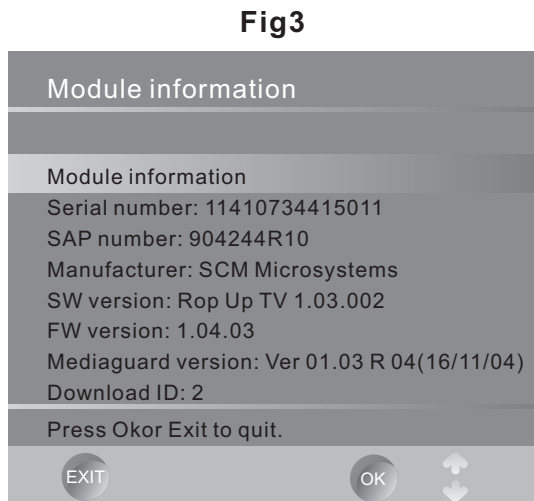
**Fig1**



**Fig2**

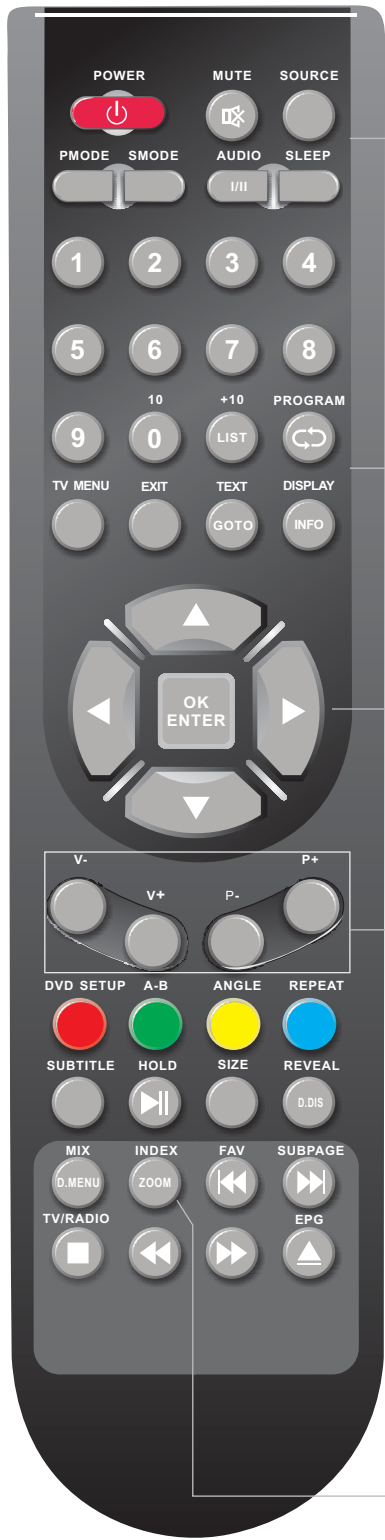


**Fig1**



**Fig3**

Remote control instructions in TV mode



**POWER**  
Turns Tv on and back to Standby.

**MUTE**  
Press to mute the sound. Press again or press V+ to un-mute the TV.

**SOURCE**  
Press to display SOURCE Menu. Press ▼/▲ to select the required source and press ENTER.

**P.MODE**  
Press repeatedly to cycle through the available video picture modes.


**S.MODE**  
Press to cycle through the different sound settings.

**AUDIO(I/II)**  
Selects NICAM or Mono if transmitted.

**SLEEP**  
Press to select time tv will switch off to standby.

**NUMBER BUTTONS**  
Press 0 – 9 and 10,+10 to select tv channels directly..

**LIST**  
Press to display the TV program list.

  
Return to the previous channel viewed.

**DISPLAY(INFO)**  
Press to display the source and channel's information.

**INFO**  
Shows information about the current channel.

**THUMBSTICK( ▲ / ▼ / ◀ / ▶ / OK ENTER )**  
Allows you to navigate the on-screen menus and adjust the system settings to your preference.

**TV MENU**  
Displays the operating menu.

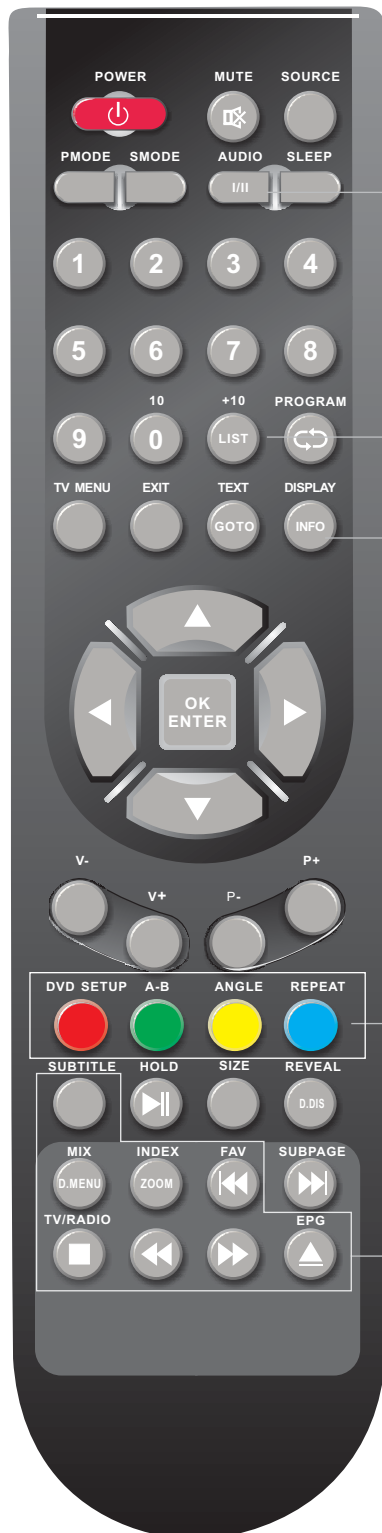
**EXIT**  
Exit the main TV menu to the screen.

**V+/V-**  
Press to increase / decrease the sound level.

**P+/P-**  
Press to scan through channels.

**ZOOM**  
Selects screen display ratio.

## Remote control instructions in DTV mode



### AUDIO

To display audio menu.

### LIST

Press to display the DTV program list.

### INFO

Shows information about the current channel.

### COLOR BUTTONS

Select 4 Preferred TELETEXT pages.

### SUBTITLE

To display subtitle menu.

### FAV

Press to increase/decrease your favourite program

### EPG

Launches the EPG (Electronic Program Guide).

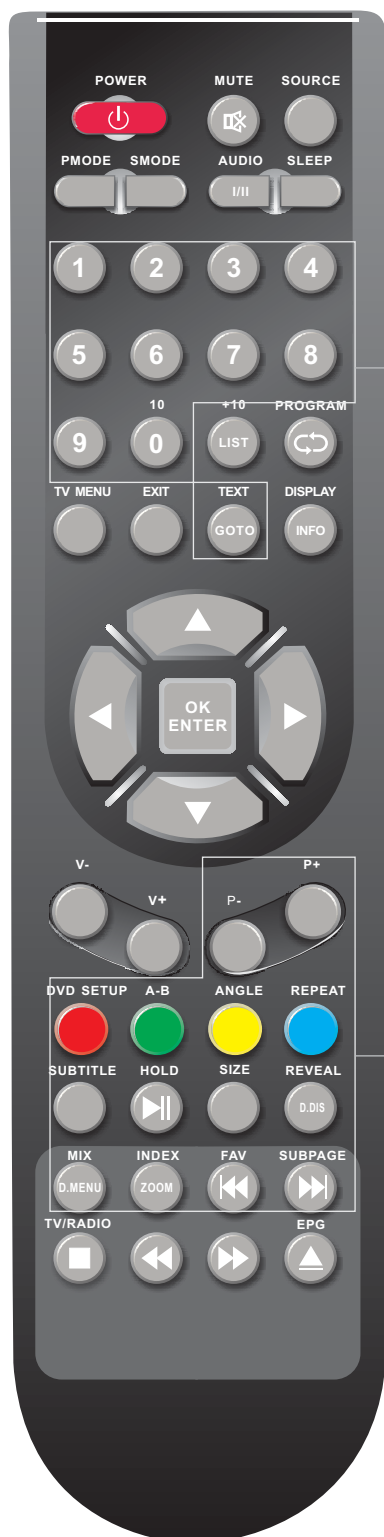
### TV/RADIO

Selects TV or Radio modes.

### ZOOM

Selects screen display ratio.

## Remote control instructions in TELETEXT mode



### NUMBER BUTTONS

Press 0-9 to select a teletext page.

### TEXT

Press to switch between TV and Teletext mode or DTV and Teletext mode.

### P+/P-

Page up and Page down.

### COLOR BUTTONS

Select 4 Preferred TELETEXT pages.

### SUBTITLE

Press to displays subtitles, press again to turn off.

### HOLD

Freeze the current page.

### SIZE

Press to magnify text size.

### REVEAL

Reveal or hide the hidden words.

### MIX

TV and TXT pictures are mixed together in transparent background.

### INDEX

Request index page when index link is valid.

### SUBPAGE

TELETEXT Subpage.

## Remote control instructions in DVD mode



### AUDIO(I/II)

AUDIO selection buttons in DVD mode.

### NUMBER BUTTONS

Numerical buttons for various data.

### PROGRAM

Program a disc playing in a desired sequence.

### GOTO

It is possible to get access to any point on the directly using the 'GOTO' menu.

Press GOTO to access the 'GOTO' menu.

### THUMBSTICK(▲/▼/◀/▶/OK)

Allows you to navigate the on-screen menus and adjust the system settings to your preference.

### DVD SETUP

Enters the DVD player setup menu.

### A-B

This button enables you to repeat a selected section from the disc.

### ANGLE

Selects various camera angles for certain scenes or passages on the DVD during playback.

### REPEAT

Press REPEAT to cycle through the repeat play options.

### SUBTITLE

Select a different subtitle language (the DVD disc must have the subtitle you selected).



PLAY/PAUSE.

### D.DIS

Press to display the DVD information.

### D.MENU

DVD disc menu Access to menu.

### ZOOM

Selects picture magnification.



Jump to previous and next track.



DVD STOP



Fast backward and forward key.



EJECT

To eject the disc.



---

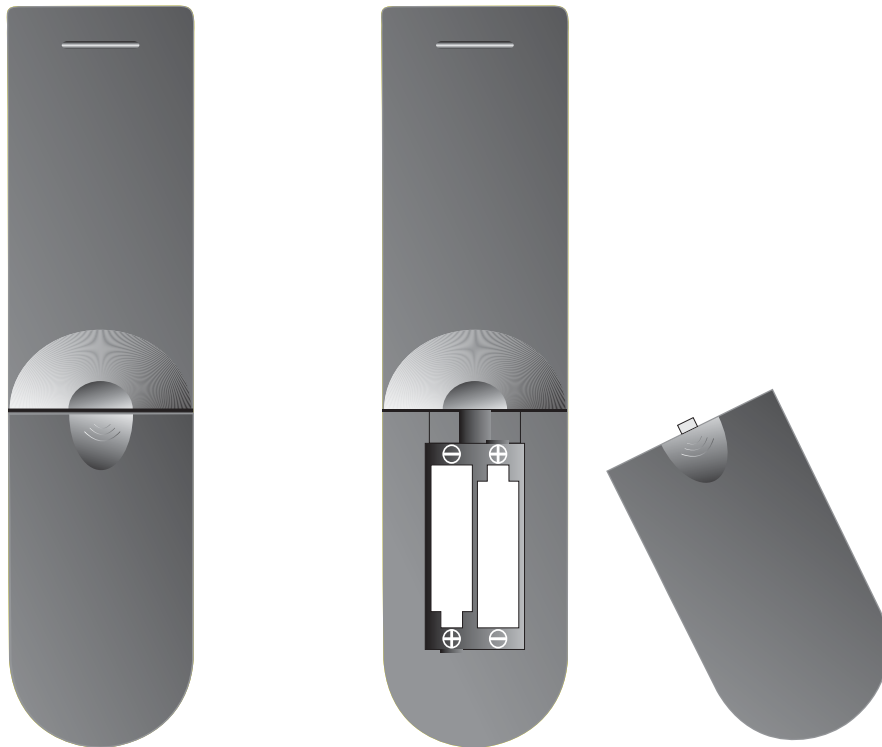
## Remote control setup

1. Open the battery cover
2. Fit two “AAA” batteries (Not supplied). Ensure the battery polarities are correct i.e + to + and – to -.
3. Replace the battery cover

To prevent injury, do NOT break open or throw exhausted batteries in a fire. Do not place in the domestic waste, consult your local waste disposal company.

Do not mix batteries, old and new, Carbon or Alkaline.

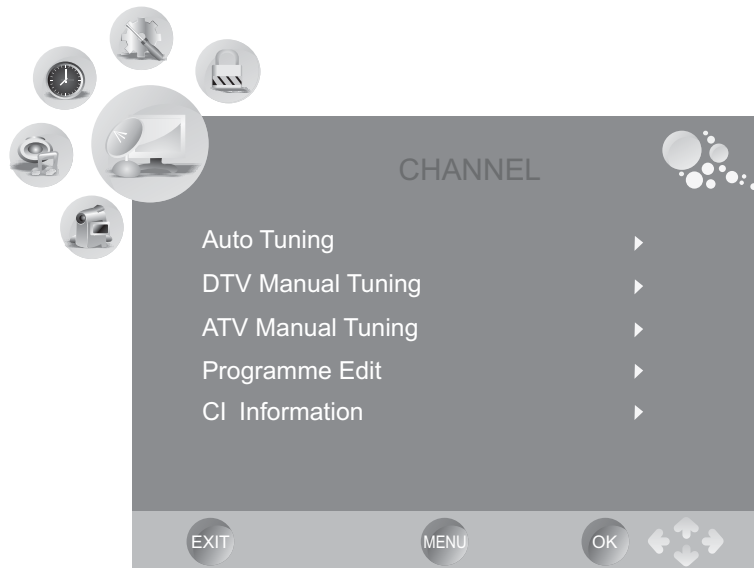
Do not use re chargeable batteries. Remove batteries if not using the remote control for long periods to prevent leakage. If the batteries do leak, clean the compartment with soapy water and scrape any residue from the contacts. To NOT touch or ingest battery residue.



## 7 : MENU OPERATION

---

### CHANNEL Menu

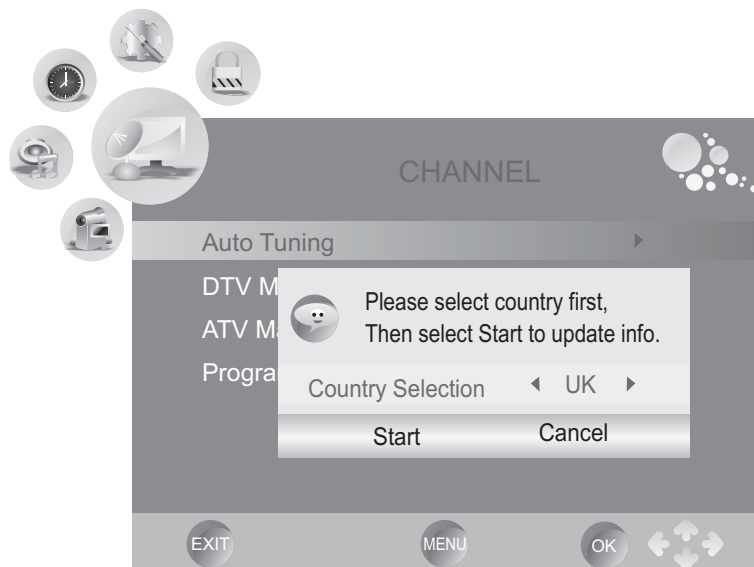


Press ▲/▼ to select the item required and ► or OK to confirm.

Press MENU to return to a previous menu.

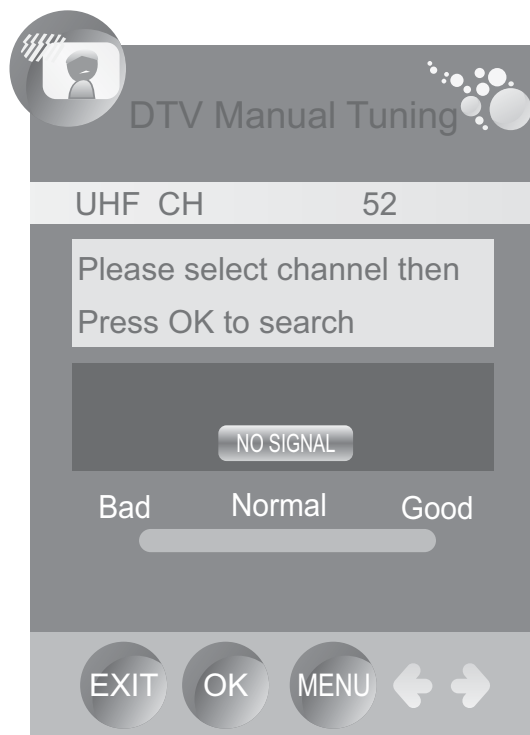
Press EXIT to exit the menu's.

### Auto tuning



Press ◀/▶ to select the country, then OK to confirm. When it is Auto Tuning, press MENU to skip the current tuning (ATV or DTV), or EXIT to return to the previous menu.

## DTV Manual Tuning



Press ◀▶ to select the channel, then OK to search.

## ATV Manual Tuning



Press ▲/▼ to select. Press ◀/▶ to adjust as required. See details in the following sub-option. Select SAVE and press ENTER/OK

---

**To Store.**

Press ◀/▶ to select the channel number you want to save to.

**System.**

Press ◀/▶ to select the sound system. In the UK it is "1", Western Europe "B/G", Eastern Europe "D/K". Parts of France "L" or "LL".

**Current Channel.**

Press ◀/▶ to select the current channel number.

**Search.**

Press ◀/▶ to search up or down. Press MENU or EXIT to stop search.

**Fine Tune.**

Press ◀/▶ to adjust the Fine tuning, normally this will not require adjustment, unless you have sound or picture interference.

**Skip.**

Press ◀/▶ to turn Skip On or Off. When Skip is On, the P+/P- buttons will not select that channel, however the numeric buttons will still select "skipped" channels.

**Frequency.**

Displays the frequency of the currently selected channel.

## Program Edit

**Delete**

Press ▲▼ to select the channel you want to delete, then press DELETE (RED), and the channel will be marked DELETE, press DELETE (RED) again to delete, or MENU to cancel.

---

**Rename.**

Press ▲/▼ to select the channel you want to rename. Press (Green) "Rename" to mark the selected channel. Press ◀/▶ to select the position in the word, then press ▲/▼ to select the letter or number required. To exit, press EXIT or wait for the menu to "time out".

**Move.**

Press ▲/▼ to select the channel you want to move, press (Yellow) "Move", this marks the channel you wish to move. Press ▲/▼ to select the location you want to move to. Press Menu or Exit to cancel.

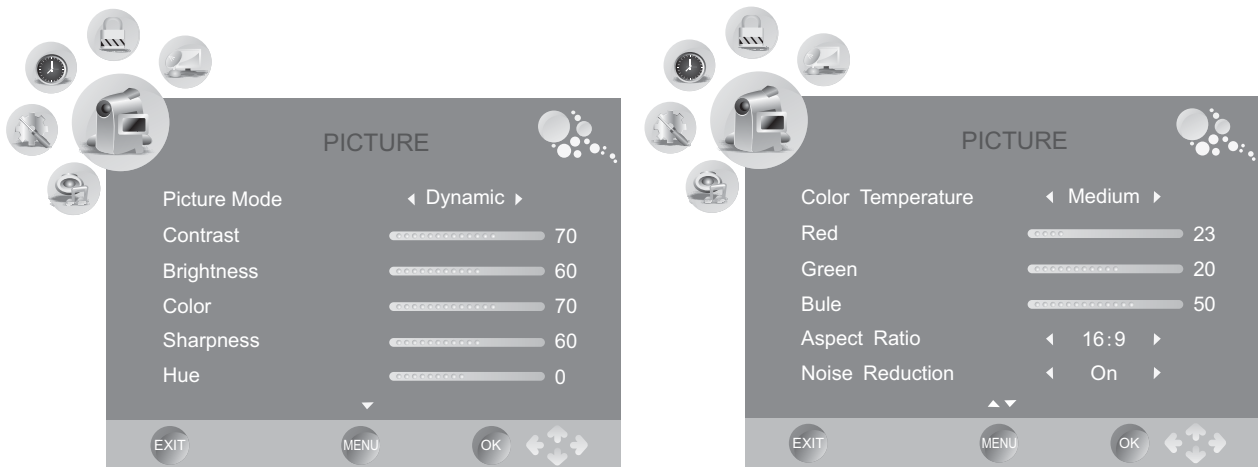
**Skip.**

Press ▲/▼ to select the channel you want to Skip, press (Blue) "Skip" to mark that channel. To "unskip" that channel press (Blue) again. When Skip is selected P+/P- will not select that channel, however the numeric buttons will still select that channel.

**Favourite.**

Press ▲/▼ to select the channel you want to add to the Favourites List, then press FAV to mark or "un mark" that channel. Any channel marked FAV will be added to the Favourites list.

## PICTURE menu



Press MENU to display the menu, press ◀▶ to select the PICTURE menu, Press ▼ Change letter size to normal the submenu.

Press MENU to return to the main menu from the submenu.

**Picture Mode**

Press ◀▶ to select picture mode. Dynamic, Standard, Mild, User. Press OK to confirm and return to the previous menu.

**Contrast**

Press ◀▶ to adjust the contrast.

**Brightness**

Press ◀▶ to adjust the brightness.

**Color**

Press ◀▶ to adjust the color saturation.

### Sharpness

Press ◀▶ to adjust the sharpness.

### Color Temperature

Press ◀▶ to select Color Temperature. Cool, User, Warm, Medium

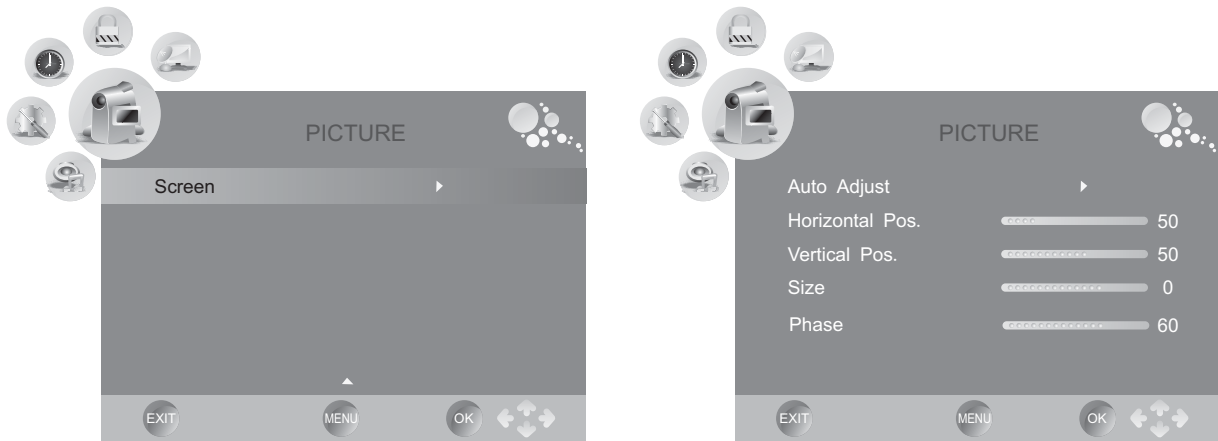
### Aspect Ratio

Press ◀▶ to select Aspect Ratio. Zoom1, Zoom2, Auto, 4:3, 16:9.

### Noise Reduction

Press ◀▶ to turn On or Off the Noise Reduction.

**Screen ( Only available in PC mode).**



**Auto Adjust** Select “Auto Adjust” and press ▶, the unit will automatically adjust and press RIGHT, the unit will automatically adjust all items to achieve a best effect.

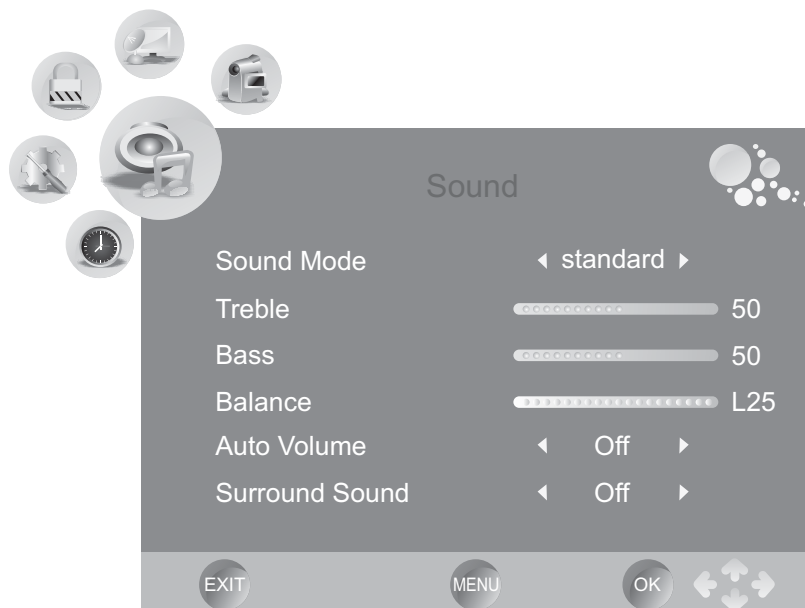
**H-Position** Allows you to use ◀▶ buttons to adjust the H Position.

**V-Position** Allows you to use ◀▶ buttons to adjust the V Position.

**Size** Allows you to adjust the width of image.

**Phase** Allows you to adjust the definition.

## SOUND menu



---

Press MENU to display the menu, press ◀▶ to select the SOUND menu , Press ▼ to enter the submenu.

Press MENU to return to the main menu from the submenu.

**Sound Mode**

Press ◀▶ to select sound mode. Music, Movie, Sport, User, Standard.

Press OK to confirm and return to the previous menu.

**Treble**

Press ◀▶ to adjust the treble level.

**Bass**

Press ◀▶ to adjust the bass level.

**Balance**

Press ◀▶ to adjust the sound balance.

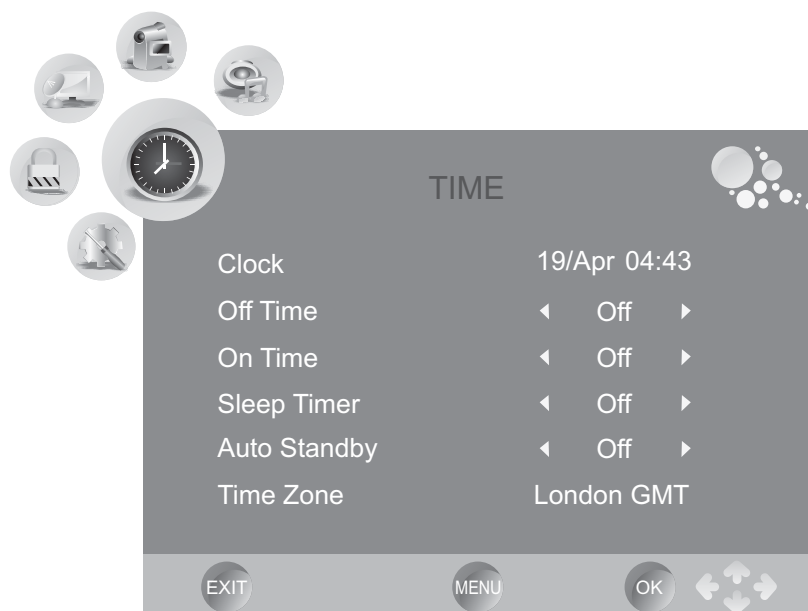
**Auto Volume**

Press ◀▶ to select On or Off.

**Surround Sound.**

Press ◀▶ to select On or Off.

## TIME menu



Press ENTER to display the menu, press ◀▶ to select the TIMER menu , press ▼ to enter the submenu.

Press MENU to return to the main menu from the submenu.

### **Clock**

Press ► to select Date, Month, Year, Hour and Minute, press ▲▼◀▶ to set the time.

### **Off time**

This is a “Stand alone” function. It will not work in conjunction with the “On Time” setting. Press ► to select on, press ▲▼ to enter the setup item, use ▲▼◀▶ to set the time you want the TV to be turned off.

### **On time**

This is a “Stand alone” function. It will not work in conjunction with the “Off Time” setting. Press ► to select on, press ▲▼ to enter the setup item, use ▲▼◀▶ to set the time you want the TV to be turned on.

### **Sleep Timer**

Allows you to set up the sleep timer from: 10min, 20min, 30min, 60min, 90min, 120min, 180 min, 240min and off.

### **Auto Sleep**

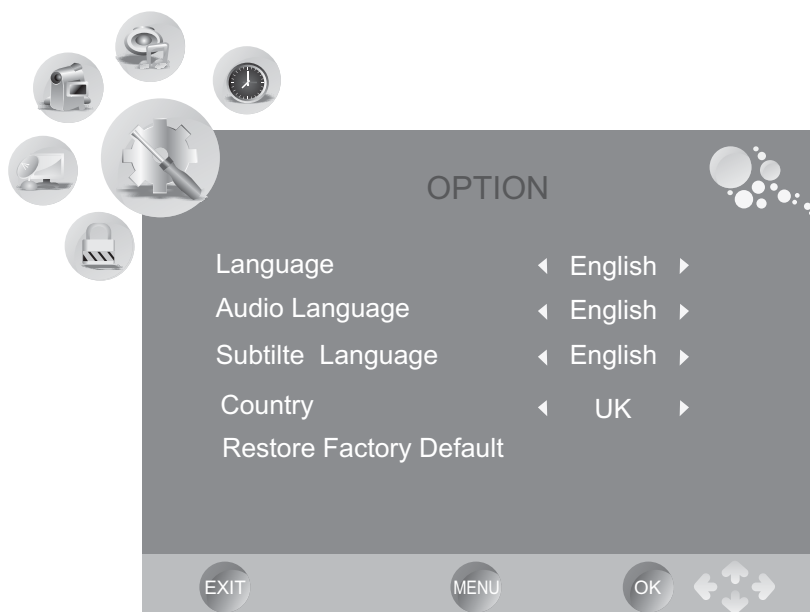
Automatic shutdown function of timing options.

### **Time Zone**

Allows you to set up the time zone, default London GMT.

This tv does not recognise British Summer Time (BST). To operate the timer in BST mode select “Belgium” (+ 1 hr).

## OPTION menu



Press MENU to display the menu, press ► to select the OPTION menu , press ▼ to enter the submenu.

Press MENU to return to the main menu from the submenu.

### **Language**

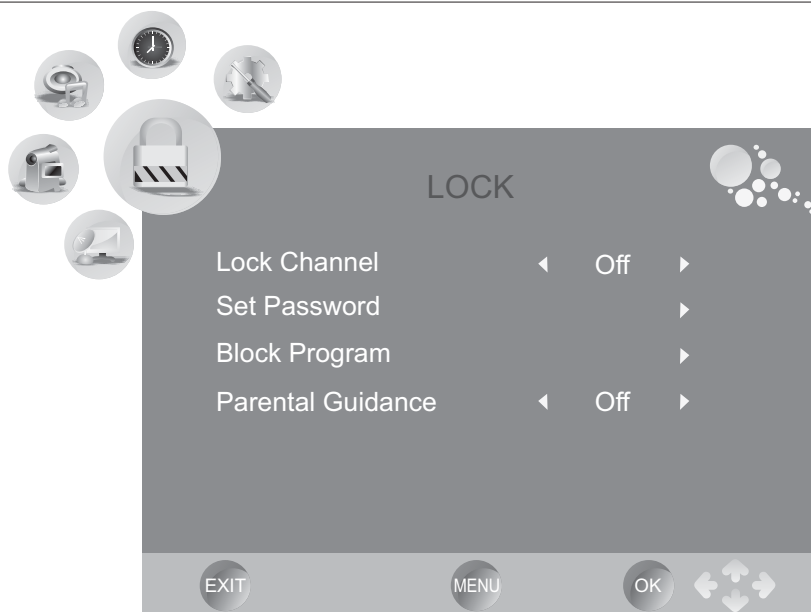
Press ◀▶ to select the OSD, Audio and Subtitle languages.

### **Restore Factory Default**

Press ► to restore factory defaults.



## LOCK menu



Press MENU to display the menu, press ◀▶ to select the LOCK menu, press ▼ the default password is "0000", and ▲▼ to enter the submenu.

Press MENU to return to the main menu from the submenu.

### Lock Channel

Press ◀▶ to select on or off.

### Set Password

Press ▶ and enter a new 4 digit password. If you forget the new password "8899" will work.

### Block Program

Select CHANNEL LOCK and press ▶ This will display the Channel list. Select the channel to lock using the ▲/▼ buttons, and press GREEN. A Lock will be displayed along side the locked channel. To unlock, press GREEN again.

### Parental Guidance

In DTV mode, press ◀▶ to select Parental Guidance's grade.

## EPG Menu

Use EPG button on the remote control to display the EPG menu directly as below: (this only works in DTV mode)

PROGRAMME GUIDE		DTV 803 Data
19 Apr 2008 04:58		00:00-00:00
DTV	04:30	19 Apr 05:30
001 BBC 1		No Information
002 BBC 2		No Information
003 ITV		No Information
004 CH 4		No Information

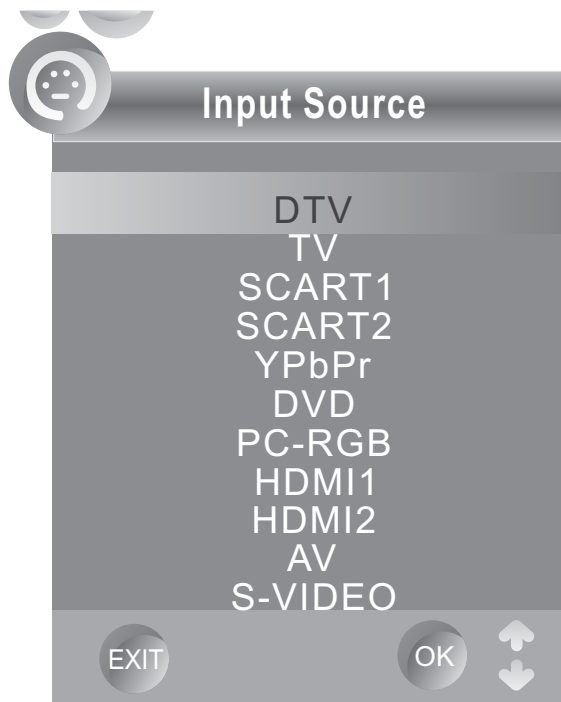
## Fast Channel List



Press List button to enter into Channel List menu directly.

## INPUT SOURCE

Press SOURCE to display the input source, press ▲ ▼ to select the main source, and then press OK to confirm.



## 8 : DVD Operation

### Basic operation

#### 1. Select DVD.

Turn on the TV and press the SOURCE button and then the ▲/▼ to select DVD. Press OK to confirm.

#### 2. Playing discs.

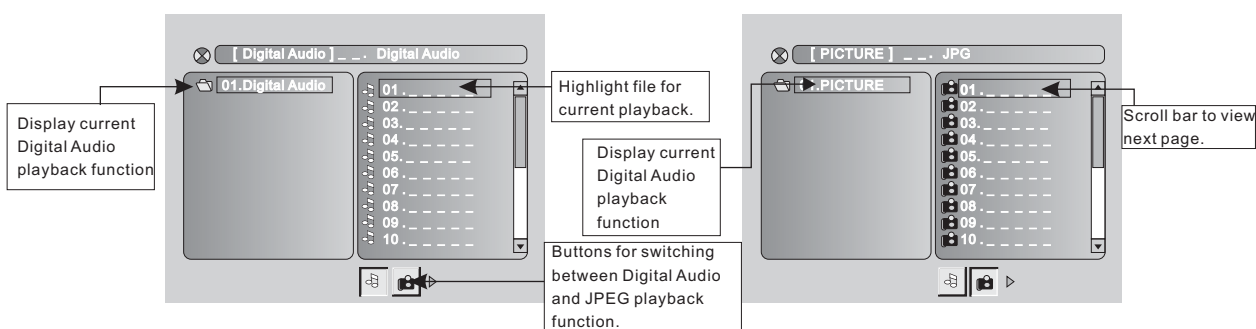
Insert the disc with the label facing AWAY from you. The disc will either automatically start to play, or will display a menu. Use the navigation buttons to select the item you require and press OK.

#### 3. Program playback

Using Program playback, you can select max. 16 chapters from the disc to playback in programmed order. OSD for program playback as below.

### Digital Audio/JPEG Playback

After loading and scanning the Digital Audio / JPEG CD&DVD, it will initially display the - Digital Audio contents automatically and start to play the first file (highlighted file). Screen as follow:



- Using the navigation buttons enables you to select the folder, press OK and then select the file you want to play.

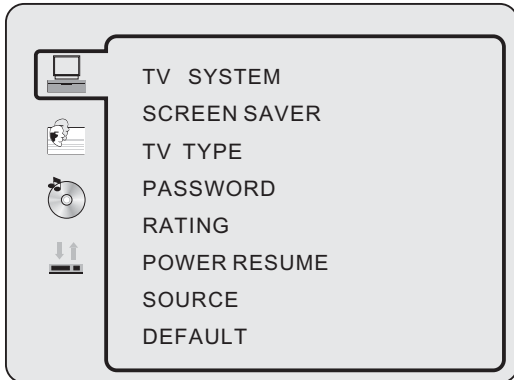
#### NOTE:

- Press ◀▶ buttons to move the highlighted files to folders, documents or mode selection.
- Press numeric buttons to select the contents directly. For number over 10, press +10 button first. (e.g. File number 15, press +10 then 5.)
- When playing Digital Audio files, there is no picture display, only audio output.
- Playing JPEG discs: Press the **PROGRAM** button to select slide effects. There are 17 slide modes, press the **PROGRAM** button to toggle between different modes in sequence. (Start from top Start from bottom Start from left Start from right Start from upper left corner Start from upper right corner Merge from left / right Horizontal blades Vertical blades Merge form 4 corners Random Playback Slide effect OFF).
- When playing or pauseing images, you may use navigation buttons to flip / rotate the picture.
  - ▲ button to flip horizontally.
  - ▼ button to flip vertically.
  - ◀ button to rotate left 90°.
  - ▶ button to rotate right 90°.
- When playing or pausing images, you may use the D.MENU button to enter preview mode to display 12 pictures. Press◀◀ / ▶▶ button to select next / previous page or press numeric buttons to view the corresponding pictures.
- The maximum JPEG image size that can be displayed is 1280 x 1024.

---

## Function Settings

### DVD Function General setup

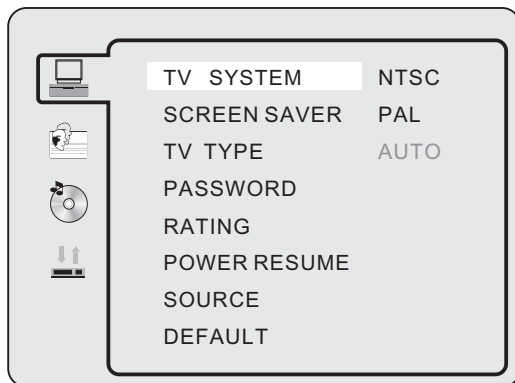


- Press the **DVD SETUP** button to activate the **DVD** player OSD menu;
- Press **▲ / ▼** buttons to move and highlight between different sub-menus. Press **◀ / ▶** ENTER button to enter the highlighted sub-menu.
- Press the **DVD SETUP** button to exit the OSD menu, or move the highlight to **EXIT DVD SETUP** then press **ENTER** button to exit.

### System Setup

#### TV SYSTEM

- Press **▶** button to enter the **TV SYSTEM**, and then press **▲ / ▼** to select one from below:



#### NTSC

This format is used by some other countries, e.g. USA

#### PAL

This is the format used in the UK.

#### AUTO (Default setting)

This format can be used if your **DVD** is capable of both PAL and NTSC formats.

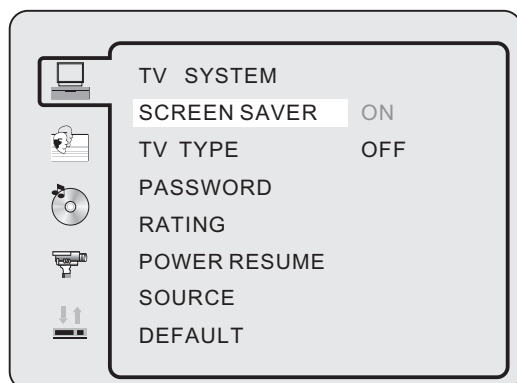
---

## SCREEN SAVER

If the screen saver option is on, when your DVD player is in Stop, Open, or No Disc state, or there is a frame frozen for more than 60sec, the screen saver will be displayed. This feature can protect the screen from damage.

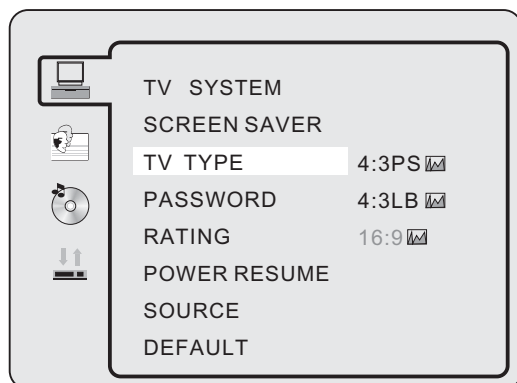
**ON:** Choose this setting to activate the screen saver.

**OFF:** Choose this setting to cancel the screen saver



## TV TYPE

DVD's are produced in a variety of screen aspect ratios. This menu enables you to select one of the three aspect ratios:



- 4:3 PS (Normal)
- 4:3 LB (Normal)
- 16:9 (Wide)

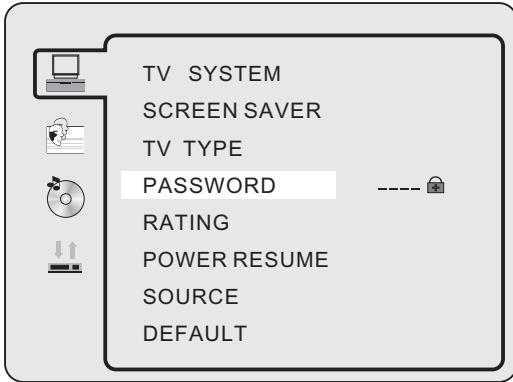
- Select the most appropriate aspect ratio for the JPG being viewed.

## NOTE:

- Playback screen size may vary according to the disc contents.
- For media with 4:3 contents, using any mode would only display a 4:3 screen
- Screen ratio selection should be according to the connected TV / Display aspect ratio.

## PASSWORD

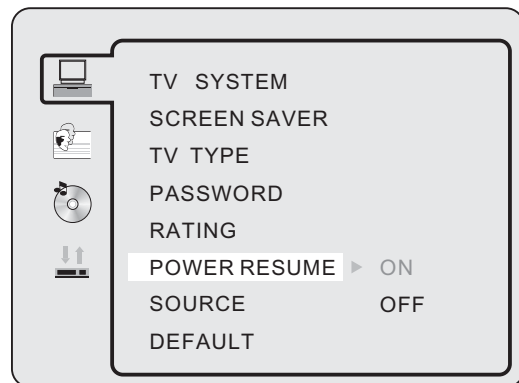
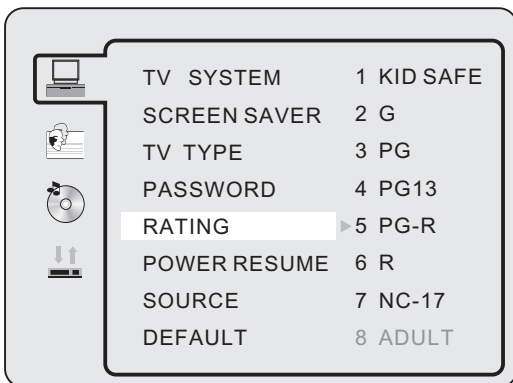
- The default setting is locked. No Rating selection or change password could be done. To edit the Rating setting, please enter default password "0000" using the numeric buttons, then press **ENTER** button to confirm.
- To change password, input any 4 digit number when the lock is unlocked. Once the 4 digit number is entered, that will be your new password.



## RATING

You can select the rating setting according to your preference. Rating restriction is divided into eight different category from KID SAFE to ADULT.

NOTE: Only editable when password is unlocked.



## POWER RESUME

Select "ON" and the disc will resume playing from where it was stopped.

Select "OFF" the disc will start playing from the start.

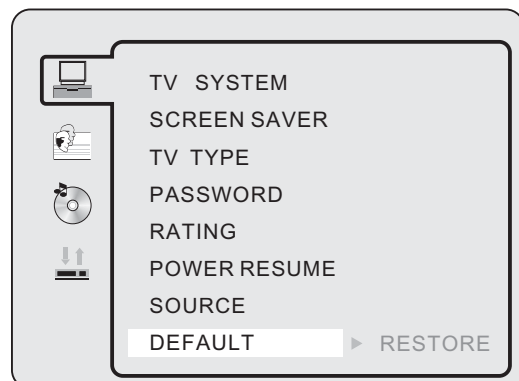
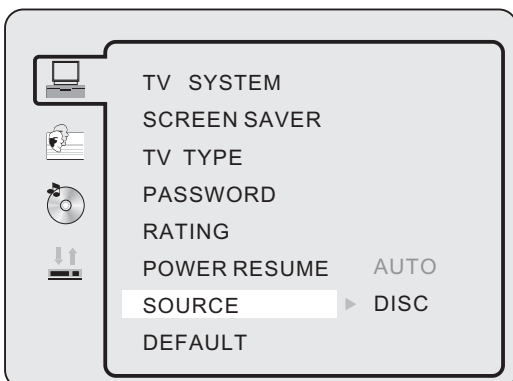
## SOURCE

Use the Up and Down arrow button to select the AUTO/DISC.

## DEFAULT SETTING

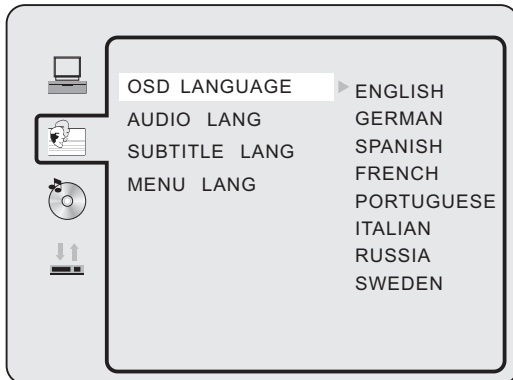
- Press **ENTER** button to restore factory default.

NOTE : This can only be set if the password is locked. It will not reset the Password or Rating settings.



## Language Setup

Press **DVD SETUP** button to enter the **DVD OSD** menu.

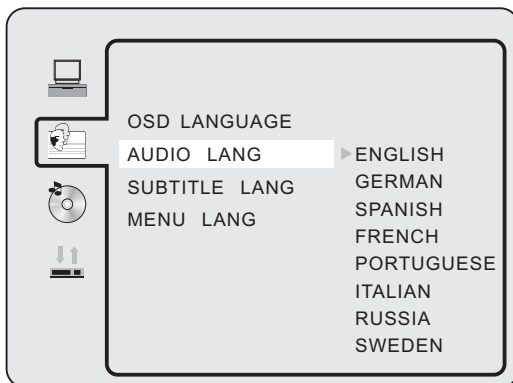


### - OSD Language

Use navigation buttons to select the **OSD LANGUAGE** setup icon, press **ENTER** button to confirm. There are 8 languages for your selection, press **▲** & **▼** buttons to toggle between different languages, Press **ENTER** button to confirm.

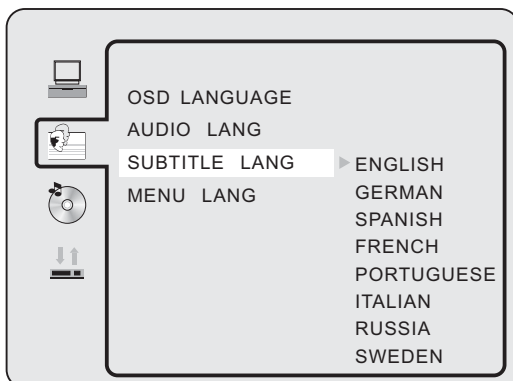
## AUDIO LANGUAGE

Use navigation buttons to select the **AUDIO LANG** setup icon, press **ENTER** button to confirm. There are 8 languages for your selection. Press **▲** & **▼** buttons to toggle between different languages. Press **ENTER** button to confirm.



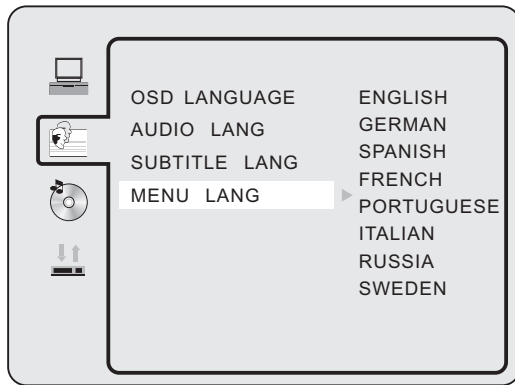
## SUBTITLE LANGUAGE

Use navigation buttons to select the **SUBTITLE LANG** setup icon, press **ENTER** button to confirm. There are 8 languages for your selection. Press **▲** & **▼** buttons to toggle between different languages. Press **ENTER** button to confirm.



---

## MENU LANGUAGE

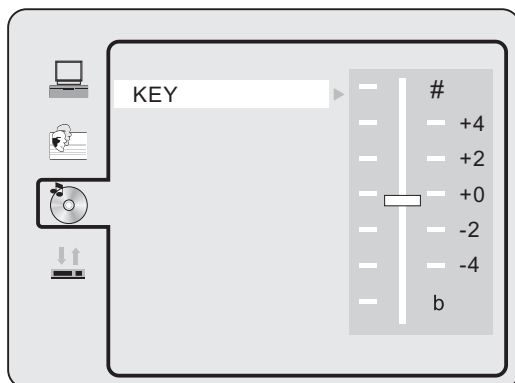


- Use navigation buttons to select the MENU LANG setup icon, press ENTER button to confirm. There are 8 languages for you selection, press ▲ & ▼ buttons to toggle between different Languages. Press **ENTER** button to confirm.

## Audio Setup

### AUDIO setup

The audio setup options are illustrated below:



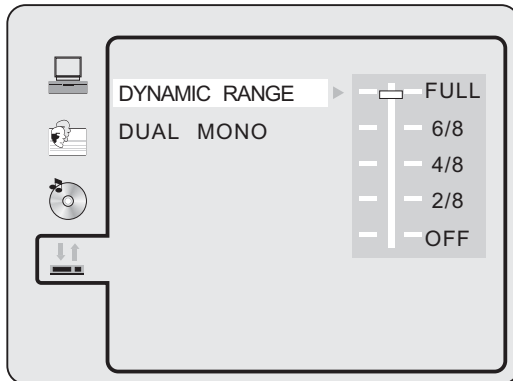
### KEY

- Use the Up and Down arrow button to move the scroll and adjust the KEY.



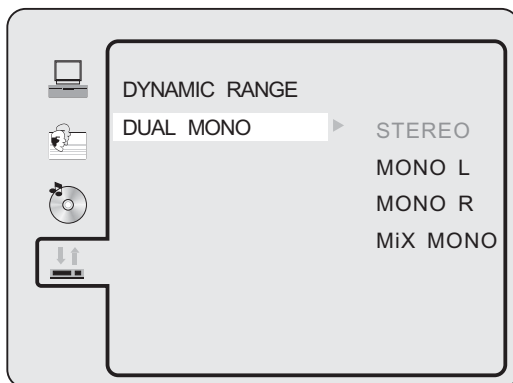
## Audio compression setup

### DYNAMIC RANGE



- Switch the compress mode to “Audio output” to adjust the compress ratio for different effects. When selected FULL, the peak signal value is smallest. When selected OFF, the peak signal value is largest.

### DUAL MONO



- You can select four different audio output, STEREO, MONO L, MONO R, MIX MONO. The audio out description of these Selections is shown in the table below.

MODE	LEFT SPEAKER	RIGHT SPEAKER
STEREO	STEREO-L	STEREO-R
L-MONO	L-MONO	L-MONO
R-MONO	R-MONO	R-MONO
MIX-MONO	L-MONO+R-MONO	L-MONO+R-MONO

## 9 : TROUBLESHOOTING AND ADVICE

Should the TV stop working or work abnormally. Please consult the guide below, before calling the customer help line.

Symptom	Possible cause	Remedy
Dead. No led lit	Power not connected to TV	Check DC connection to TV Check connection to mains supply an that the supply is turned on.
No picture. Led green	TV in wrong input mode. Backlight faulty.	Set TV to TV or DVT modes. Call customer help line
No picture. Blue screen.	No signal input TV not tuned in TV in wrong mode	Is aerial connected See pages 17 Is AV or PC selected
Poor picture in (analog) TV or picture freezing or breaking up in (digital) TV mode	Poor signal to TV	Check aerial connections. If using an indoor aerial it may be necessary to upgrade or exchange aerial to an outdoor aerial
Teletext freezing or breaking up.	Poor signal to TV	As above
Bright or dark spots on screen.	Damage to LCD screen	Not covered in warranty
No Sound.	Mute button pressed Poor external connection	Check mute button has not been pressed If using an external amplifier check connection and it is turned on
Lost or forgotten Pin number (TV)		Enter 8899
	<b>PC OPERATION</b>	
Display shows "No Signal"	Poor connection	Ensure VGA lead is connected properly
	<b>DVD OPERATION</b>	
Disc not playing	Disc not placed correctly. Dirty or damaged disc. Incorrect Region disc	Disc must be placed in the player with label facing away from you. Clean or replace disc. Call help centre.
Picture freezing or breaking up	Dirty or damage disc	Clean or replace disc
Disc will not eject	DVD not selected	Select DVD mode Call Help centre. Do NOT attempt to remove the disc yourself.
Lost DVD PIN code		Enter 8899
	<b>Remote Control</b>	
No or intermittent remote control	Batteries exhausted	Replace batteries each 6 months

If you are still having difficulty please call the Technical help line. Ring 01422 263313 (Normal rates apply). Opening hours Mon-Fri 8am – 4pm. Sat 9am – 4pm. Sun 11am – 4pm " Bank holidays as Sun". Or try our website :- [www.ekey.co.uk](http://www.ekey.co.uk) (24Hr) Emails should be responded to within 3 – 4 hours, should the consumer have difficulty getting through.

## 10 : DISC CARE

---

### About Disc Terms

#### Title

Generally, pictures or music compressed on a DVD are divided into several sections, "title".

#### Chapter

The smaller section unit of picture or music in a DVD under the title, usually one title is comprised of one or more chapters and each of them is numbered for easy searching, but some discs may not have a recording chapter.

#### Track

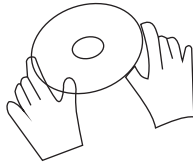
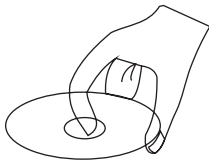
A segment of picture or music on a CD, Each track is numbered for searching.

#### Care of Disc

Video disc contains high-density compressed data that needs proper handling.

1. Hold the disc with fingers by outer edge and/or the center spindle hole. Do not touch the discs surface.

2. Do not bend or press the disc.



3. Do not expose the disc to direct sunlight or heating sources, Store discs in cabinet vertically, and in dry condition.

Prevent exposure to:

Direct sunlight

Heat or exhaust from a heating device

Extreme humidity

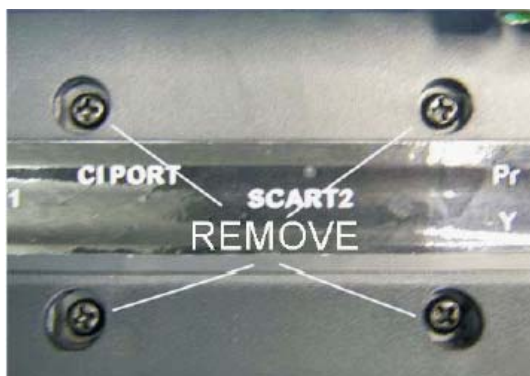
Clean the disc surface with a soft, dry cleaning cloth, Wipe the disc surface gently and radially from center toward the outer edge.

Do not apply thinner, alcohol, chemical solvent, or sprays when cleaning. Such cleaning fluids will permanently damage the disc surface.

## 11 : Wall Mounting.

---

The TV is provided with four mounting holes (6mm isometric threads) for a wall mounting bracket. (not supplied). To remove the TV base, unscrew the 4 screws in Fig 1 and slide the base away from the Tv. Mount the bracket using the manufacturers instructions. Do NOT use mounting screws longer than 16mm. Fit the wall bracket securely following the manufacturers instructions. Akura or it agents accept no responsibility for damage caused by faulty bracket installation.



## 12 : Useful Information.

**Power Consumption Reduction.** To enable the user to reduce the “carbon footprint” of the Tv, it is suggested that the Tv is turned off completely at the mains supply, rather than be left in standby when not in use. This not only reduces the carbon footprint, it increases the safety of the product and it also reduces the annual electricity bill by a significant amount.

**HDMI SETUP** If you are using HDMI for the first time, from a DVD player or similar item, you may need to set the “source” output. To do this connect a “scart” lead and the HDMI lead from the item to the TV, Select SCART1 (if Scart 1 is used). Enter the setup menu of the external item (see manufacturers guide) and select the HDMI output. Select HDMI input on the TV and you should see a picture from the external item. When your setup is complete, remove the scart lead.

**Display.** The display contains over 1 million pixels. Do NOT hit or physically damage the screen surface. It is normal, within the lifetime of the screen to see bright or dark pixels. This is not a fault and is not covered by warranty.

**Service Port.** This connector is intended for service personnel only. Do NOT place any USB item into this port. You may upset the internal firmware. Unauthorised programming will invalidate your warranty.

## 13 : SPECIFICATIONS

---

Screen size	31.4" (79.7 cm)
Display type	TFT LCD
Resolution (Pixels)	1366 x 768
Aspect Ratio	16 X 9
Mains supply	100-240V AC 50.60Hz 0.77A (185W Max)
TV System	PAL / SECAM
TV antenna input	75 Ohms
Audio Output L/R	2 x 8W
Tuning Range (Analog)	Ch2 – Ch 4 Ch 5 – Ch 12 Ch 21 – Ch 69
Tuning Range (Digital)	Ch 21 – Ch 69
DVD disc size	12cm. (do not place 8cm).
Net weight	14.8 Kg's inc base
Overall Dimensions Inc base	805 x 570 x 250 mm
Remote control batteries	2 x "AAA" cells Alkaline.

Please note. The manufacturer reserves the right to improve specifications without notice.